

CD74HCT4514, CD74HCT4515 4-LINE TO 16-LINE DECODERS/DEMULTIPLEXERS WITH INPUT LATCHES

SCHS314D – MAY 2002 – REVISED SEPTEMBER 2004

- 4.5-V to 5.5-V V_{CC} Operation
- Fanout (Over Temperature Range)
 - Standard Outputs . . . 10 LSTTL Loads
 - Bus-Driver Outputs . . . 15 LSTTL Loads
- Wide Operating Temperature Range of -55°C to 125°C
- Balanced Propagation Delays and Transition Times
- Significant Power Reduction Compared to LSTTL Logic ICs
- HCT Types
 - Direct LSTTL Input Logic Compatibility, $V_{IL} = 0.8\text{ V (Max)}$, $V_{IH} = 2\text{ V (Min)}$
 - CMOS Input Compatibility, $I_I \leq 1\ \mu\text{A}$ at V_{OL} , V_{OH}

CD74HCT4514 . . . E PACKAGE
CD74HCT4515 . . . E OR EN PACKAGE
(TOP VIEW)

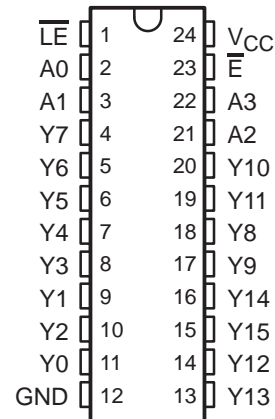

description/ordering information

The CD74HCT4514 and CD74HCT4515 are high-speed silicon-gate devices consisting of a 4-bit strobed latch and a 4-line to 16-line decoder. The selected output is enabled by a low on the enable (\bar{E}) input. A high on \bar{E} inhibits selection of any output. Demultiplexing is accomplished by using \bar{E} as the data input and the select inputs (A0–A3) as addresses. \bar{E} also serves as a chip select when these devices are cascaded.

When the latch enable (\bar{LE}) is high, the output follows changes in the inputs (see decode function table). When \bar{LE} is low, the output is isolated from changes in the input and remains at the level (high for the '4514, low for the '4515) it had before the latch was enabled.

ORDERING INFORMATION

T _A	PACKAGE†		ORDERABLE PART NUMBER	TOP-SIDE MARKING
	-55°C to 125°C	PDIP – E	Tube	CD74HCT4514E
CD74HCT4515E				CD74HCT4515E
PDIP – EN		Tube	CD74HCT4515EN	CD74HCT4515EN

† Package drawings, standard packing quantities, thermal data, symbolization, and PCB design guidelines are available at www.ti.com/sc/package.



Please be aware that an important notice concerning availability, standard warranty, and use in critical applications of Texas Instruments semiconductor products and disclaimers thereto appears at the end of this data sheet.

PRODUCTION DATA information is current as of publication date. Products conform to specifications per the terms of Texas Instruments standard warranty. Production processing does not necessarily include testing of all parameters.

 **TEXAS
INSTRUMENTS**

POST OFFICE BOX 655303 • DALLAS, TEXAS 75265

Copyright © 2004, Texas Instruments Incorporated

CD74HCT4514, CD74HCT4515 4-LINE TO 16-LINE DECODERS/DEMULTIPLEXERS WITH INPUT LATCHES

SCHS314D – MAY 2002 – REVISED SEPTEMBER 2004

DECODE FUNCTION TABLE
($\overline{LE} = H$)

\overline{E}	DECODER INPUTS				ADDRESSED OUTPUT CD74HCT4514 = H CD74HCT4515 = L
	A3	A2	A1	A0	
L	L	L	L	L	Y0
L	L	L	L	H	Y1
L	L	L	H	L	Y2
L	L	L	H	H	Y3
L	L	H	L	L	Y4
L	L	H	L	H	Y5
L	L	H	H	L	Y6
L	L	H	H	H	Y7
L	H	L	L	L	Y8
L	H	L	L	H	Y9
L	H	L	H	L	Y10
L	H	L	H	H	Y11
L	H	H	L	L	Y12
L	H	H	L	H	Y13
L	H	H	H	L	Y14
L	H	H	H	H	Y15
H	X	X	X	X	All outputs = L, CD74HCT4514 All outputs = H, CD74HCT4515

H = high, L = low, X = don't care

logic diagram (positive logic)

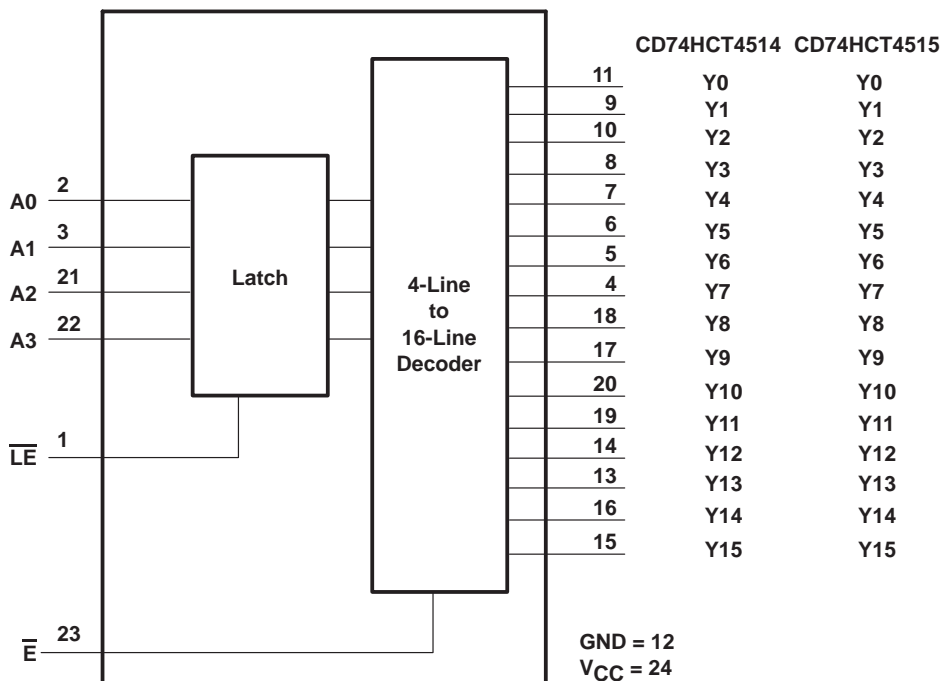

POST OFFICE BOX 655303 • DALLAS, TEXAS 75265

CD74HCT4514, CD74HCT4515 4-LINE TO 16-LINE DECODERS/DEMULTIPLEXERS WITH INPUT LATCHES

SCHS314D – MAY 2002 – REVISED SEPTEMBER 2004

absolute maximum ratings over operating free-air temperature range (unless otherwise noted)†

Supply voltage range, V_{CC}	–0.5 V to 7 V
Input clamp current, I_{IK} ($V_I < 0$ or $V_I > V_{CC}$) (see Note 1)	±20 mA
Output clamp current, I_{OK} ($V_O < 0$ or $V_O > V_{CC}$) (see Note 1)	±20 mA
Continuous output drain current per output, I_O ($V_O = 0$ to V_{CC})	±25 mA
Continuous output source or sink current per output, I_O ($V_O = 0$ to V_{CC})	±25 mA
Continuous current through V_{CC} or GND	±50 mA
Package thermal impedance, θ_{JA} (see Note 2): E package	67°C/W
EN package	67°C/W
Lead temperature 1,6 mm (1/16 inch) from case for 10 seconds	265°C
Storage temperature range, T_{stg}	–65°C to 150°C

† Stresses beyond those listed under “absolute maximum ratings” may cause permanent damage to the device. These are stress ratings only, and functional operation of the device at these or any other conditions beyond those indicated under “recommended operating conditions” is not implied. Exposure to absolute-maximum-rated conditions for extended periods may affect device reliability.

- NOTES: 1. The input and output voltage ratings may be exceeded if the input and output current ratings are observed.
2. The package thermal impedance is calculated in accordance with JESD 51-3.

recommended operating conditions (see Note 3)

	$T_A = 25^\circ\text{C}$		$T_A = -55^\circ\text{C}$ TO 125°C		$T_A = -40^\circ\text{C}$ TO 85°C		UNIT
	MIN	MAX	MIN	MAX	MIN	MAX	
V_{CC} Supply voltage	4.5	5.5	4.5	5.5	4.5	5.5	V
V_{IH} High-level input voltage	2		2		2		V
V_{IL} Low-level input voltage	0.8		0.8		0.8		V
V_I Input voltage	0	V_{CC}	0	V_{CC}	0	V_{CC}	V
V_O Output voltage	0	V_{CC}	0	V_{CC}	0	V_{CC}	V
$\Delta t/\Delta v$ Input transition rise or fall rate	500		500		500		ns

NOTE 3: All unused inputs of the device must be held at V_{CC} or GND to ensure proper device operation. Refer to the TI application report, *Implications of Slow or Floating CMOS Inputs*, literature number SCBA004.

electrical characteristics over recommended operating free-air temperature range (unless otherwise noted)

PARAMETER	TEST CONDITIONS		V_{CC}	$T_A = 25^\circ\text{C}$		$T_A = -55^\circ\text{C}$ TO 125°C		$T_A = -40^\circ\text{C}$ TO 85°C		UNIT
				MIN	MAX	MIN	MAX	MIN	MAX	
V_{OH}	$V_I = V_{IH}$ or V_{IL}	$I_{OH} = -20 \mu\text{A}$	4.5 V	4.4	4.4	4.4	4.4	4.4	V	
		$I_{OH} = -4 \text{ mA}$		3.98	3.7	3.84				
V_{OL}	$V_I = V_{IH}$ or V_{IL}	$I_{OL} = 20 \mu\text{A}$	4.5 V	0.1	0.1	0.1	0.1	V		
		$I_{OL} = 4 \text{ mA}$		0.26	0.4	0.33				
I_I	$V_I = V_{CC}$ or 0		5.5 V	±0.1	±1	±1	±1	μA		
I_{CC}	$V_I = V_{CC}$ or 0, $I_O = 0$		5.5 V	8	160	80	80	μA		
ΔI_{CC}^\ddagger	One input at $V_{CC} - 2.1 \text{ V}$, Other inputs at 0 or V_{CC}		4.5 V to 5.5 V	360	490	450	450	μA		
C_i				10	10	10	10	pF		

‡ Additional quiescent supply current per input pin, TTL inputs high, 1 unit load. For dual-supply systems, theoretical worst-case ($V_I = 2.4 \text{ V}$, $V_{CC} = 5.5 \text{ V}$) specification is 1.8 mA.



CD74HCT4514, CD74HCT4515

4-LINE TO 16-LINE DECODERS/DEMULTIPLEXERS

WITH INPUT LATCHES

SCHS314D – MAY 2002 – REVISED SEPTEMBER 2004

HCT INPUT LOADING TABLE

INPUT	UNIT LOAD
A0–A3	0.15
\overline{LE}	0.85
\overline{E}	0.3

Unit load is ΔI_{CC} limit specified in electrical characteristics table (e.g., 360 μ A max at 25°C).

timing requirements over recommended operating free-air temperature range, $V_{CC} = 4.5$ V, $C_L = 15$ pF (unless otherwise noted) (see Figure 1)

		$T_A = 25^\circ\text{C}$		$T_A = -55^\circ\text{C}$ TO 125°C		$T_A = -40^\circ\text{C}$ TO 85°C		UNIT
		MIN	MAX	MIN	MAX	MIN	MAX	
t_w	Pulse duration, \overline{LE} high	30		45		38		ns
t_{su}	Setup time, data before $\overline{LE}\downarrow$	20		30		25		ns
t_h	Hold time, data after $\overline{LE}\downarrow$	5		5		5		ns

switching characteristics over recommended operating free-air temperature range, $V_{CC} = 4.5$ V (unless otherwise noted) (see Figure 1)

PARAMETER	FROM (INPUT)	TO (OUTPUT)	LOAD CAPACITANCE	$T_A = 25^\circ\text{C}$		$T_A = -55^\circ\text{C}$ TO 125°C		$T_A = -40^\circ\text{C}$ TO 85°C		UNIT
				MIN	MAX	MIN	MAX	MIN	MAX	
t_{pd}	A0–A3	Y	$C_L = 50$ pF	55		83		69		ns
	\overline{LE}			50		75		63		
	\overline{E}			40		60		50		
t_t		Y	$C_L = 50$ pF	15		22		19	ns	

operating characteristics, $V_{CC} = 5$ V, $T_A = 25^\circ\text{C}$

PARAMETER	TYP	UNIT
C_{pd} Power dissipation capacitance	75	pF

CD74HCT4514, CD74HCT4515 4-LINE TO 16-LINE DECODERS/DEMULTIPLEXERS WITH INPUT LATCHES

SCHS314D – MAY 2002 – REVISED SEPTEMBER 2004

PARAMETER MEASUREMENT INFORMATION

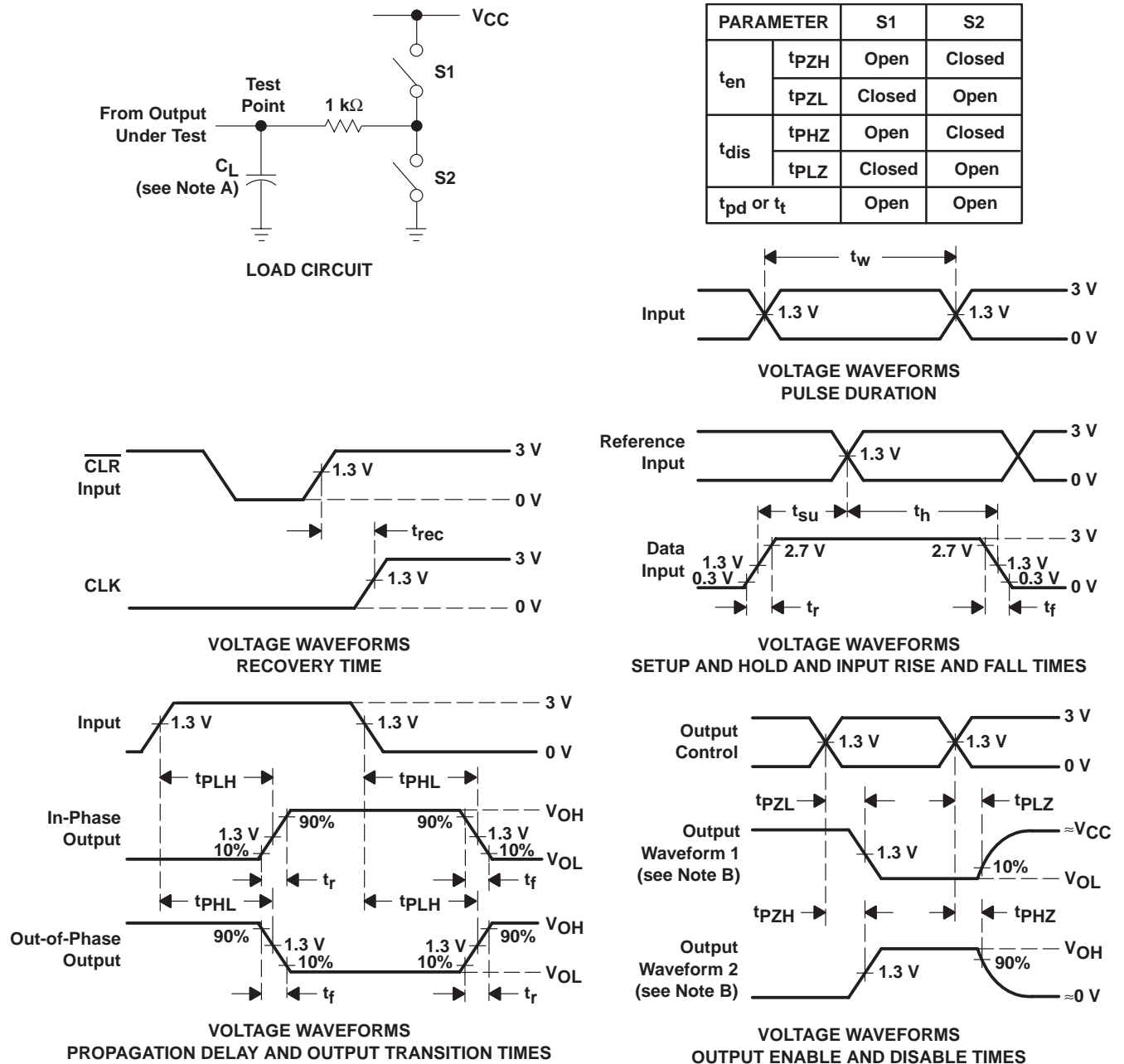

- NOTES:
- A. C_L includes probe and test-fixture capacitance.
 - B. Waveform 1 is for an output with internal conditions such that the output is low, except when disabled by the output control. Waveform 2 is for an output with internal conditions such that the output is high, except when disabled by the output control.
 - C. Phase relationships between waveforms were chosen arbitrarily. All input pulses are supplied by generators having the following characteristics: $PRR \leq 1$ MHz, $Z_O = 50 \Omega$, $t_r = 6$ ns, $t_f = 6$ ns.
 - D. For clock inputs, f_{max} is measured with the input duty cycle at 50%.
 - E. The outputs are measured one at a time, with one input transition per measurement.
 - F. $tpLZ$ and $tpHZ$ are the same as t_{dis} .
 - G. $tpZL$ and $tpZH$ are the same as t_{en} .
 - H. $tpLH$ and $tpHL$ are the same as t_{pd} .

Figure 1. Load Circuit and Voltage Waveforms

PACKAGING INFORMATION

Orderable Device	Status ⁽¹⁾	Package Type	Package Drawing	Pins	Package Qty	Eco Plan ⁽²⁾	Lead/Ball Finish	MSL Peak Temp ⁽³⁾
CD74HCT4514E	ACTIVE	PDIP	N	24	15	Pb-Free (RoHS)	CU NIPDAU	N / A for Pkg Type
CD74HCT4514EE4	ACTIVE	PDIP	N	24	15	Pb-Free (RoHS)	CU NIPDAU	N / A for Pkg Type
CD74HCT4515E	ACTIVE	PDIP	N	24	15	Pb-Free (RoHS)	CU NIPDAU	N / A for Pkg Type
CD74HCT4515EE4	ACTIVE	PDIP	N	24	15	Pb-Free (RoHS)	CU NIPDAU	N / A for Pkg Type
CD74HCT4515EN	ACTIVE	PDIP	NT	24	15	Pb-Free (RoHS)	CU NIPDAU	N / A for Pkg Type
CD74HCT4515ENE4	ACTIVE	PDIP	NT	24	15	Pb-Free (RoHS)	CU NIPDAU	N / A for Pkg Type

⁽¹⁾ The marketing status values are defined as follows:

ACTIVE: Product device recommended for new designs.

LIFEBUY: TI has announced that the device will be discontinued, and a lifetime-buy period is in effect.

NRND: Not recommended for new designs. Device is in production to support existing customers, but TI does not recommend using this part in a new design.

PREVIEW: Device has been announced but is not in production. Samples may or may not be available.

OBSOLETE: TI has discontinued the production of the device.

⁽²⁾ Eco Plan - The planned eco-friendly classification: Pb-Free (RoHS), Pb-Free (RoHS Exempt), or Green (RoHS & no Sb/Br) - please check <http://www.ti.com/productcontent> for the latest availability information and additional product content details.

TBD: The Pb-Free/Green conversion plan has not been defined.

Pb-Free (RoHS): TI's terms "Lead-Free" or "Pb-Free" mean semiconductor products that are compatible with the current RoHS requirements for all 6 substances, including the requirement that lead not exceed 0.1% by weight in homogeneous materials. Where designed to be soldered at high temperatures, TI Pb-Free products are suitable for use in specified lead-free processes.

Pb-Free (RoHS Exempt): This component has a RoHS exemption for either 1) lead-based flip-chip solder bumps used between the die and package, or 2) lead-based die adhesive used between the die and leadframe. The component is otherwise considered Pb-Free (RoHS compatible) as defined above.

Green (RoHS & no Sb/Br): TI defines "Green" to mean Pb-Free (RoHS compatible), and free of Bromine (Br) and Antimony (Sb) based flame retardants (Br or Sb do not exceed 0.1% by weight in homogeneous material)

⁽³⁾ MSL, Peak Temp. -- The Moisture Sensitivity Level rating according to the JEDEC industry standard classifications, and peak solder temperature.

Important Information and Disclaimer:The information provided on this page represents TI's knowledge and belief as of the date that it is provided. TI bases its knowledge and belief on information provided by third parties, and makes no representation or warranty as to the accuracy of such information. Efforts are underway to better integrate information from third parties. TI has taken and continues to take reasonable steps to provide representative and accurate information but may not have conducted destructive testing or chemical analysis on incoming materials and chemicals. TI and TI suppliers consider certain information to be proprietary, and thus CAS numbers and other limited information may not be available for release.

In no event shall TI's liability arising out of such information exceed the total purchase price of the TI part(s) at issue in this document sold by TI to Customer on an annual basis.

N (R-PDIP-T24)

PLASTIC DUAL-IN-LINE

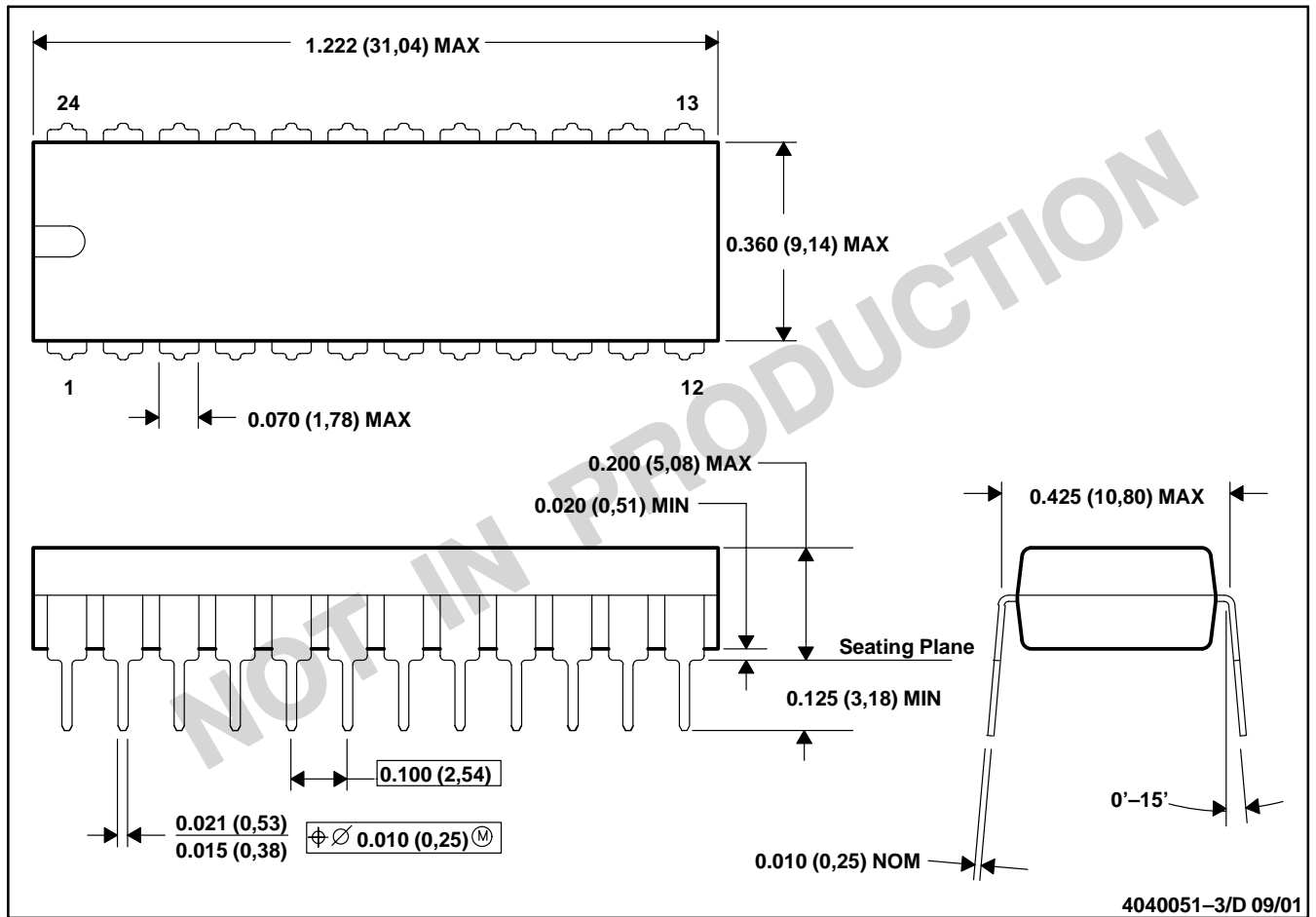



- NOTES: A. All linear dimensions are in inches (millimeters).
 B. This drawing is subject to change without notice.
 C. Falls within JEDEC MS-010

MECHANICAL DATA

NT (R-PDIP-T**) 24 PINS SHOWN

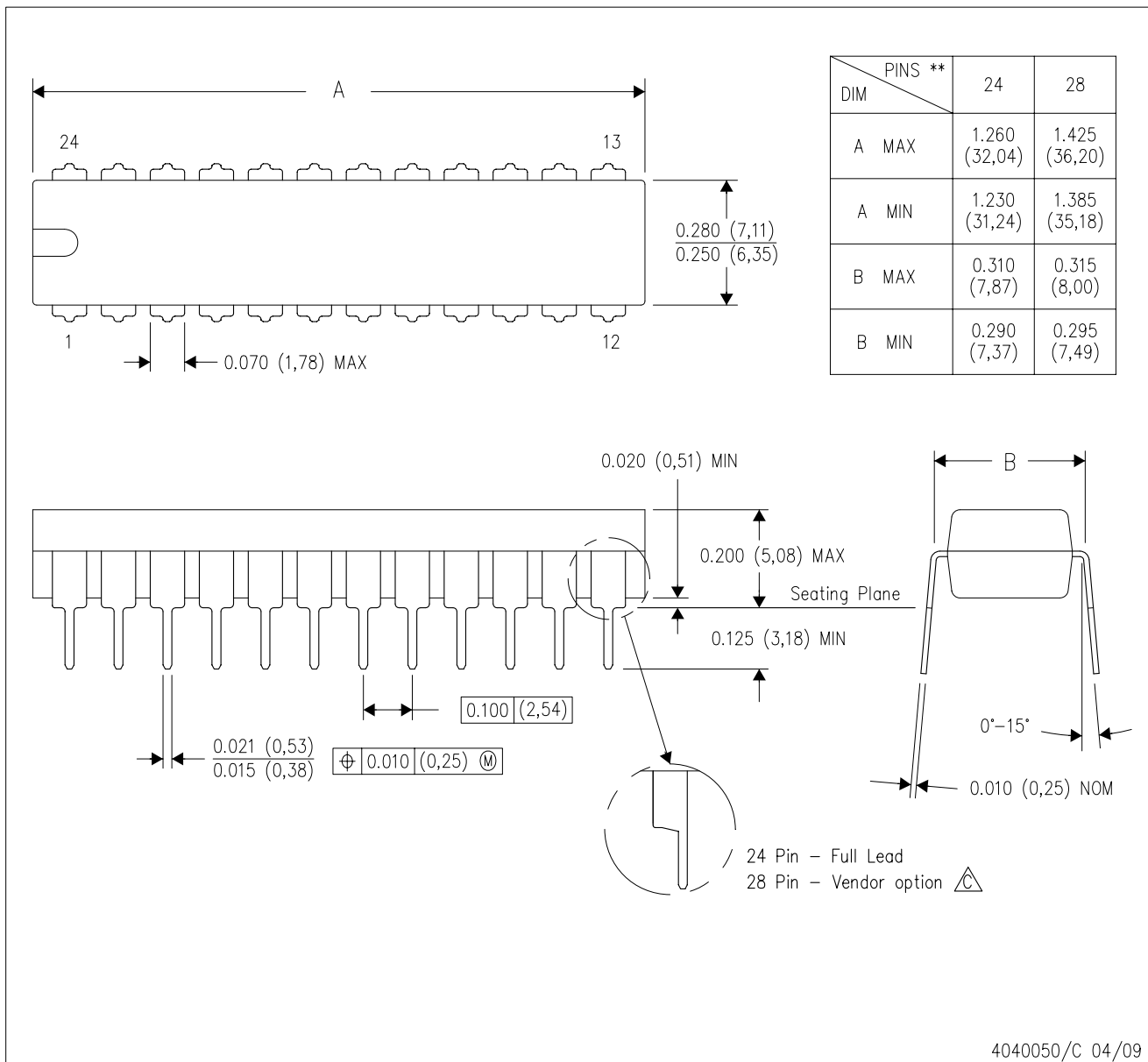
PLASTIC DUAL-IN-LINE PACKAGE



- NOTES:
- A. All linear dimensions are in millimeters. Dimensioning and tolerancing per ASME Y14.5M-1994.
 - B. This drawing is subject to change without notice.
 -  The 28 pin end lead shoulder width is a vendor option, either half or full width.

N (R-PDIP-T)**

PLASTIC DUAL-IN-LINE PACKAGE

24 PIN SHOWN

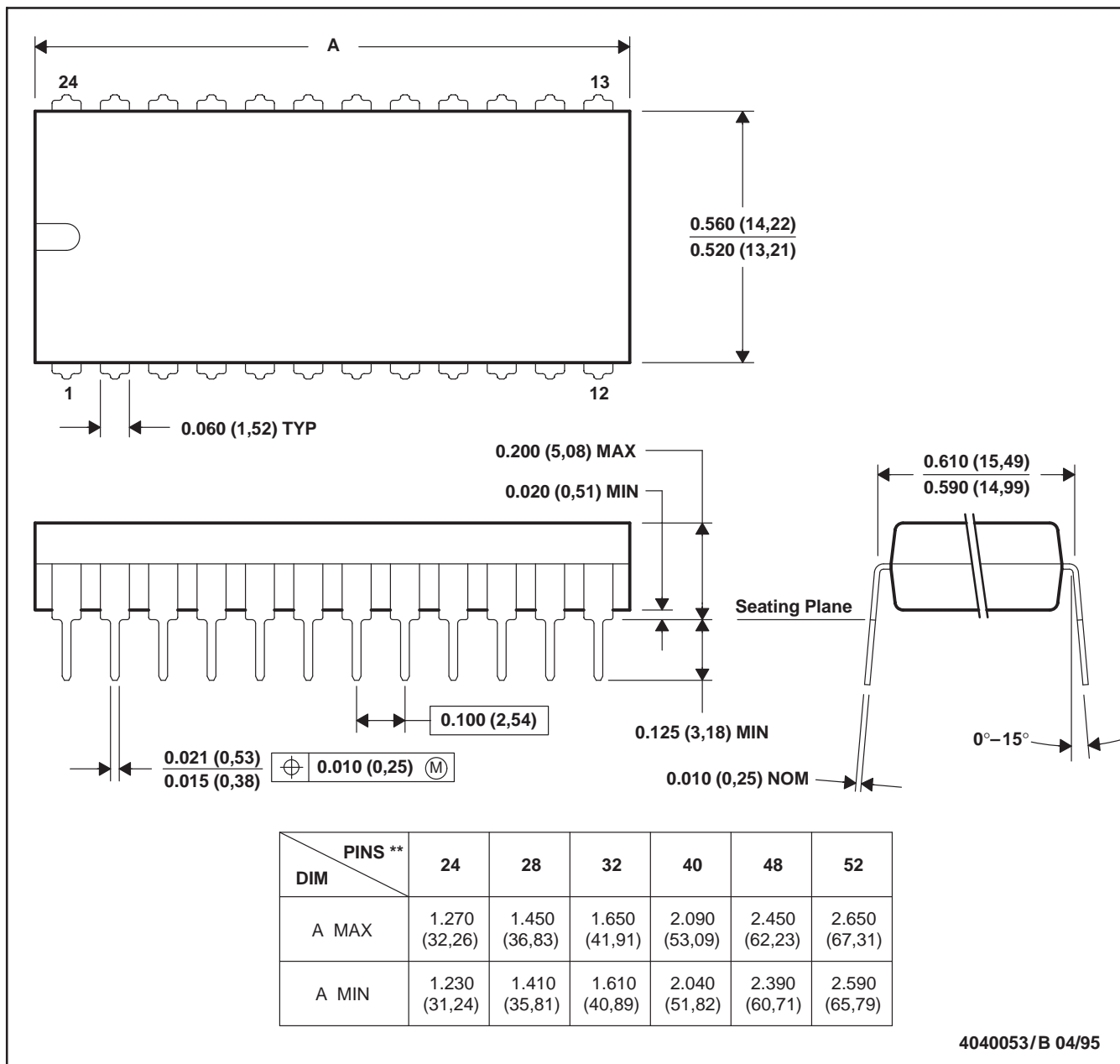

- NOTES: A. All linear dimensions are in inches (millimeters).
 B. This drawing is subject to change without notice.
 C. Falls within JEDEC MS-011
 D. Falls within JEDEC MS-015 (32 pin only)

IMPORTANT NOTICE

Texas Instruments Incorporated and its subsidiaries (TI) reserve the right to make corrections, modifications, enhancements, improvements, and other changes to its products and services at any time and to discontinue any product or service without notice. Customers should obtain the latest relevant information before placing orders and should verify that such information is current and complete. All products are sold subject to TI's terms and conditions of sale supplied at the time of order acknowledgment.

TI warrants performance of its hardware products to the specifications applicable at the time of sale in accordance with TI's standard warranty. Testing and other quality control techniques are used to the extent TI deems necessary to support this warranty. Except where mandated by government requirements, testing of all parameters of each product is not necessarily performed.

TI assumes no liability for applications assistance or customer product design. Customers are responsible for their products and applications using TI components. To minimize the risks associated with customer products and applications, customers should provide adequate design and operating safeguards.

TI does not warrant or represent that any license, either express or implied, is granted under any TI patent right, copyright, mask work right, or other TI intellectual property right relating to any combination, machine, or process in which TI products or services are used. Information published by TI regarding third-party products or services does not constitute a license from TI to use such products or services or a warranty or endorsement thereof. Use of such information may require a license from a third party under the patents or other intellectual property of the third party, or a license from TI under the patents or other intellectual property of TI.

Reproduction of TI information in TI data books or data sheets is permissible only if reproduction is without alteration and is accompanied by all associated warranties, conditions, limitations, and notices. Reproduction of this information with alteration is an unfair and deceptive business practice. TI is not responsible or liable for such altered documentation. Information of third parties may be subject to additional restrictions.

Resale of TI products or services with statements different from or beyond the parameters stated by TI for that product or service voids all express and any implied warranties for the associated TI product or service and is an unfair and deceptive business practice. TI is not responsible or liable for any such statements.

TI products are not authorized for use in safety-critical applications (such as life support) where a failure of the TI product would reasonably be expected to cause severe personal injury or death, unless officers of the parties have executed an agreement specifically governing such use. Buyers represent that they have all necessary expertise in the safety and regulatory ramifications of their applications, and acknowledge and agree that they are solely responsible for all legal, regulatory and safety-related requirements concerning their products and any use of TI products in such safety-critical applications, notwithstanding any applications-related information or support that may be provided by TI. Further, Buyers must fully indemnify TI and its representatives against any damages arising out of the use of TI products in such safety-critical applications.

TI products are neither designed nor intended for use in military/aerospace applications or environments unless the TI products are specifically designated by TI as military-grade or "enhanced plastic." Only products designated by TI as military-grade meet military specifications. Buyers acknowledge and agree that any such use of TI products which TI has not designated as military-grade is solely at the Buyer's risk, and that they are solely responsible for compliance with all legal and regulatory requirements in connection with such use.

TI products are neither designed nor intended for use in automotive applications or environments unless the specific TI products are designated by TI as compliant with ISO/TS 16949 requirements. Buyers acknowledge and agree that, if they use any non-designated products in automotive applications, TI will not be responsible for any failure to meet such requirements.

Following are URLs where you can obtain information on other Texas Instruments products and application solutions:

Products

Amplifiers	amplifier.ti.com
Data Converters	dataconverter.ti.com
DLP® Products	www.dlp.com
DSP	dsp.ti.com
Clocks and Timers	www.ti.com/clocks
Interface	interface.ti.com
Logic	logic.ti.com
Power Mgmt	power.ti.com
Microcontrollers	microcontroller.ti.com
RFID	www.ti-rfid.com
RF/IF and ZigBee® Solutions	www.ti.com/lprf

Applications

Audio	www.ti.com/audio
Automotive	www.ti.com/automotive
Broadband	www.ti.com/broadband
Digital Control	www.ti.com/digitalcontrol
Medical	www.ti.com/medical
Military	www.ti.com/military
Optical Networking	www.ti.com/opticalnetwork
Security	www.ti.com/security
Telephony	www.ti.com/telephony
Video & Imaging	www.ti.com/video
Wireless	www.ti.com/wireless

Mailing Address: Texas Instruments, Post Office Box 655303, Dallas, Texas 75265
Copyright © 2009, Texas Instruments Incorporated