

Stereo Power Amplifier/Monaural BTL Power Amplifier

Description

The CXA1622P/M is a bipolar IC developed as power amplifier for compact radio cassettes with built-in pre-amplifier and power amplifier electrical volume.

Features

- Use one channel in stereo mode
 - EIAJ output=450 mW (Typ.), $V_{CC}=6\text{ V}$, $R_L=8\ \Omega$ (CXA1622P)
 - EIAJ output=110 mW (Typ.), $V_{CC}=3\text{ V}$, $R_L=8\ \Omega$ (CXA1622M)
- BTL mode
 - EIAJ output=360 mW (Typ.), $V_{CC}=3\text{ V}$, $R_L=8\ \Omega$ (CXA1622P)
 - EIAJ output=320 mW (Typ.), $V_{CC}=3\text{ V}$, $R_L=8\ \Omega$ (CXA1622M)
- Built-in electrical volume
- Built-in ripple filter (ripple rejection 34.5 dB typ.)
- Selection between stereo power amplifier and monaural BTL power amplifier is possible by switching Pin 2.

Applications

Suitable for audio power amplifier for stereo and monaural radios and power amplifier for radio cassette and walkman.

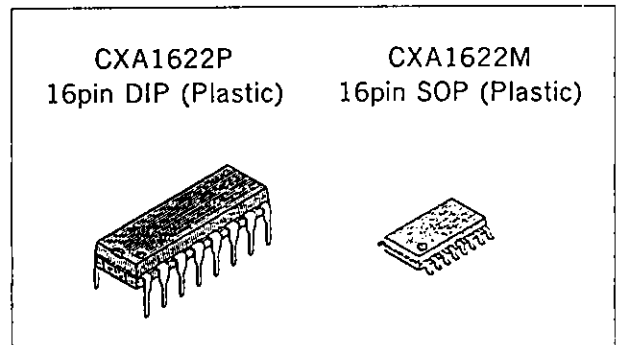

Structure

Bipolar silicon monolithic IC

Absolute Maximum Ratings ($T_a=25\ ^\circ\text{C}$)

• Supply voltage	V_{CC}	8	V
• Operating temperature	T_{OPR}	-10 to +60	$^\circ\text{C}$
• Storage temperature	T_{STG}	-65 to +150	$^\circ\text{C}$
• Allowable power dissipation	P_D	1200 (CXA1622P) mW 410 (CXA1622M) mW	

Operating Conditions ($T_a=25\ ^\circ\text{C}$)

Supply voltage

Stereo mode	1.8V to 7.0V (CXA1622P)
	1.8V to 4.5V (CXA1622M)
Monaural BTL mode	1.8V to 4.5V

(3V recommended)

CXA1622P/M

Power dissipation curve

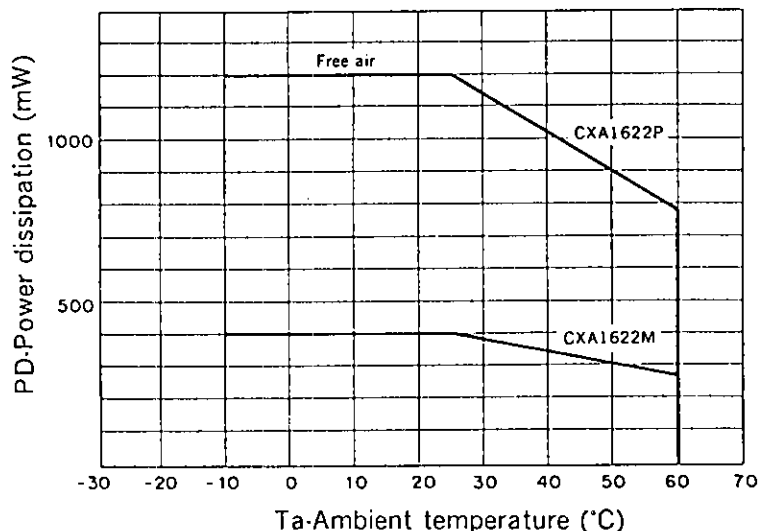

Pin Description

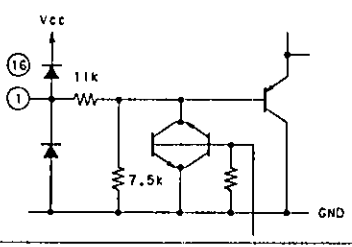
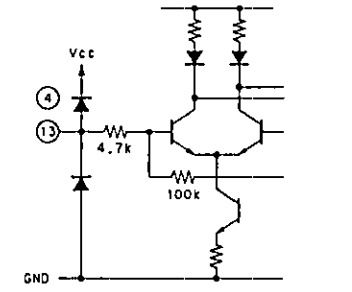
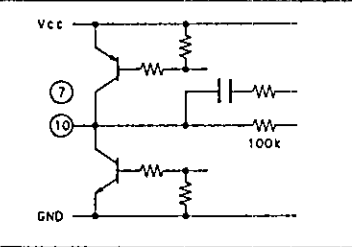
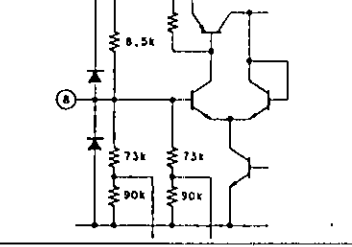
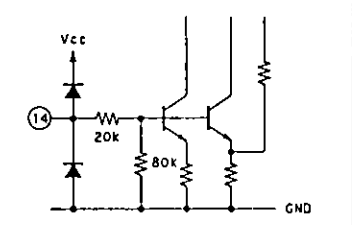
Pin No.	Symbol	Equivalent circuit	Pin voltage		Description
			3V	6V	
1, 16	IN1 IN2		0	0	Input
3	NC		—	—	
4, 13	NF1 NF2		1.5	3	Power amplifier NF. Connected to time constant 4.7 μ F.
5, 12	CND1 CND2		0	0	Pre-amplifier GND
6, 11	P-GND1 P-GND2		0	0	Power amplifier GND
7, 10	OUT1 OUT2		1.5	3	Power amplifier output
8	RIPPLE		2.72	5.43	Connected to time constant 10 μ F for ripple filter.
9	V _{CC}		3	6	V _{CC}
14	VOL		0 to 1.25	0 to 1.25	Control gain with change in voltage (0 to 1.25 V) to electrical volume control pin

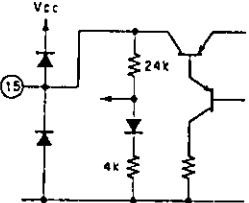
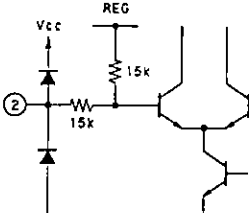
Pin No.	Symbol	Equivalent circuit	Pin voltage		Description
			3V	6V	
15	REG		1.25	1.25	Regulator pin
2	SW		1.25	1.25	Mode selection SW • BTL mode when open • Stereo mode when connected to GND

Block Diagram, Pin Configuration, and Application Circuit

1) Stereo mode

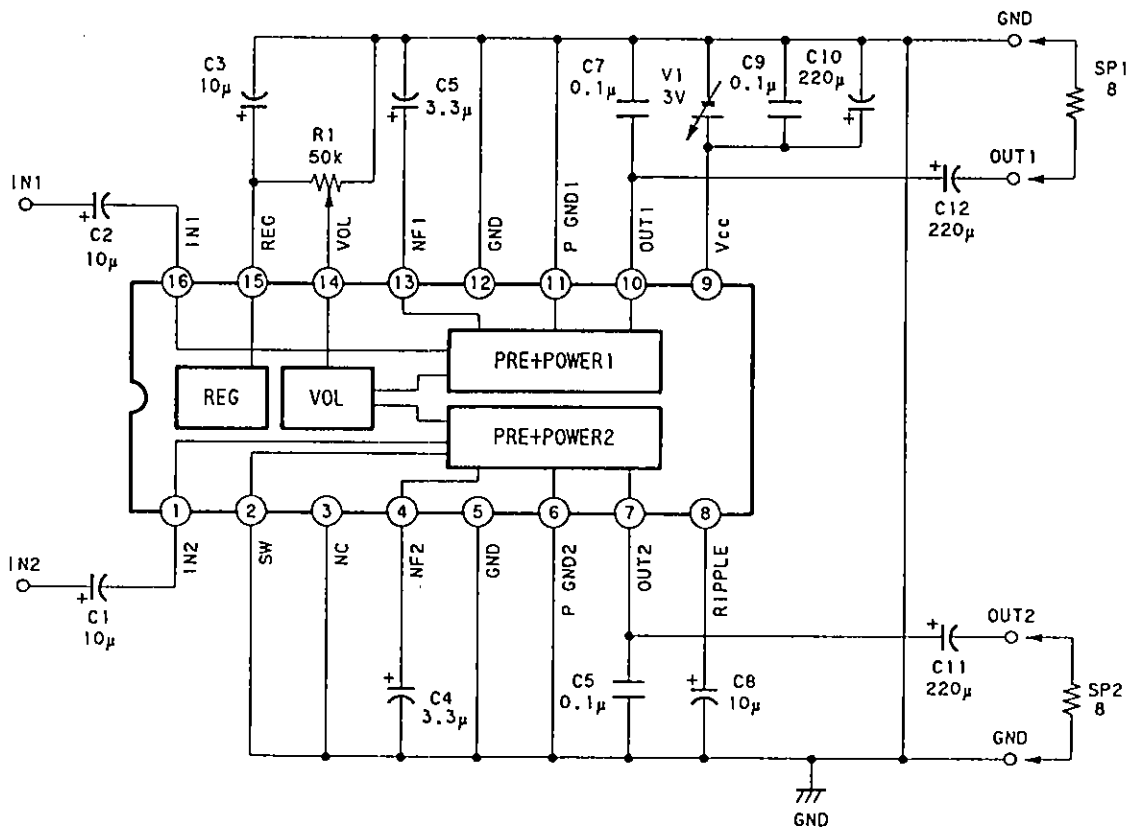

2) BTL mode

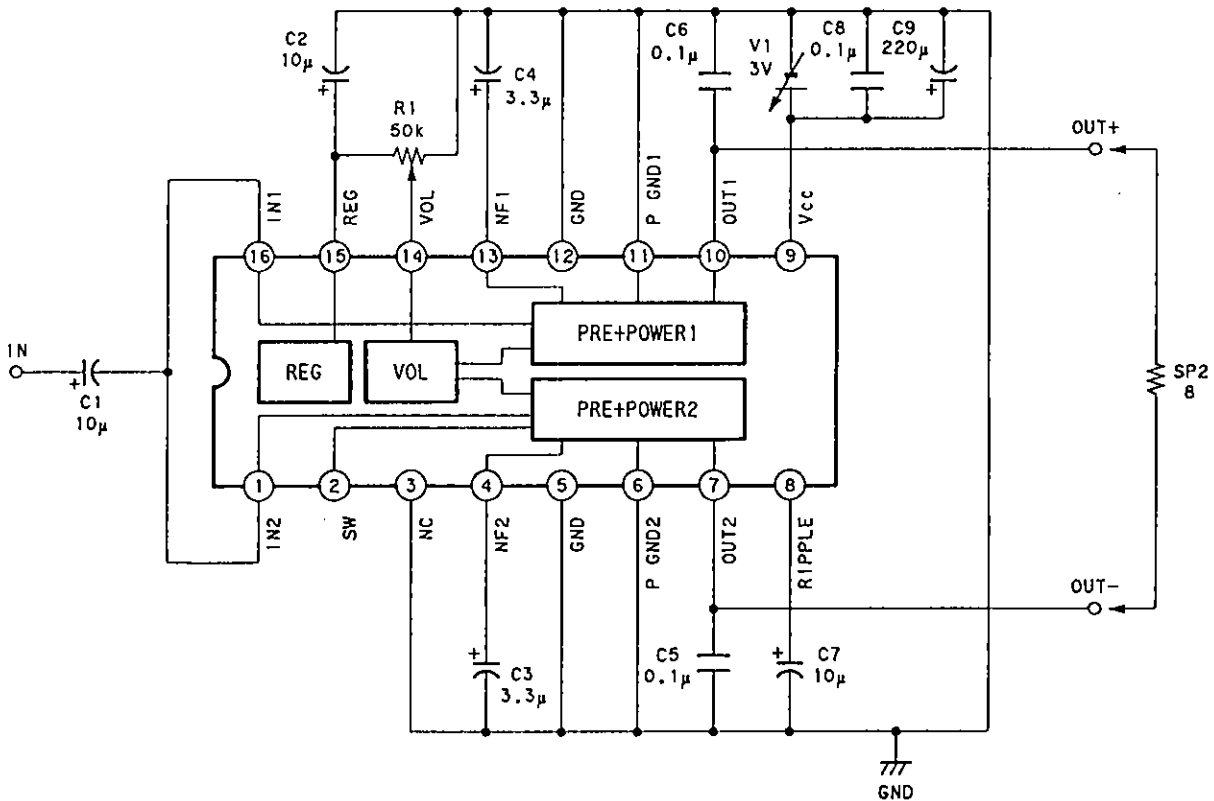

- * The input signal enters the pre-amplifier with attenuation controlled with DC at Pin 14 and then it is amplified by the approximately 30 dB (fixed) power amplifier.
- * The state of Pin 2 can be used to select between stereo mode and monaural BTL mode. The pre-power 1 and pre-power 2 output are positive phase output when Pin 2 is GND. Pre-power 2 is inverse output of pre-power 1 output when Pin 2 is open.

Stereo mode { Upper : CXA1622P (Vcc=6V)
Lower : CXA1622M (Vcc=3V)

Function block	TEST No.	Test item	BIAS SW Conditions														Input point	Input waveform and Bias description	Test point	Output waveform and Description of test method	Min.	Typ.	Max.	Unit							
			S ₁	S ₂	S ₃	S ₄	S ₅	S ₆	S ₇	S ₈	S ₉	S ₁₀	S ₁₁	S ₁₂	S ₁₃	S ₁₄															
		Typical conditions for each bias																													
	1	Circuit current during no signal	OFF	OFF	OFF	ON	OFF	OFF	OFF	OFF	OFF	OFF	OFF	OFF	OFF	OFF	OFF	OFF	I ₁	Circuit current during no signal	1.0	3.0	8.2	mA							
	2	Audio voltage gain Lch	ON	ON	OFF														V ₄	V ₁ = -40 dBm 1kHz	28	33.7	38	dB							
	3	Audio voltage gain Rch	OFF	OFF	ON														V ₅	V ₁ = -40 dBm 1kHz	28	33.7	38	dB							
	4	Channel balance																	V ₄ , V ₅	L and R channel balance	-3	0	-3	dB							
	5	Attenuation Lch	ON	ON	OFF	ON													V ₄	V ₁ = -40 dBm 1kHz Output level difference between max volume and half volume	1.5	5.8	12	dB							
	6	Attenuation Rch	OFF	OFF	ON														V ₅	V ₁ = -40 dBm 1kHz Output level difference between max volume and half volume	1.5	5.8	12	dB							
	7	EIAJ output Lch	ON	ON	OFF	ON													V ₆	V ₁ = -20 dBm 1kHz, RL=8Ω Output level where THD=10%	350	450		mW							
	8	EIAJ output Rch	OFF	OFF	ON														V ₅	V ₁ = -20 dBm 1kHz, RL=8Ω Output level where THD=10%	350	450		mW							
	9	Audio distortion factor Lch	ON	ON	OFF	ON													V ₄	V ₁ = -20 dBm 1kHz, RL=8Ω Distortion factor when output is 50 mW		0.7	2.5	%							
	10	Audio distortion factor Rch	ON	ON	OFF	ON													V ₅	V ₁ = -20 dBm 1kHz, RL=8Ω Distortion factor when output is 50 mW		0.7	2.5	%							
	11	Residual noise level Lch	OFF	OFF	OFF	OFF													V ₄	Noise level during no signal at max volume		-65	-60	dBm							
	12	Residual noise level Rch																	V ₅	Noise level during no signal at max volume		-65	-60	dBm							
	13	Crosstalk L → R	ON	ON	ON															V ₁ = -40 dBm 1kHz Rch output level when Lch is input		-60	-56	dBm							
	14	Crosstalk R → L	OFF	OFF	ON															V ₁ = -40 dBm 1kHz Lch output level when Rch is input		-60	-56	dBm							

BTL mode $V_{CC} = 3V$
 Upper : CXA1622P
 Lower : CXA1622M

Function block	TEST No.	Test item	BIAS SW Conditions														Input point	Input waveform and Bias description	Test point	Output waveform and Description of test method	Min.	Typ.	Max.	Unit
			S ₁	S ₂	S ₃	S ₄	S ₅	S ₆	S ₇	S ₈	S ₉	S ₁₀	S ₁₁	S ₁₂	S ₁₃	S ₁₄								
		Typical conditions for each bias																						
	1	Circuit current during no signal	OFF	ON	ON	OFF	OFF	OFF	OFF	OFF	OFF	ON	ON	ON	ON	ON	OFF	OFF	1 _i	Circuit current during no signal	3	7	mA	
	2	OUTPUT DC bias lag														ON			V _s	Output DC bias lag	0	30	mV	
	3	Audio voltage gain	ON																V _s	V _i = -40 dBm 1 kHz	34	38	42	dB
	4	Attenuation															ON		V _s	V _i = -40 dBm 1 kHz Output level difference between max volume and half volume	1.5	6.0	12	dB
	5	EIAJ output															ON		V _s	V _i = -20 dBm 1 kHz, RL = 8Ω Output level where THD = 10 %	260	360		mW
	6	Audio distortion factor																	V _s	V _i = -20 dBm 1 kHz, RL = 8Ω Distortion factor when output is 50 mW		1.0	2.5	%
	7	Residual noise level															OFF	OFF	V _s	Noise level during no signal at max volume		-65	-62	dBm

Electrical Characteristics Test Circuit

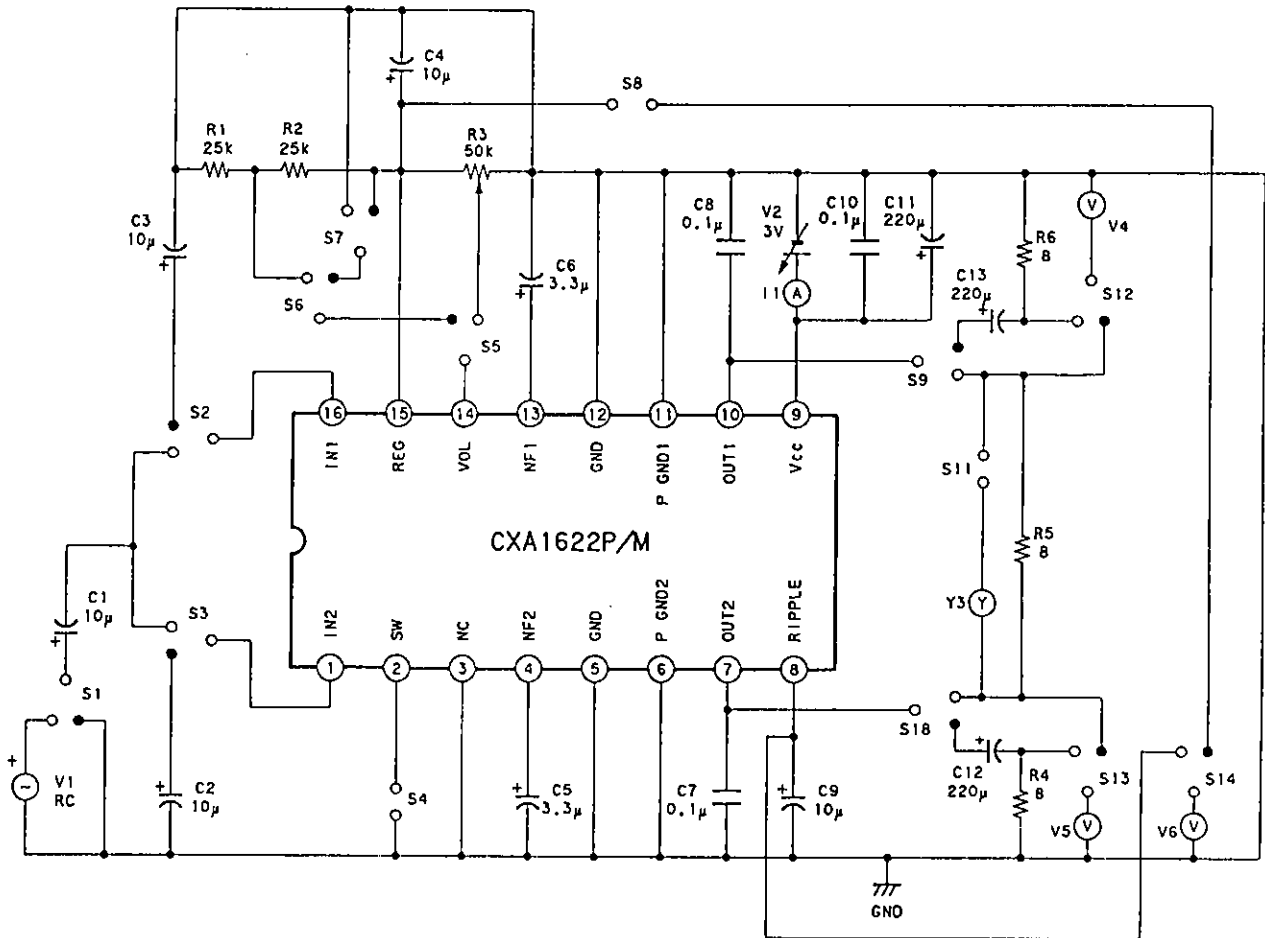

Notes on Operation

- Set print pattern to low impedance because Pins 6 and 11 are GND of power amplifier output stage.
- The value of the phase correction capacitance attached to Pins 7 and 10 varies slightly according to the print pattern.
- Provide a large land for DIP type Pin 5 because it also serves as heat dissipation pin.
- Place the by-pass capacitor of V_{CC} (Pin 9) as close to the pin as possible.

Stereo output single mode

* Keep the by-pass capacitor close to the IC pins

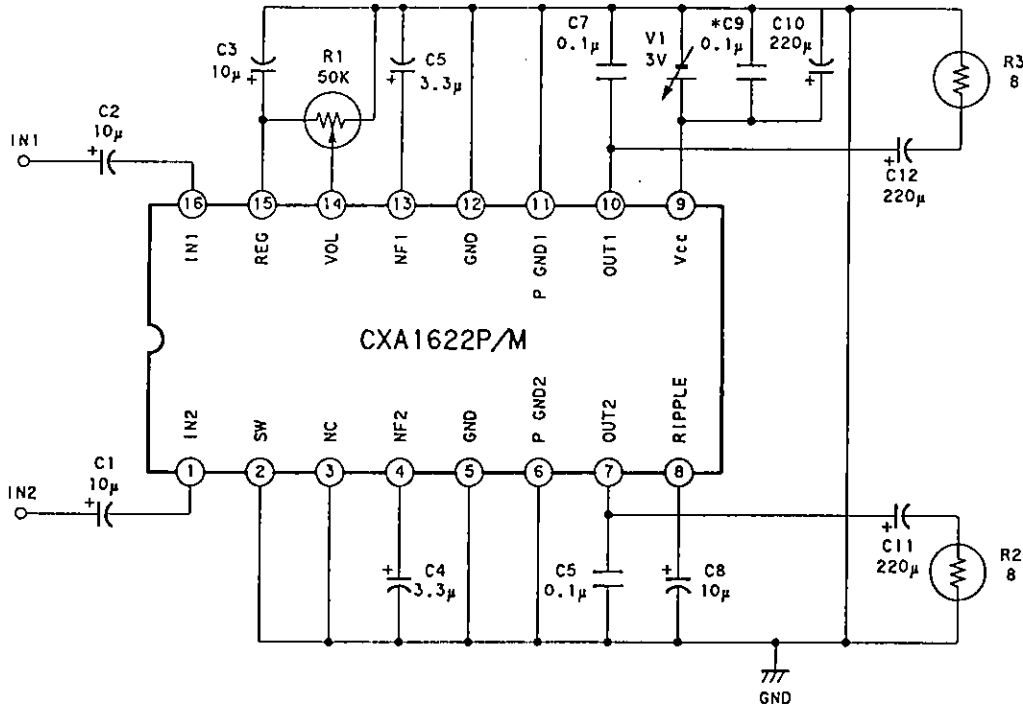

Monaural output BTL mode

* Keep the by-pass capacitor close to the IC pins

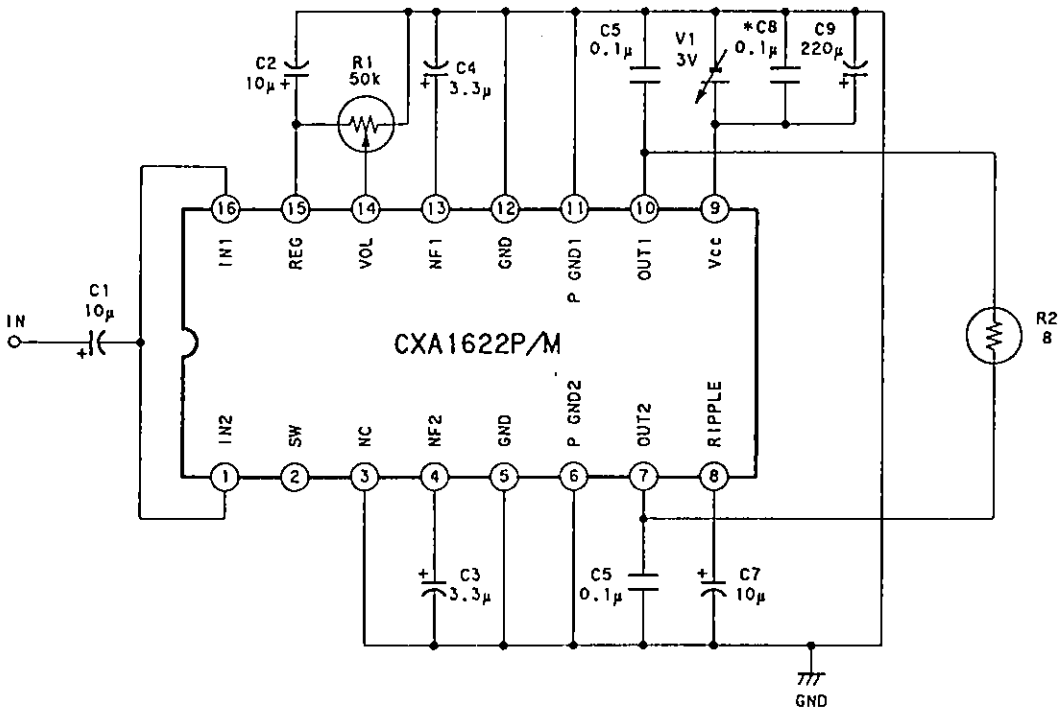

When using internal IC electrical volume in BTL mode

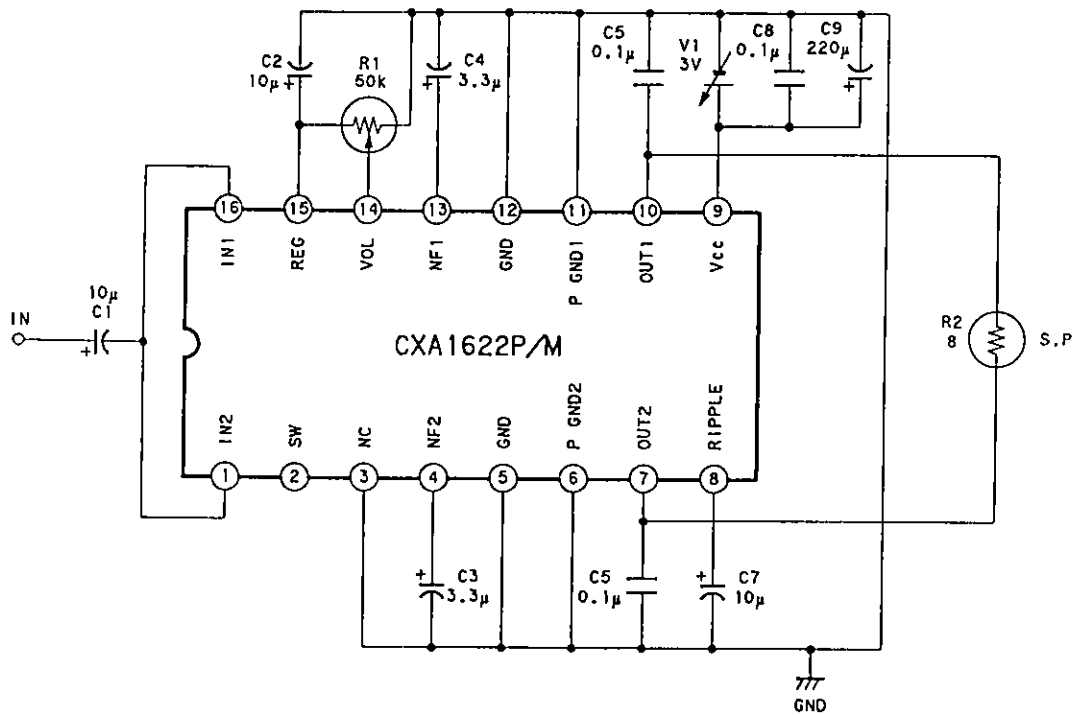

When using IC as fixed gain amplifier in BTL mode

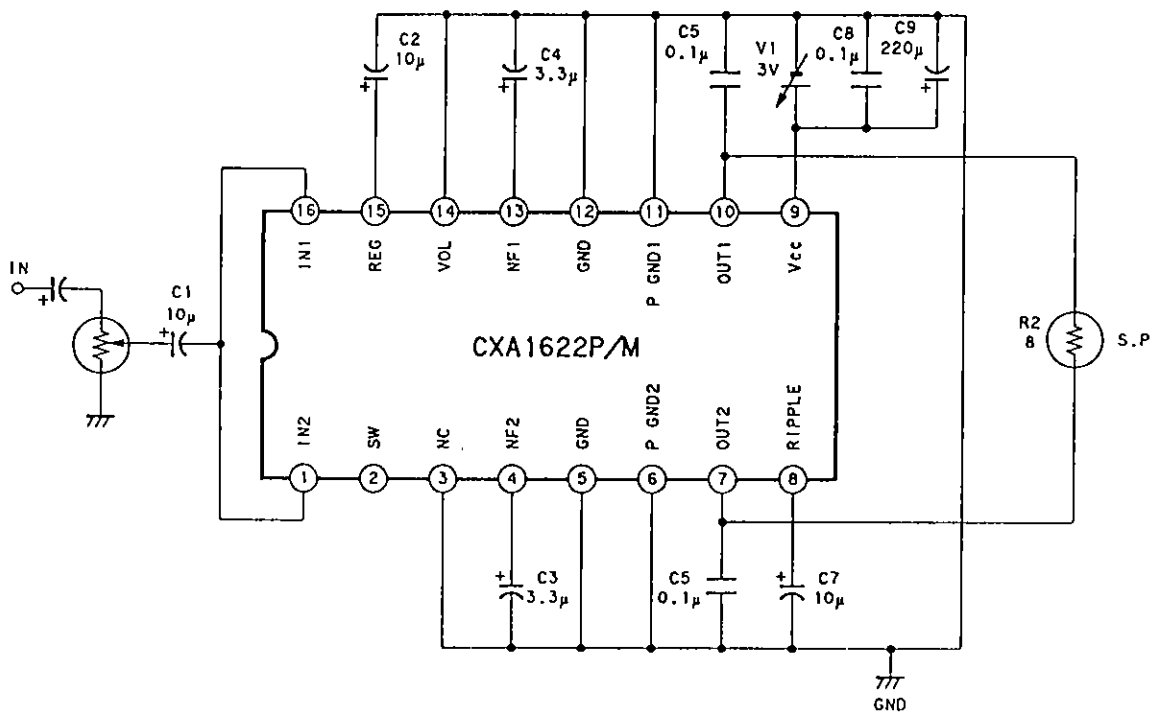

BTL, Stereo Application Circuit

When using internal IC electrical volume

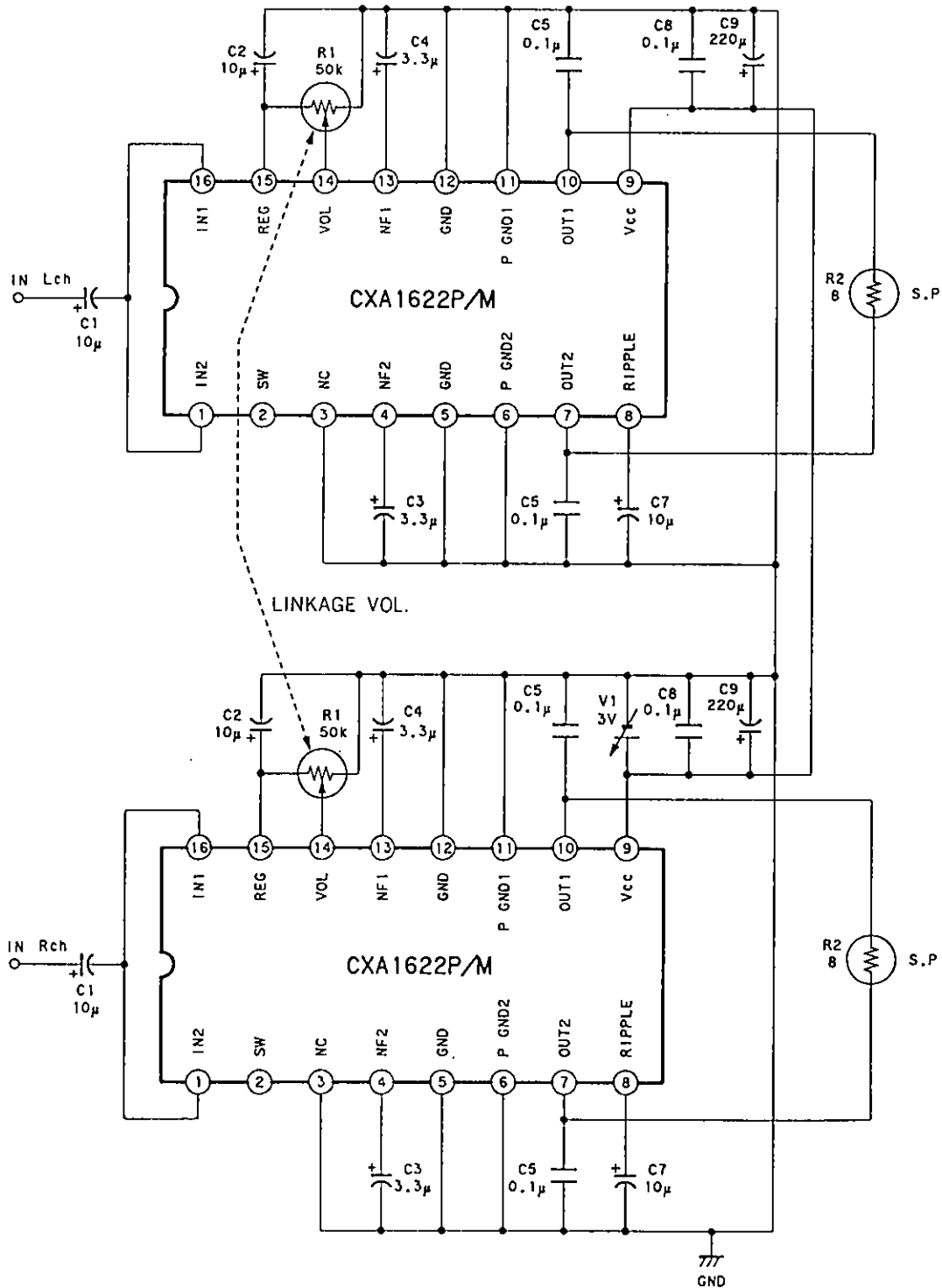

Application circuits shown are typical examples illustrating the operation of the devices. Sony cannot assume responsibility for any problems arising out of the use of these circuits or for any infringement of third party patent and other right due to same.

BTL, Stereo Application Circuit

When using IC as fixed gain amplifier

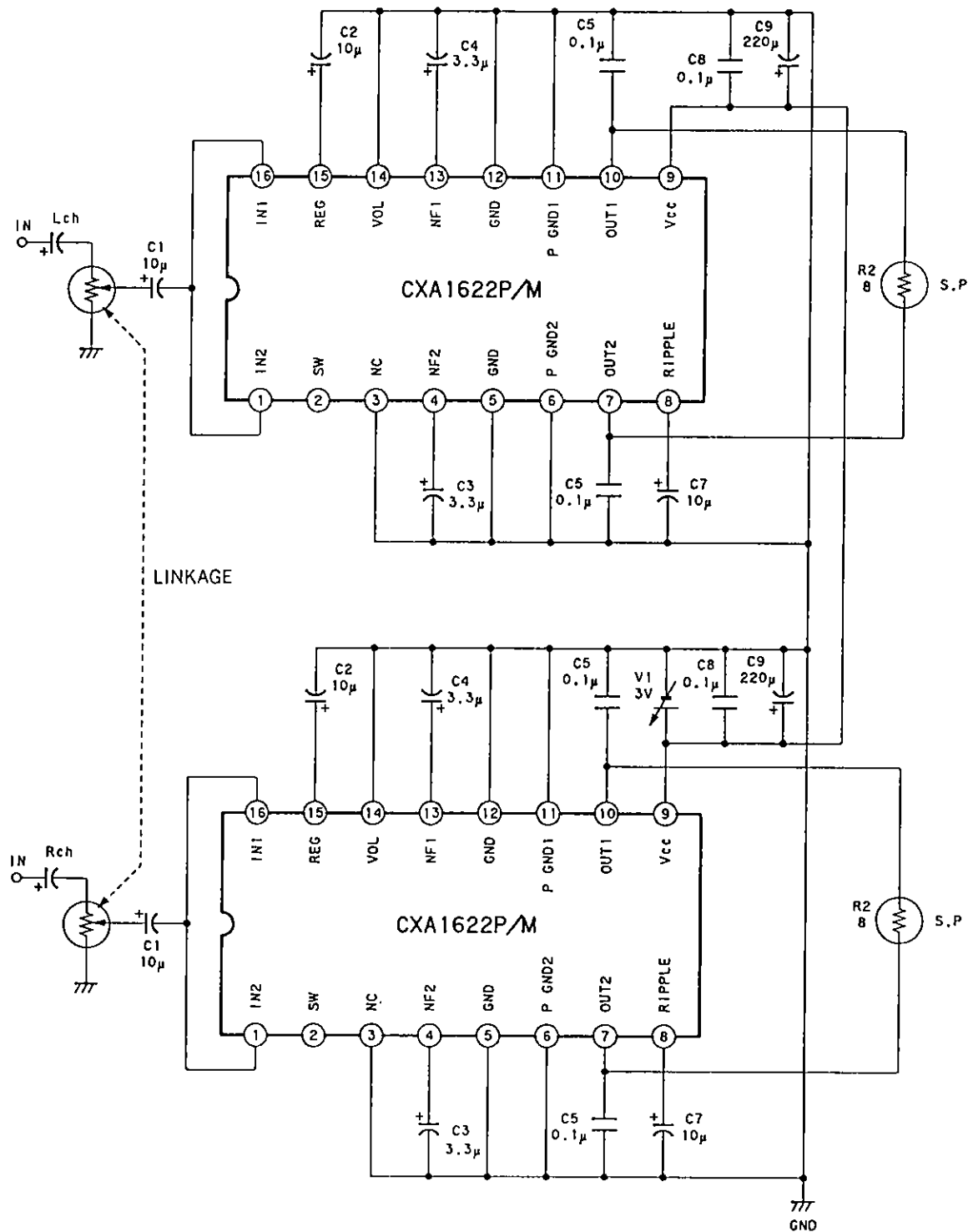

Application circuits shown are typical examples illustrating the operation of the devices. Sony cannot assume responsibility for any problems arising out of the use of these circuits or for any infringement of third party patent and other right due to same.

Output vs Distortion 1 A1622P
stereo mode single-channel input

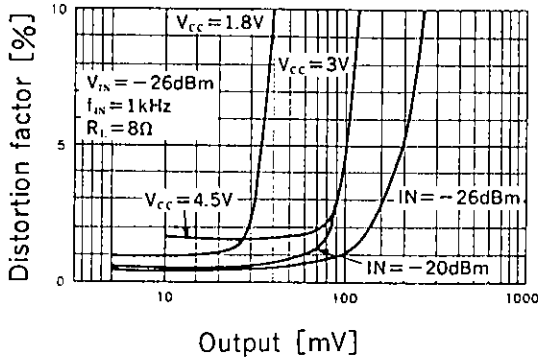

Output vs Distortion factor 2 A1622M
stereo mode single-channel input

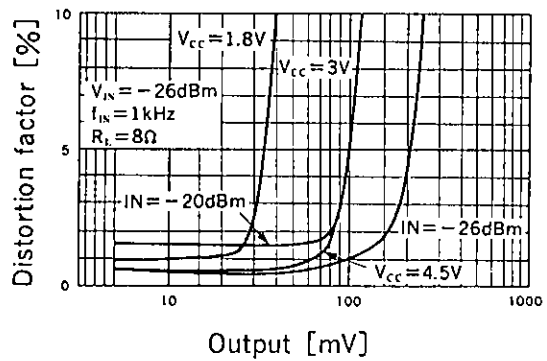

Output vs Distortion factor 3
A1622P BTL mode

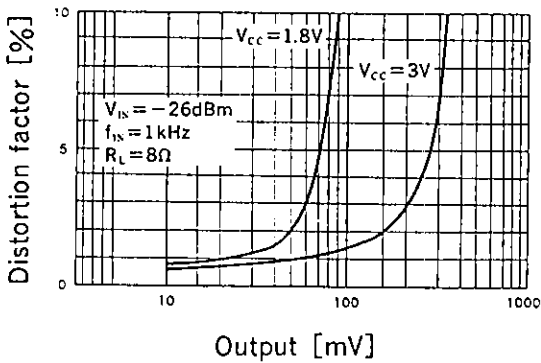

Output vs Distortion factor 4 A1622M BTL mode

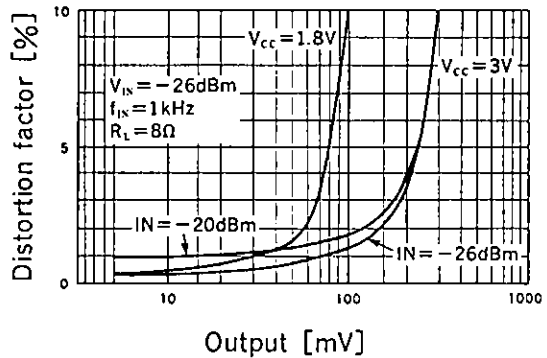

Stereo mode frequency characteristics
 $V_{IN} = -40\text{dBm}$ VOL MAX $V_{CC} = 3\text{V}$

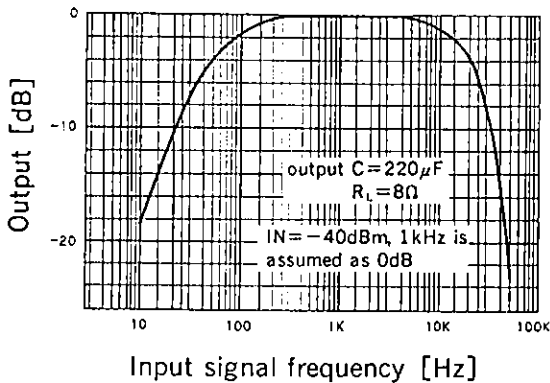

BTL mode frequency characteristics
 $V_{IN} = -40\text{dBm}$ VOL MAX $V_{CC} = 3\text{V}$

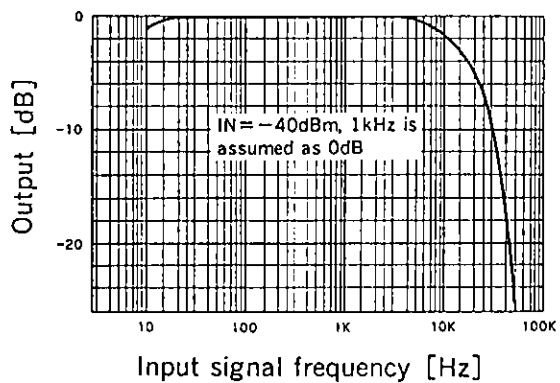

Package Outline Unit: mm

CXA1622P

16 pin DIP (Plastic) 300min 1.0g

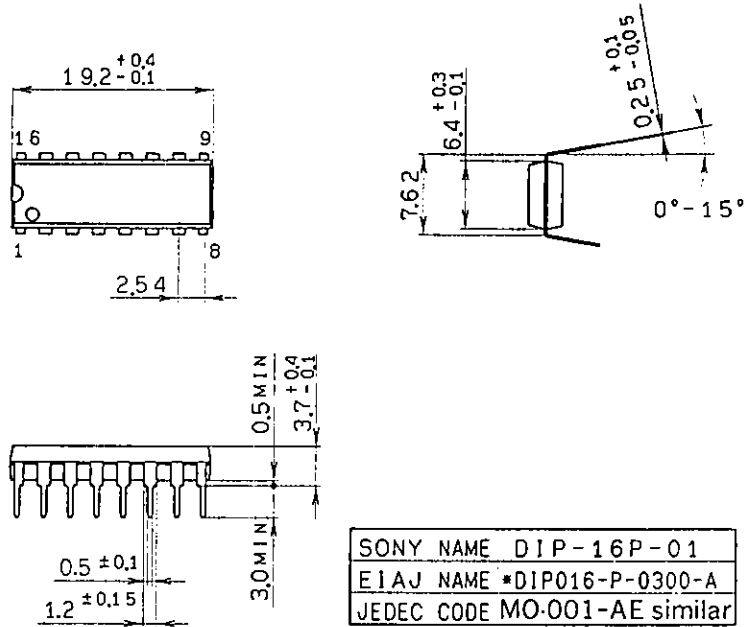

CXA1622M

16 pin SOP (Plastic) 300mil 0.2g

