

High-Frequency SPDT Antenna Switch

Description

The CXG1006N is a high power antenna switch MMIC. This IC is designed using the Sony's GaAs J-FET process and operates at a single positive power supply.

Features

- Single positive power supply operation
- Low insertion loss 0.5dB (Typ.) at 2.0GHz
- High isolation 27dB (Typ.) at 2.0GHz
- High power switching

P1dB (Typ.)	32dBm	at 2.0GHz	$V_{CTL} (H) = 2.0V$
	34dBm	at 2.0GHz	$V_{CTL} (H) = 4.0V$

Application

Antenna switch for digital cellular telephones

Structure

GaAs J-FET MMIC

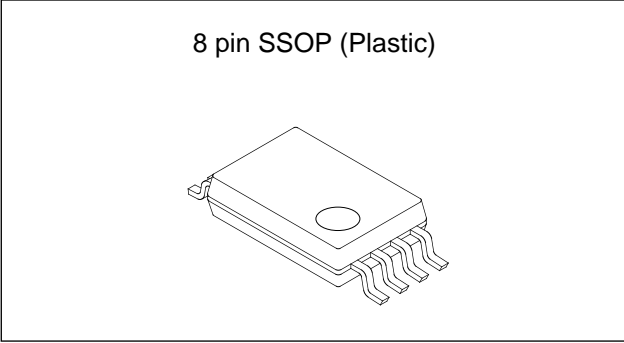

Absolute Maximum Ratings (Ta = 25°C)

- Control voltage V_{ctl} 7 V
- Operating temperature T_{opr} -35 to +85 °C
- Storage temperature T_{stg} -65 to +150 °C

Operating Condition

Control voltage 0/4 V

Sony reserves the right to change products and specifications without prior notice. This information does not convey any license by any implication or otherwise under any patents or other right. Application circuits shown, if any, are typical examples illustrating the operation of the devices. Sony cannot assume responsibility for any problems arising out of the use of these circuits.

Electrical Characteristics

V_{CTL (L)} = 0V, V_{CTL (H)} = 4V, P_{IN} = 30dBm, R_{RF} = 75kΩ (Ta = 25°C)

Item	Symbol	Test Condition	Min.	Typ.	Max.	Unit
Insertion Loss	IL1	f = 1.0GHz		0.3	0.6	dB
Isolation	ISO1		35	40		dB
Insertion Loss	IL1.5	f = 1.5GHz		0.4	0.7	dB
Isolation	ISO1.5		29	32		dB
Insertion Loss	IL2	f = 2.0GHz		0.5	0.8	dB
Isolation	ISO2		24	27		dB
VSWR	VSWR				1.5	
Switching Time	TSW			100		ns

V_{CTL (L)} = 0V, f = 2GHz (Ta = 25°C)

Item	Symbol	Test Condition	Min.	Typ.	Max.	Unit
1dB Compression Point	P1dB (3)	V _{CTL (H)} = 3V	30	32		dBm
1dB Compression Point	P1dB (4)	V _{CTL (H)} = 4V	32	34		dBm

V_{CTL (L)} = 0V, R_{RF} = 75kΩ (Ta = 25°C)

Item	Symbol	Test Condition	Min.	Typ.	Max.	Unit
Control Current	I _{CTL (1)}	V _{CTL (H)} = 3V		100	170	μA
Control Current	I _{CTL (2)}	V _{CTL (H)} = 4V		150	220	μA
Control Current	I _{CTL (3)}	V _{CTL (H)} = 5V		200	270	μA

Block Diagram

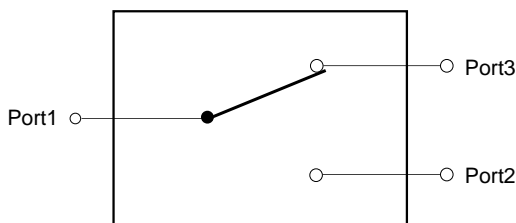

Package Outline/Pin Configuration

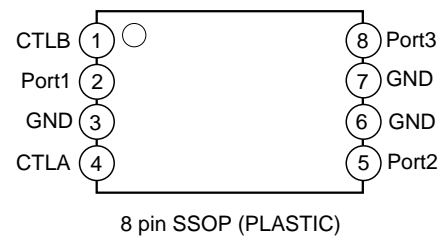

V _{CTLA}	V _{CTLB}	
High	Low	Port1-Port2 ON Port1-Port3 OFF
Low	High	Port1-Port2 OFF Port1-Port3 ON

Recommended Circuit

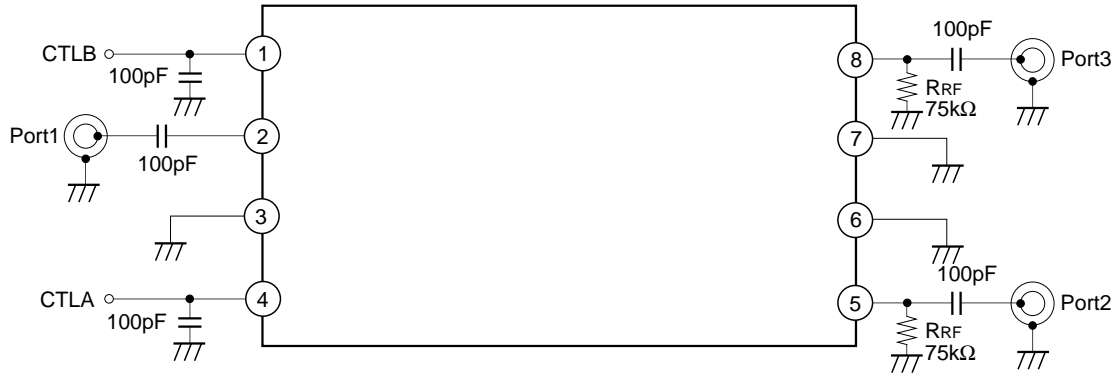

* RRF is used to stabilize the electrical characteristics at high power signal input

Example of Representative Characteristics (Ta = 25°C)

Insertion Loss and Isolation vs. Input Power

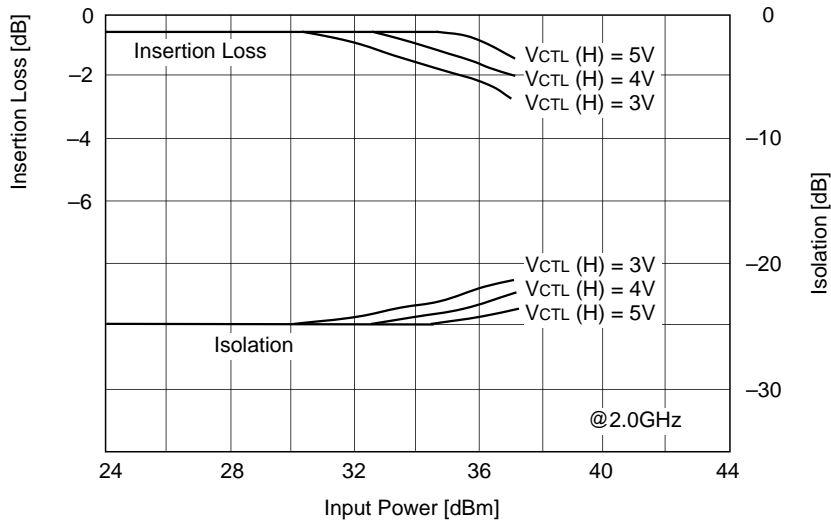

Insertion Loss and Isolation vs. Frequency

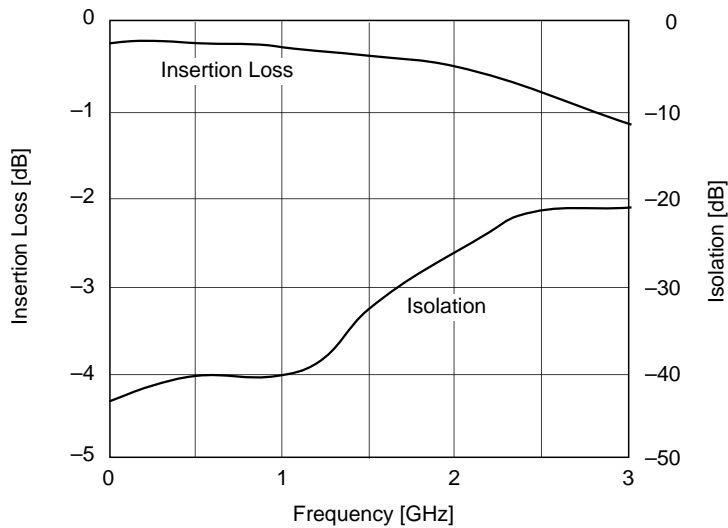

Package Outline

Unit: mm

8PIN SSOP (PLASTIC)

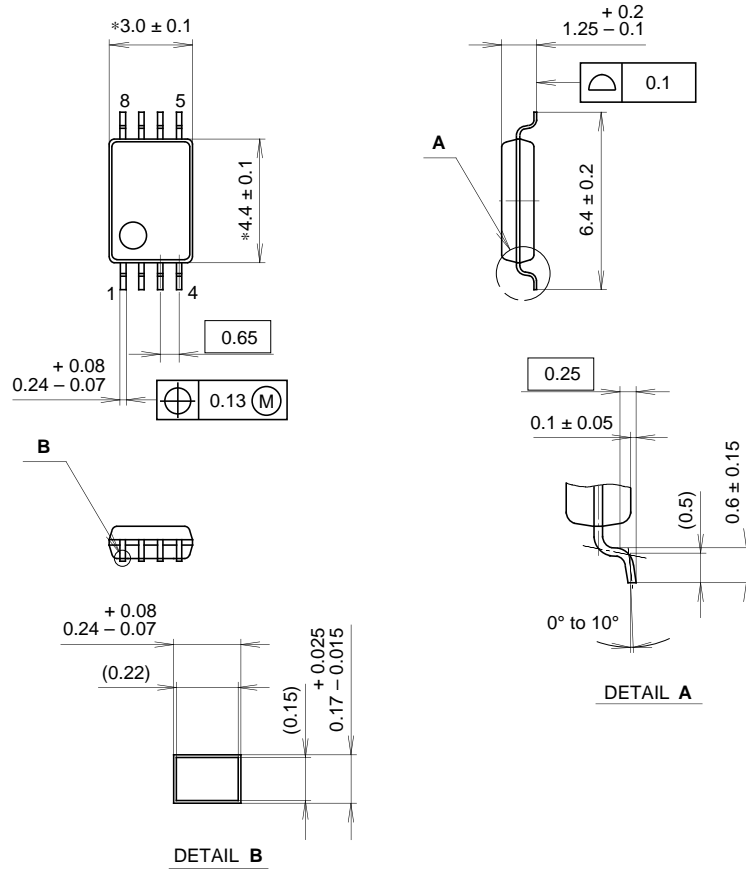

NOTE: Dimension "*" does not include mold protrusion.

PACKAGE STRUCTURE

SONY CODE	SSOP-8P-L01
EIAJ CODE	SSOP008-P-0044
JEDEC CODE	

PACKAGE MATERIAL	EPOXY RESIN
LEAD TREATMENT	SOLDER / PALLADIUM PLATING
LEAD MATERIAL	COPPER ALLOY
PACKAGE WEIGHT	0.04g