

High-Frequency SPDT Antenna Switch

Description

The CXG1024N is a high power antenna switch MMIC to connect Tx/Rx to one of 4 antennas. This IC is designed using the Sony's GaAs J-FET process and operates at a single positive power supply.

Features

- Single positive power supply operation
- Low insertion loss 0.4 dB (Typ.) at 1.0 GHz
 (Tx Port)
- Isolation 21 dB (Typ.) at 1.0 GHz
 (Tx Port)
- High power switching
 P1 dB (Typ.) 32 dBm at 1.5 GHz
 V_{CTL}(H)=3.0 V
 35 dBm at 1.5 GHz
 V_{CTL}(H)=4.0 V

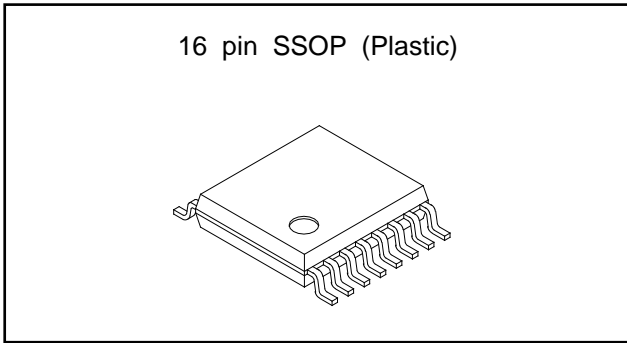

Absolute Maximum Ratings (Ta=25 °C)

- Supply voltage V_{DD} 8 V
- Control voltage V_{ctl} (H)–V_{ctl} (L) 8 V
- Operating temperature T_{opr} –35 to +85 °C
- Storage temperature T_{stg} –65 to +150 °C
- Input Power Pin (RF2, RF3, RF4) 37 dBm
 Pin (RF1, RF5, RF6) 30 dBm

Applications

Antenna switch for digital cellular telephones

Structure

GaAs J-FET MMIC

Function Block Diagram

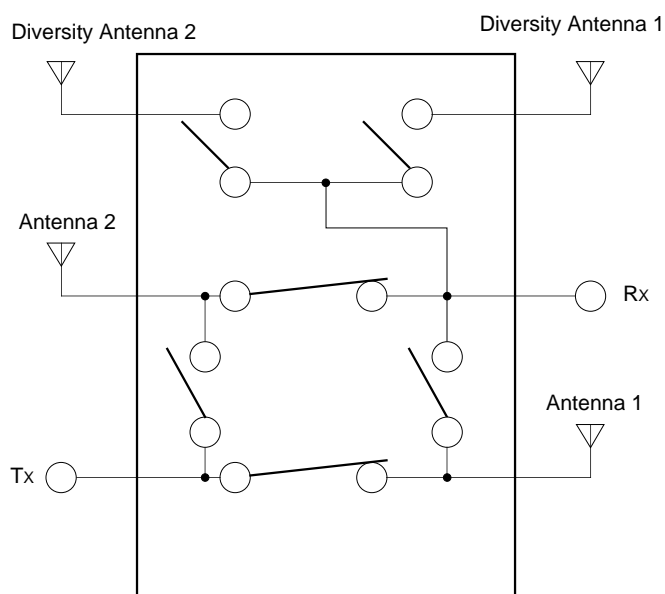

Sony reserves the right to change products and specifications without prior notice. This information does not convey any license by any implication or otherwise under any patents or other right. Application circuits shown, if any, are typical examples illustrating the operation of the devices. Sony cannot assume responsibility for any problems arising out of the use of these circuits.

Pin Configuration and Recommended Circuit

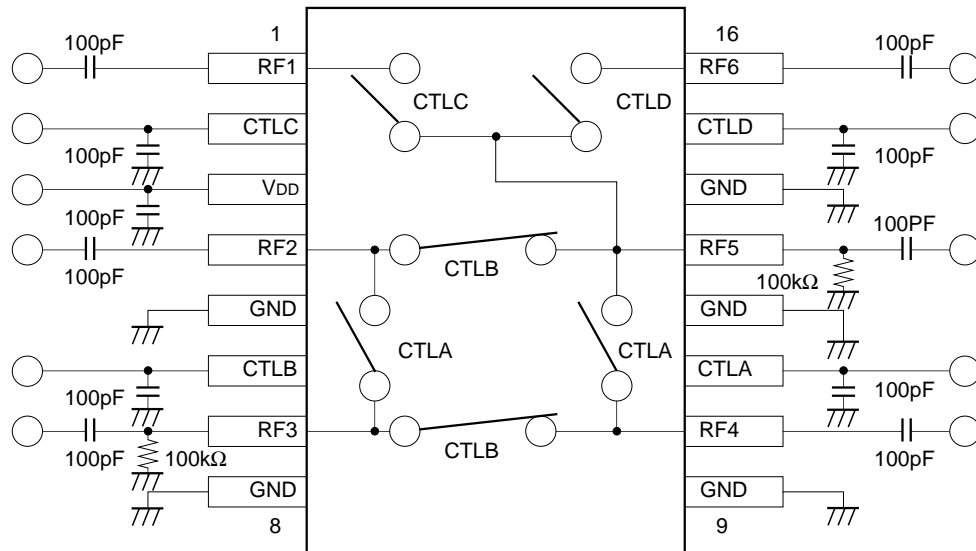

Logic Table

ON-Port	CTLA	CTLB	CTLC	CTLD
RF3–RF2	H	L	H or L	H or L
RF3–RF4	L	H	H or L	H or L
RF5–RF2	L	H	L	L
RF5–RF4	H	L	L	L
RF5–RF6	L	L	L	H
RF5–RF1	L	L	H	L

Recommended Operating Conditions

Item	Symbol	Min.	Typ.	Max.
Control Voltage (high)	Vctl (H)			6
Control Voltage (low)	Vctl (L)	-6		
Difference of Control Voltage	Vctl (H)–Vctl (L)			6
Supply voltage	VDD	Vctl (H)–0.6	Vctl (H)–0.5	Vctl (H)–0.4

Electrical Characteristics

(Ta=25 °C)

	Symbol	Signal Passes	Test Condition	Frequency	Min.	Typ.	Max.	Unit	
Insertion Loss	IL.	RF3–RF2	*2 Pin=30 dBm	1 GHz		0.4	0.65	dB	
		RF3–RF4		1.5 GHz		0.5	0.8		
				2 GHz		0.7	1.0		
		RF5–RF2	*2 Pin=20 dBm	1 GHz		0.5	0.8		
	1.5 GHz			0.65	0.95				
	2 GHz			0.9	1.2				
	RF5–RF4	*2 Pin=20 dBm	1 GHz		0.6	0.9	dB		
	1.5 GHz			0.75	1.05				
	2 GHz			1.2	1.5				
	RF5–RF1 RF5–RF6	*2 Pin=20 dBm	1 GHz		0.4	0.7		dB	
			1.5 GHz		0.5	0.8			
			2 GHz		0.7	1.0			
Isolation	ISO.	RF3–RF2	*2 Pin=30 dBm	1 GHz	18	21			dB
		RF3–RF4		1.5 GHz	15	18			
				2 GHz	12	15			
		RF5–RF1 RF5–RF6	*2 Pin=20 dBm	1 GHz	21	24			
	1.5 GHz	17		20					
	2 GHz	15		18					
VSWR	VS.	RF3–RF2 RF3–RF4	*2 Pin=30 dBm	0.1 to 2 GHz		1.3	1.5	dB	
		RF5–RF2 RF5–RF4 RF5–RF1 RF5–RF6		*2 Pin=20 dBm	0.1 to 2 GHz		1.3		1.5
1 dB Compression Power	P1 dB	RF3–RF2	*3		1.5 GHz	30	32		dBm
		RF3–RF4		*2	1.5 GHz	33	35		
			*1		1.5 GHz	35	37		
		RF5–RF2 RF5–RF4 RF5–RF1 RF5–RF6		*3	1.5 GHz	22	24		
			*2		1.5 GHz	25	27		
					*1	1.5 GHz	27	29	
Switching Time	tsw			0.1 to 2 GHz			200	nsec	
Control Current	Ictl						100	μA	
Supply Current	IDD						100	μA	
			*2						

*1 : Vctl (H)=5 V, Vctl (L)=0 V, VDD=4.5 V

*3 : Vctl (H)=3 V, Vctl (L)=0 V, VDD=2.5 V

*2 : Vctl (H)=4 V, Vctl (L)=0 V, VDD=3.5 V

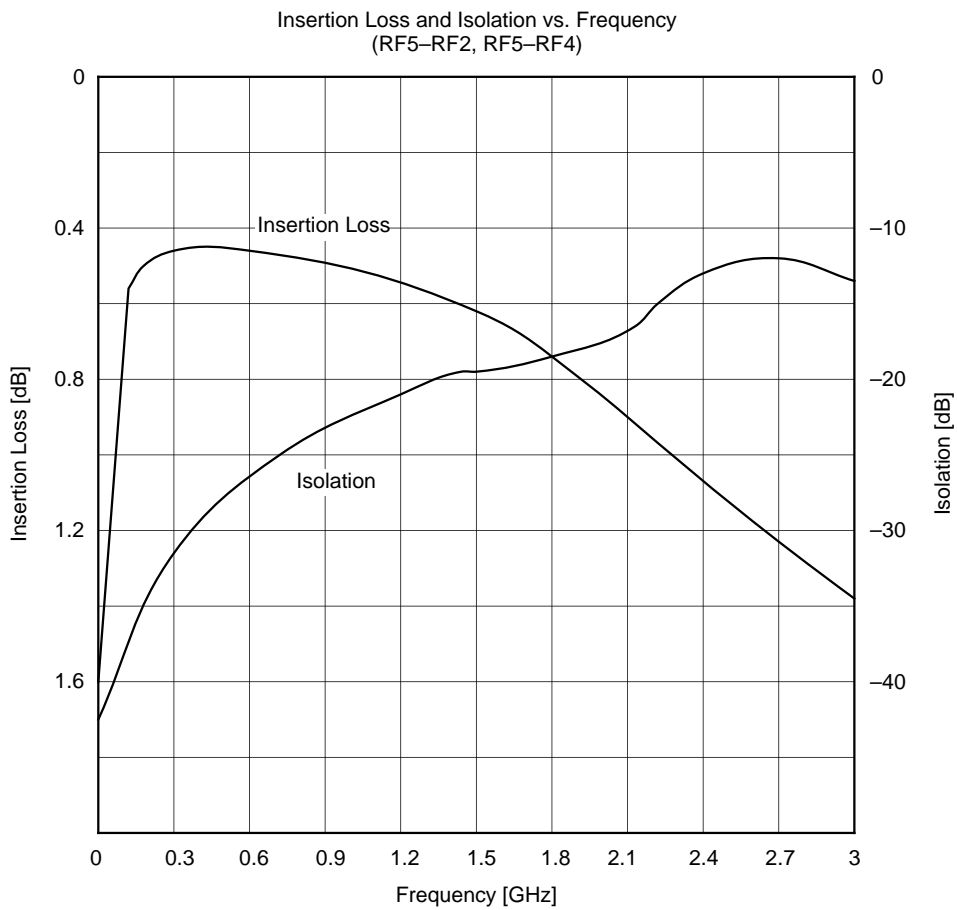
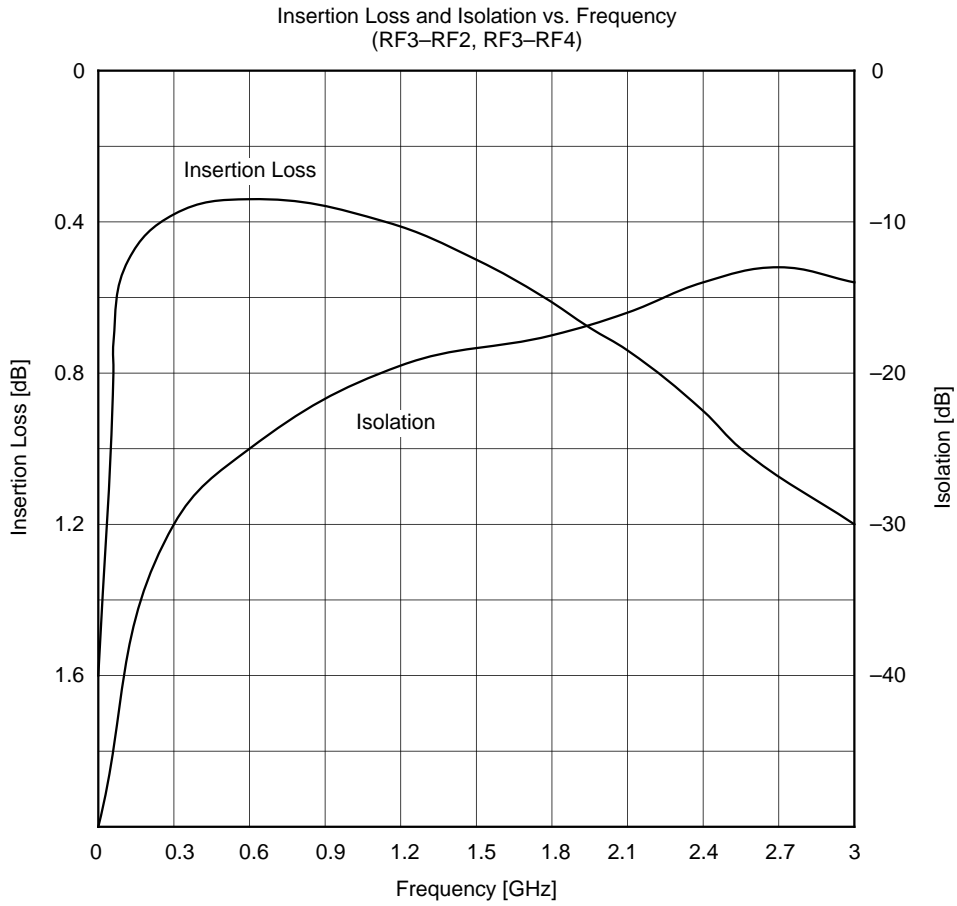

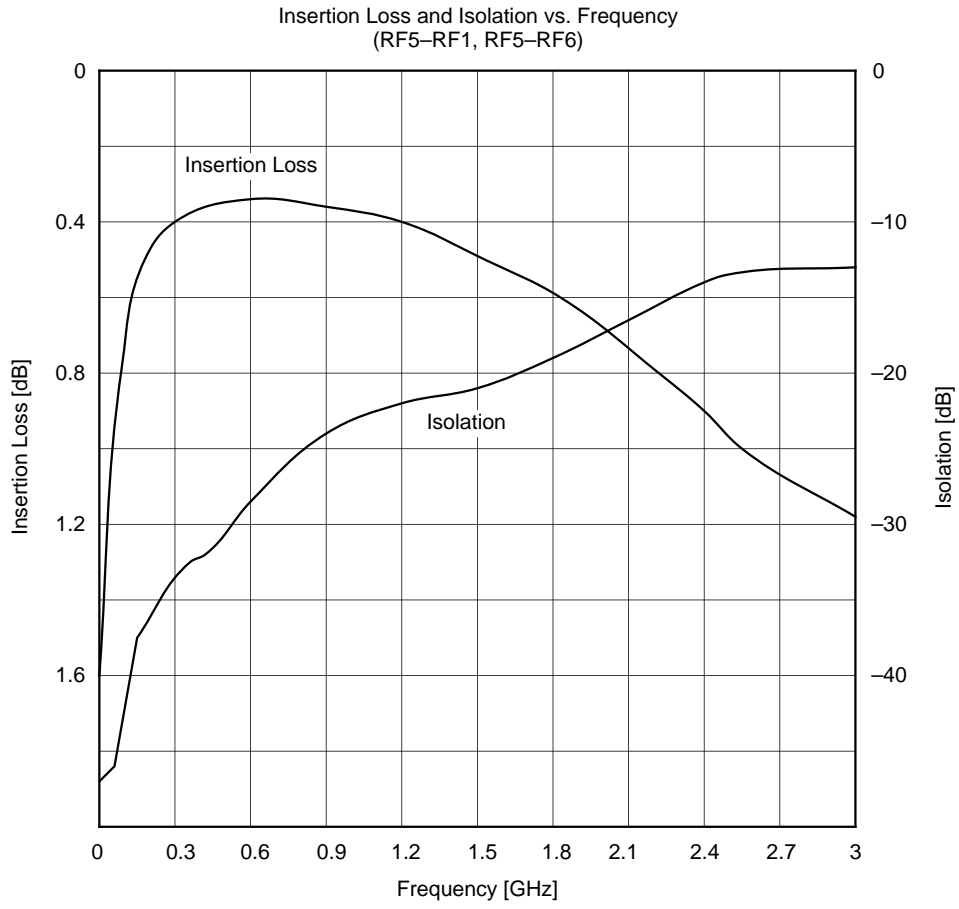

Package Outline Unit : mm

16PIN SSOP (PLASTIC)

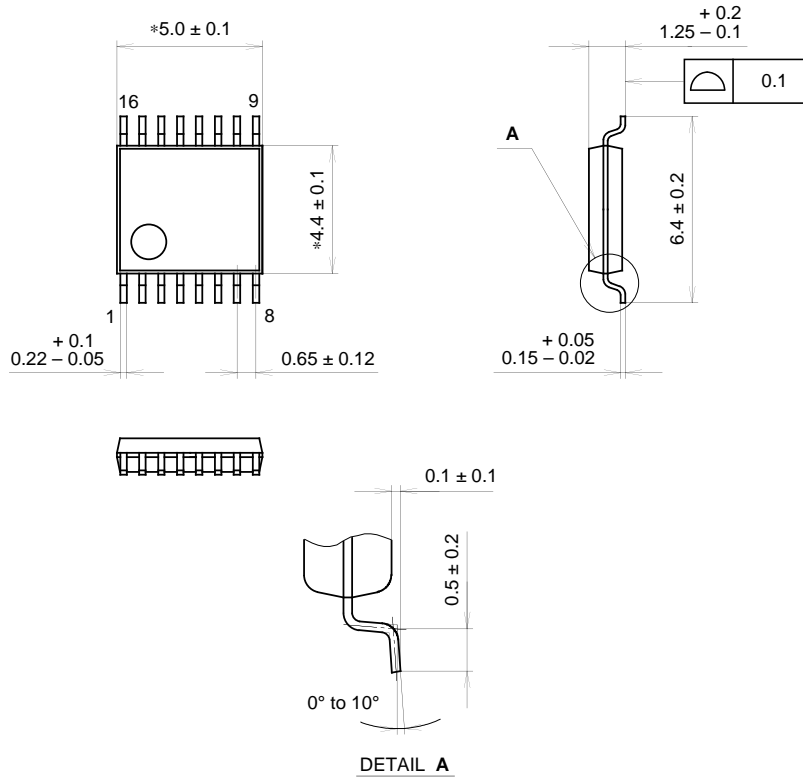

PACKAGE STRUCTURE

SONY CODE	SSOP-16P-L01
EIAJ CODE	SSOP016-P-0044
JEDEC CODE	_____

PACKAGE MATERIAL	EPOXY RESIN
LEAD TREATMENT	SOLDER / PALLADIUM PLATING
LEAD MATERIAL	COPPER / 42 ALLOY
PACKAGE WEIGHT	0.1g