

## System Controller for Compact Disc Players

### Description

The CXP1021Q is a 4-bit single chip microcomputer based on the SPC500 series. It incorporates programs in firmware for CD operations. It can be connected directly to the CDL-40 series of LSIs for CD players, and can directly drive LCDs, in addition to other features. It also supports the pitch control function and can be employed in a wide range of equipment, from deck-type CD players to radio cassettes and portable systems.

80 pin QFP (Plastic)

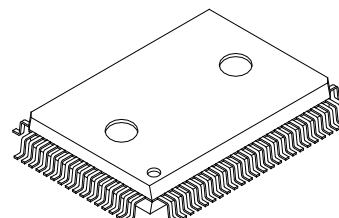

### Functions

- Key inputs of up to 20 keys is possible through matrix scanning. The following functions can be selected by setting their respective keys.
- ▶, ||, ▶|| PLAY/PAUSE/PLAY PAUSE keys
- ■ STOP key
- ◀◀, ▶▶ SKIP key; on memory input, this becomes the tune selection key
- ◀◀, ▶▶ Fast forward key; speed differs during PLAY and PAUSE
- Repeat One tune or all tunes repeat
- OPEN/CLOSE Loading function (when deck type device is selected)
- A ↔ B A ↔ B repeat function
- SHUFFLE Shuffle (random) function
- PROG Program; up to 21 tune memory, can indicate remainder
- REMAIN Indicates single tune or all tunes remaining, up to 31 tunes
- INTRO Fixes introscan at 10 seconds
- AUTO Sets auto space at 4 seconds
- MUSIC calendar Can display up to 20 tunes
- REMOTE Enables input using NEC format remote control devices with modifiable custom codes
- 10key Direct tune selection using keypad (remote control only)
- Syncro Synchronization input and processing
- × 2 Double speed playback
- Battery detection When portable mode selected, there is battery detection function
- Built-in test mode Built-in test mode facilitates CD player auto diagnostics
- INDEX → ← Index search (remote control only)
- Pitch +, pitch -, pitch OFF Pitch control key for playback with varying speed
- External control output Used for on/off of the voice canceller

### Recommended Combinations

- RF amplifier CXA1571M/N/S
- Servo signal processor CXA1372AQ/AS
- Digital signal processor CXD2500BQ
- Pickup mechanism KSL 2101

### Structure

Silicon gate CMOS IC

Sony reserves the right to change products and specifications without prior notice. This information does not convey any license by any implication or otherwise under any patents or other right. Application circuits shown, if any, are typical examples illustrating the operation of the devices. Sony cannot assume responsibility for any problems arising out of the use of these circuits.

## Features

- Can be connected directly to CDL-40 series LSIs for CD use
- Up to 20 keys can be connected directly; expansion of functions through addition of keys is possible

## Types of Keys

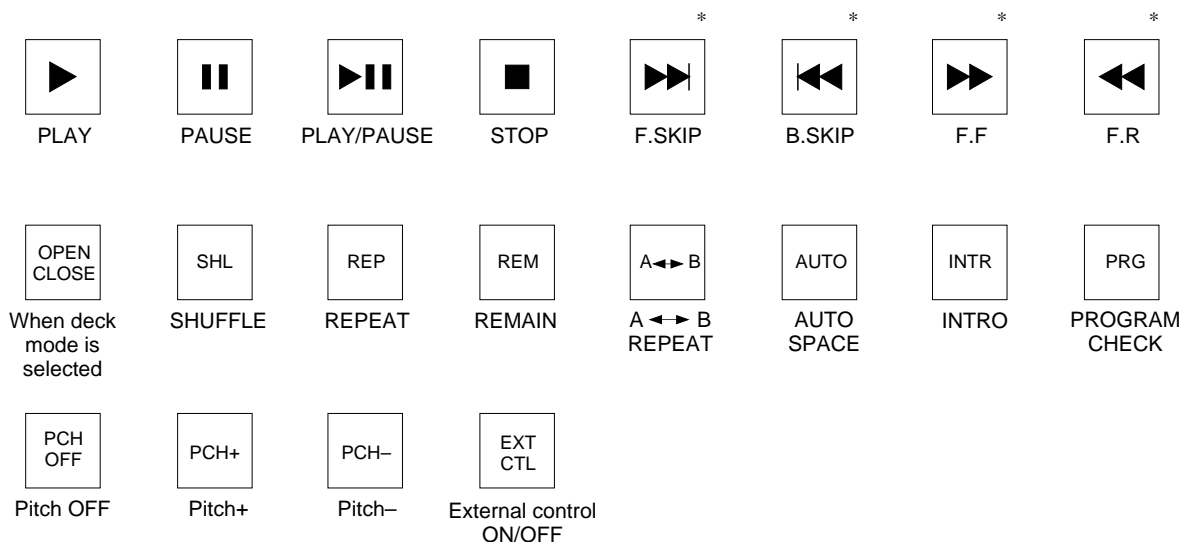

\* Multiple functions can be combined.

- LCDs can be driven directly. This includes time display, music calendar, remaining tunes and other display functions.
- NEC format remote control input possible; index search, direct tune selection through keypad and other functions can be added.
- Supports auxiliary functions including synchronization input, double-speed output and pitch control.
- Easy switching between deck and portable equipment using external pins.
  - With deck type selected, performs tray loading function.
  - With portable type selected, displays detection of weak battery and executes emergency termination when battery voltage is low.
 In this way, it functions specific to the system required.
- A built-in test mode facilitates adjustment of the CD player and can be used for tests and evaluations.



Pin Configuration

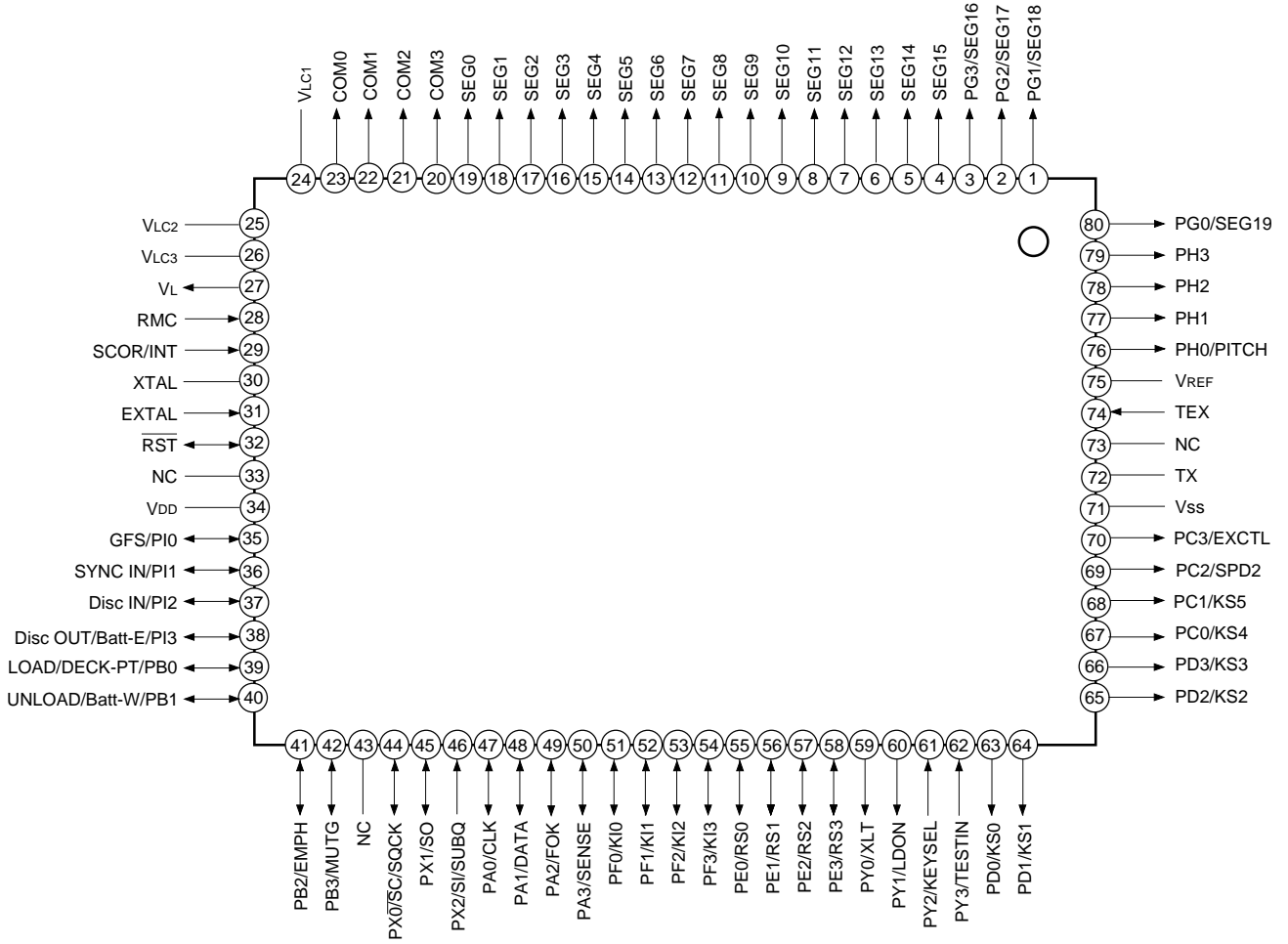

## Pin Description

Pin No.	Symbol	Function code	I/O	Description
1	PG1/SEG18	SEG18	O	Connect to LCD (refer to LCD example).
2	PG2/SEG17	SEG17		
3	PG3/SEG16	SEG16		
4	SEG15	SEG15		
5	SEG14	SEG14		
6	SEG13	SEG13		
7	SEG12	SEG12		
8	SEG11	SEG11		
9	SEG10	SEG10		
10	SEG9	SEG9		
11	SEG8	SEG8		
12	SEG7	SEG7		
13	SEG6	SEG6		
14	SEG5	SEG5		
15	SEG4	SEG4		
16	SEG3	SEG3		
17	SEG2	SEG2		
18	SEG1	SEG1		
19	SEG0	SEG0		
20	COM3	COM3		
21	COM2	COM2		
22	COM1	COM1		
23	COM0	COM0		
24	V <sub>L</sub>		O	LCD bias power supply.
25	V <sub>LC1</sub>			LCD bias power supply.
26	V <sub>LC2</sub>			
27	V <sub>LC3</sub>			
28	RMC	RMC	I	Connect to remote control input and remote control module.
29	INT	SCOR	I	SCOR input; connect to CXD2500 SCOR (63).
30	XTAL			Connected between XTAL and EXTAL when X'TAL is used.
31	EXTAL		I	Connect clock (4.19MHz).
32	RST	RST	I/O	Connect reset.
33	NC			No connected.
34	V <sub>DD</sub>			V <sub>DD</sub>

Pin No.	Symbol	Function code	I/O	Description
35	PI0/AD0	GFS	I	Monitors disc state; connect to CXD2500BQ GFS (42).
36	PI1/AD1	SYNCIN	I	Used to start the CD synchronously with external equipment (cassette deck, ect.). Starts at falling edge ( $\downarrow$ ).
37	PI2/AD2	DISCIN	I	Switch to "L" when tray enters a unit in deck mode, or when lid is closed in portable mode.
38	PI3/AD3	DISCOUT/ BATT-E	I	Switch to "L" when tray is open in deck mode, and when there are no batteries in portable mode.
39	PB0/AD4	LOAD/ DECK · PT	I/O	In deck mode, indicates tray loading motor operation; on "L" detection immediately after reset, performs portable mode branching.
40	PB1/AD5	UNLOAD/ BATT-W	I/O	In deck mode, output to tray loading motor; in portable mode, output to battery warning display.
41	PB2/AD6	EMPH	O	Emphasis output signal.
42	PB3/AD7	MUTG	O	Turns mute on when mute signal is "H".
43	NC			No connected.
44	PX0/SC	SQCK	O	SUB-Q reading clock output
45	PX1/SO		O	No connected.
46	PX2/SI	SUBQ	I	SUB-Q code input port.
47	PA0	CLK	O	8-bit data clock output.
48	PA1	DATA	O	8-bit data output.
49	PA2	FOK	I	Inputs focus state; connect to CXA1372AQ FOK (33).
50	PA3	SENSE	I	SENSE input (monitor for different systems)
51	PF0	KI0	I	Key scan input port; reads the remote control customer code on reset or startup.
52	PF1	KI1		
53	PF2	KI2		
54	PF3	KI3		
55	PE0	RS0	O	RMC customer code scan signal.
56	PE1	RS1		
57	PE2	RS2		
58	PE3	RS3		
59	PY0	XLT	O	Latch output.
60	PY1/PWM	LDON	O	Laser diode control; "L": on, "H": off
61	PY2/WP	KEYSEL	I	Key combining switch input.
62	PY3/EC	TESTIN	I	Performs test mode branching on detection of "L" immediately after reset.

Pin No.	Symbol	Function code	I/O	Description
63	PD0	KS0	O	Key scan output signal.
64	PD1	KS1		
65	PD2	KS2		
66	PD3	KS3		
67	PC0	KS4		
68	PC1	KS5		
69	PC2	SPD2	O	Double speed output; "L" for double speed playback.
70	PC3	EXTCTL	O	External control.
71	V <sub>SS</sub>			Connect to GND.
72	TX			No connected.
73	NC			No connected.
74	TEX			Connect to GND.
75	V <sub>REF</sub>			V <sub>DD</sub>
76	PH0	PITCH	O	Pitch control display output.
77	PH1		O	Unused.
78	PH2		O	Unused.
79	PH3		O	Unused.
80	PG0/SEG19	SEG19	O	Connect to LCD (refer to LCD example).

LCD Example

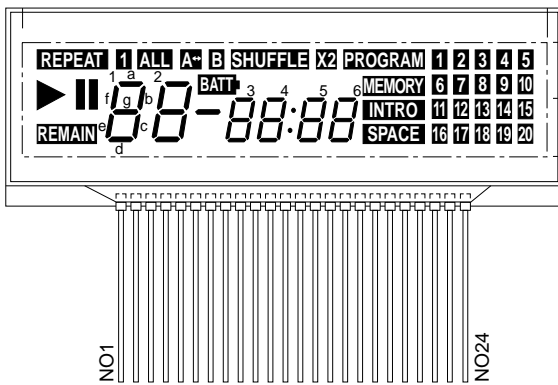
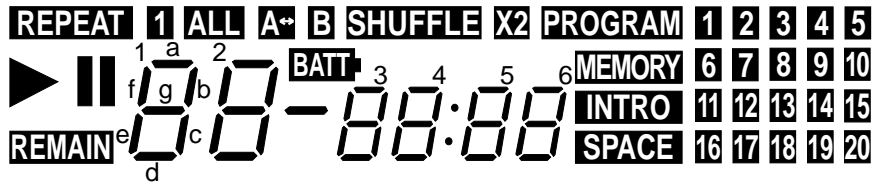

No.	COM. 3	COM. 2	COM. 1	COM. 0	Function code
1				COM. 0	COM0
2			COM. 1		COM1
3		COM. 2			COM2
4	COM. 3				COM3
5	REMAIN		▶	REPEAT	SEG0
6	1d	1e	1f	1 (Left)	SEG1
7	1c	1g	1b	1a	SEG2
8	2d	2e	2f	ALL	SEG3
9	2c	2g	2b	2a	SEG4
10		—	B	A ↔	SEG5
11	3d	3e	3f	BATT	SEG6
12	3c	3g	3b	3a	SEG7
13	4d	4e	4f	SHUFFLE	SEG8
14	4c	4g	4b	4a	SEG9
15	5d	5e	5f	:	SEG10
16	5c	5g	5b	5a	SEG11
17	6d	6e	6f	× 2	SEG12
18	6c	6g	6b	6a	SEG13
19	SPACE	INTRO	MEMORY	PROGRAM	SEG14
20	16	11	6	1 (Right)	SEG15
21	17	12	7	2	SEG16
22	18	13	8	3	SEG17
23	19	14	9	4	SEG18
24	20	15	10	5	SEG19

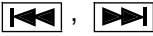
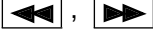
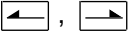

## List of Functions

1. TEST MODE For adjustment of the CD player.
2. Deck/Portable select Switches between deck mode and portable mode. In deck mode the tray loading function is activated; in portable mode, the battery detection function is activated.
3. Remote control input Accepts signals from a NEC format remote control unit. A 16-bit custom code can be selected.
4.  Keys to initiate playing can be selected.
5.  Performs tune selection.
6.  Performs fast-forward and rewind. The speed differs during Play and Pause.
7. Remain Can display Single Remain, All Remain, Program Remain.
8. Repeat For repetition of one or of all tunes.
9. A ↔ B For performance of A ↔ B repeat.
10. Shuffle Performed shuffled (random) playing.
11. AUTO Inserts 4-second blanks between tunes.
12. INTRO Plays the initial 10 seconds of a disc.
13. PROG Enables programming of up to 21 tunes.
14. 1 to 10, +10 Enables direct tune selection using the keypad (for use with a remote control unit only).
15. Battery input A function for detection of reduced battery voltage is provided by the Batt-W and Batt-E pins (portable mode only).
16. Sync rate input For sync rate input and activation.
17. Double-speed playback Double-speed playback is possible by attaching an external circuit.
18. Loading function With the deck mode selected, tray loading is possible.
19. Key combining function The tune select and fast-forward keys can be combined or kept independent, and the repeat key and mode key can be selected.
20.  Performs index search (for use with a remote control unit only).
21. PCH+, PCH-, PCH OFF Accelerates/decelerates the pitch (playing speed) to vary the internal.

**1. Deck mode/portable mode selection**

A feature of the CXP1021Q is its ability to be used in both deck-type and in portable equipment.

(a) Selection

Selection is executed through Pin 39 (LOAD/DECK-PT). Mode selection is determined by the condition of this pin immediately after reset of the CXP1021Q.

When Pin 39 (LOAD/DECK-PT) is high: Deck mode

When Pin 39 (LOAD/DECK-PT) is low: Portable/radio cassette mode

(b) Deck mode

- In deck mode the tray loading function is activated.
- Pins necessary for tray operation:

For the loading motor	For the tray SW
Pin 40 (UNLOAD/Batt-W) goes "L" when tray is ejected	Pin 37 (Disc IN) goes "L" when the tray is closed
Pin 39 (LOAD/DECK PT) goes "L" when tray is closed	Pin 38 (Disc OUT/Batt-E) goes "L" when tray is fully opened

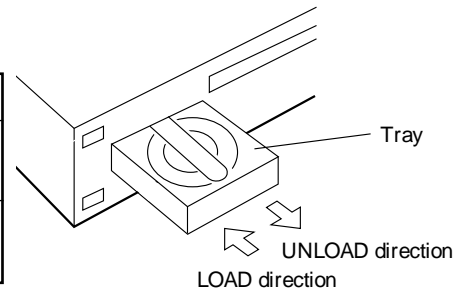

- The relation between Pin 40 (UNLOAD/Batt-W) and Pin 39 (LOAD/DECK-PT) is as follows.

State	Pin 40/UNLOAD	Pin 39/LOAD
Open (stopped)	H	H
LOAD direction	H	L
UNLOAD direction	L	H

(c) Portable mode

- In portable mode, when the lid is closed the operation changes to TOC reading.
- Pin 39 (LOAD/DECK-PT) should be held "L".
- Pin 37 (Disc IN) should be connected to a switch that makes the pin go "L" when the lid is closed.
- Two pins used in deck mode can be employed to detect a reduced battery voltage.
- When Pin 40 (UNLOAD/Batt-W) is made "L" through the reduced voltage detection circuit, BATT is displayed.
- In addition, when Pin 40 (UNLOAD/Batt-W) is "L", forcing Pin 38 (Disc OUT/Batt-E) "L" induces the STOP state.

**2. Key combination selection**

This function can be used to reduce the number of keys needed.

(a) Selection

Selection is made through Pin 61 (KEYSEL). Selection is determined by the state of this pin immediately after reset of the CXP1021Q.

When Pin 61 (KEYSEL) is high: **⏮ / ⏪**, **⏩ / ⏭** keys are combined.

When Pin 61 (KEYSEL) is low: **⏮ / ⏪**, **⏩ / ⏭** keys are independent.

(b) Operation when Pin 18 (KEYSEL) is high

Key name	Description
<p><b>⏮, ⏩</b></p>	<p>Function differs depending on length of time pressed.                      If the length of time pressed is:                      0.5 seconds or less ..... keys function as tune select keys ( <b>⏮, ⏩</b> )                      longer than 0.5 seconds ... keys function as fast-forward, rewind keys ( <b>⏪, ⏭</b> )</p>

3. Remote control

Any NEC format remote control can be used. Please note that no other remote control units are supported.

(a) Format

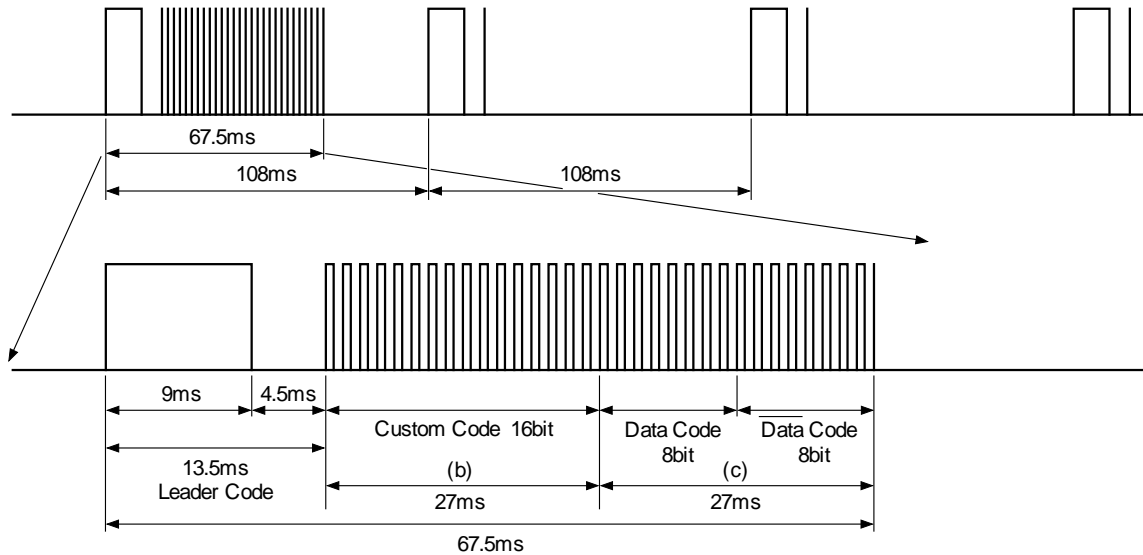

(b) Custom code setting

16 bits of the custom code can be set.

(c) Remote control data

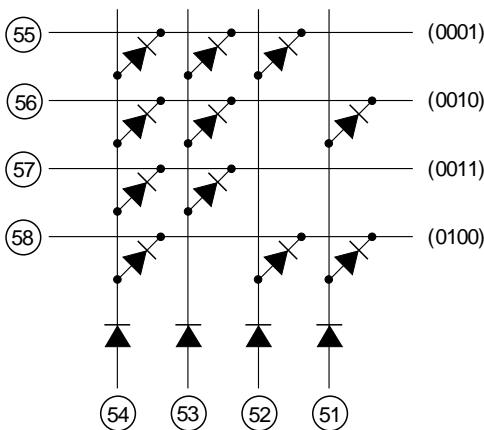

(Example: custom code "1234")

By forming a diode matrix, a single bit of data is created; adding a diode at each point sets that point to "0". Please use the above example as a reference.

This matrix is read only immediately after the power is turned on.

Code D7 ——— D0	Contents	Code D7 ——— D0	Contents
0 0 0 0 0 0 0 0	SHUFFLE	0 0 0 1 0 0 0 0	OPEN
0 0 0 0 0 0 0 1	Repeat	0 0 0 1 0 0 0 1	7
0 0 0 0 0 0 1 0	Remain	0 0 0 1 0 0 1 0	10
0 0 0 0 0 0 1 1	PROGRAM	0 0 0 1 0 0 1 1	▶
0 0 0 0 0 1 0 0	INTRO	0 0 0 1 0 1 0 0	▶▶
0 0 0 0 0 1 0 1	AUTO SPACE	0 0 0 1 0 1 0 1	8
0 0 0 0 0 1 1 0	A ↔ B	0 0 0 1 0 1 1 0	+10
0 0 0 0 0 1 1 1	—	0 0 0 1 0 1 1 1	9
0 0 0 0 1 0 0 0	—	0 0 0 1 1 0 0 0	—
0 0 0 0 1 0 0 1	1	0 0 0 1 1 0 0 1	5
0 0 0 0 1 0 1 0	◀◀	0 0 0 1 1 0 1 0	◀▶
0 0 0 0 1 0 1 1		0 0 0 1 1 0 1 1	6
0 0 0 0 1 1 0 0	◀	0 0 0 1 1 1 0 0	→
0 0 0 0 1 1 0 1	4	0 0 0 1 1 1 0 1	2
0 0 0 0 1 1 1 0	◀◀	0 0 0 1 1 1 1 0	▶▶
0 0 0 0 1 1 1 1	■	0 0 0 1 1 1 1 1	3

The data on the receiving end is as shown above and cannot be changed.

For the transmitting end, please refer to the specifications of the transmitting side chip.

4. To play in deck mode

(a) Turn the power on.

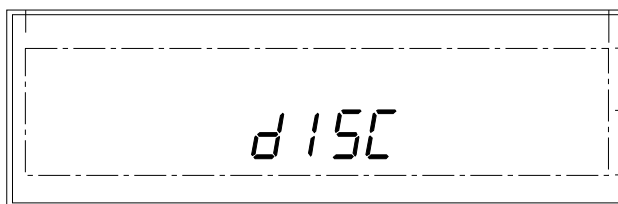
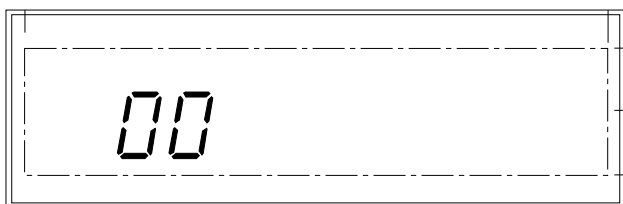

- If the tray is in the open state, a disc can be loaded.
- A focus search is performed, and if a disc is already loaded, the TOC is read.
- If a disc is not loaded, "disc" is displayed.

(b) When the TOC has been read

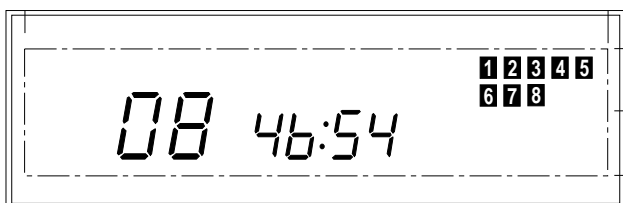

(c) To load a disc

- Press **OPEN**



(d) To play the disc

- Press **▶** or **▶||**.

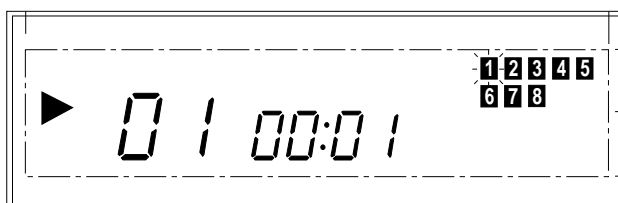

(e) To pause during playing

- Press **||** or **▶||**.

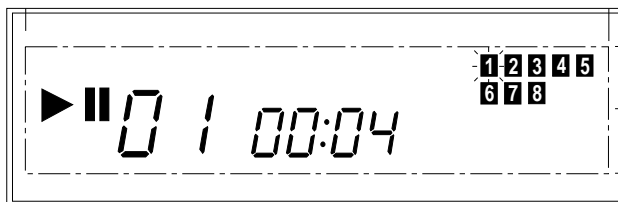

(f) To stop playing

- Press **■**

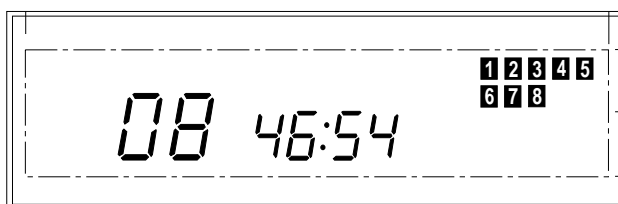

5. To play in portable mode

(a) Turn the power on.

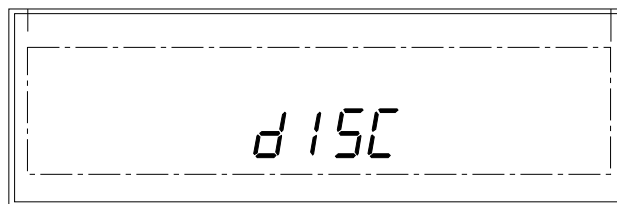
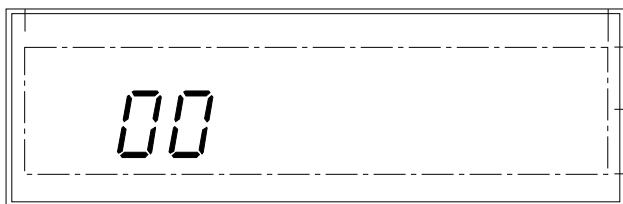

- When the lid is open, no operation takes place.
- A focus search is performed, and if a disc is already loaded, the TOC is read.
- When no disc is loaded, "disc" is displayed.

(b) When the TOC has been read

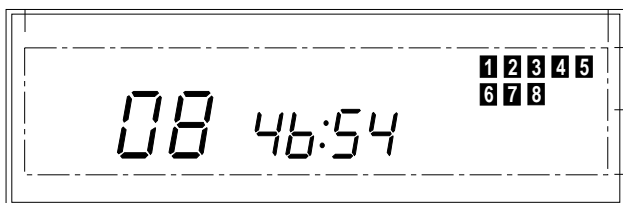

(c) To load a disc

- Open the lid.



(d) To play the disc

- Press  or .

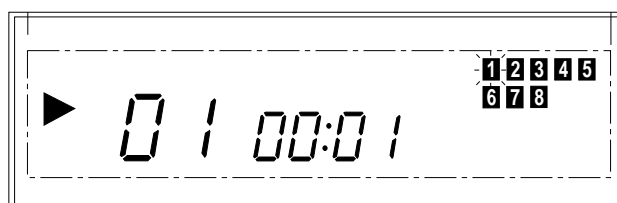

(e) To pause during playing

- Press  or .

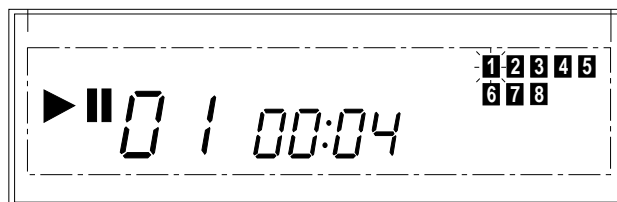

(f) To stop playing

- Press .

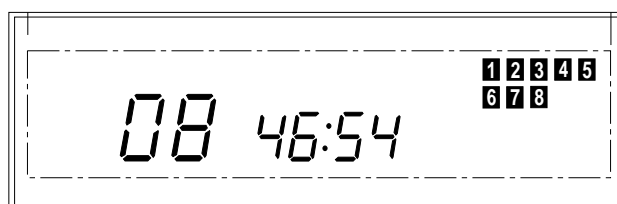

Functions common to the deck mode and the portable/radio cassette mode.

6. To begin listening from a specific tune

- Press or .  
(Example: Sixth tune specified)
- If the keys are pressed continuously, the tune number continues to change.
- After a few seconds playing starts.

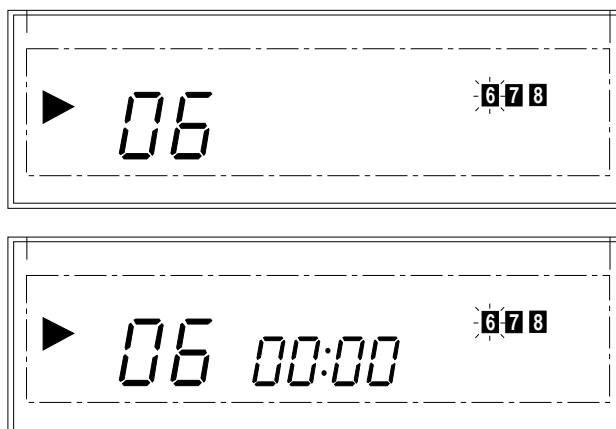

→ tune can be specified directly only by remote control.

Tunes **1** to **10** can be specified directly using the corresponding keys. For tunes following tune 10, the following procedure is used.

- Press **+10** .
- Following this, press a key from **1** to **10**.
- If there are not more than 10 tunes on the disc, the **+10** key is invalid.

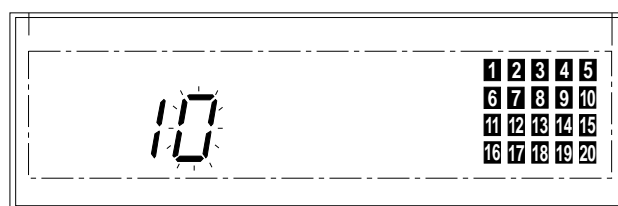

7. To move to a desired place on the disc

- During play, press or .
- The player moves at high speed, emitting a small sound during play, or without emitting a sound during pause.

8. To check the time remaining on the disc

- Press **Remain** .
- When pressed once, the time remaining for the tune currently being played is displayed. When the tune being played is beyond the 32nd tune, " " is displayed.
- Pressing **Remain** once again causes the time remaining on the disc to be displayed.
- Pressing **Remain** once again restores the normal display.

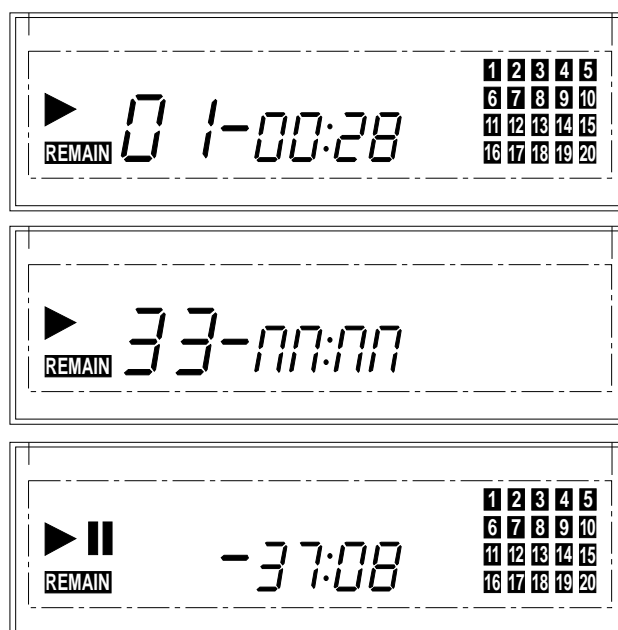

**9. To repeat a tune or tunes**

- Press **Repeat**.
- Pressing once causes one tune to be repeated.
- Pressing once more causes all tunes to be repeated. In program playback mode, all the programmed tunes to be repeated.
- Pressing once more turns off Repeat mode.

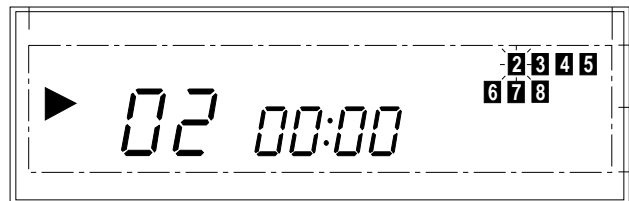
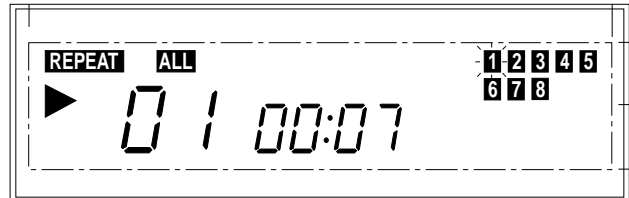

**10. A ↔ B repeat function**

Used to repeatedly play the part of the disc from a certain point A to a certain point B.

- At the starting point of the interval A↔B, press **A↔B**.
- At the ending point of the interval A↔B, once again press **A↔B**. On doing so, the interval A↔B will be played repeatedly.
- To stop repeated A↔B play, press **A↔B** once again, or press **Repeat**.

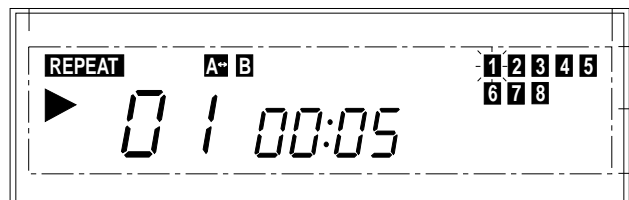

**11. To play tunes out of order (Shuffle)**

- Press **SHUFFLE**.
- Press **▶** or **▶||**.
- Play starts.
- If **SHUFFLE** is pressed during play, shuffled play starts from the end of the current tune.

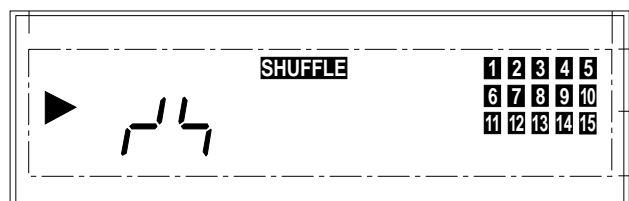
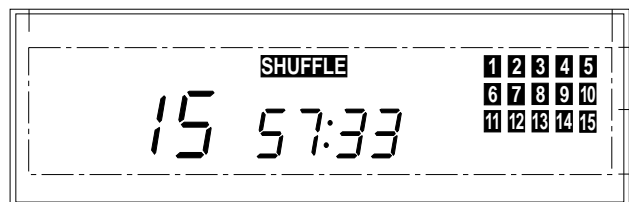



**12. To insert a 4-second blank between tunes**

When dubbing onto tapes or in similar situations, it is sometimes necessary to insert blanks between tunes.

- Press **AUTO**.
- Pressing **AUTO** once more cancels the function.

**Note)** When playing the introduction and when **▶▶** is pressed, blank is not inserted.

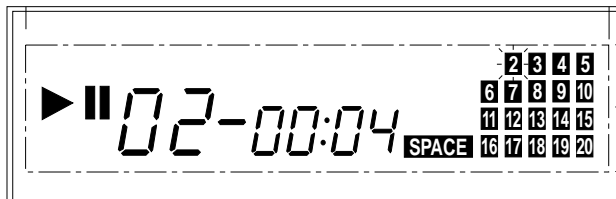

**13. To listen to the disc introduction only for 10 seconds**

- Press **INTRO**.
- Pressing **INTRO** once more cancels the function.
- It is possible to play the introduction during Shuffle and Program operation also.
- In Repeat All mode, introduction play does not halt even when the last tune is reached, but is repeated.

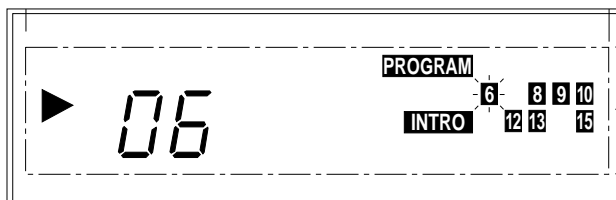
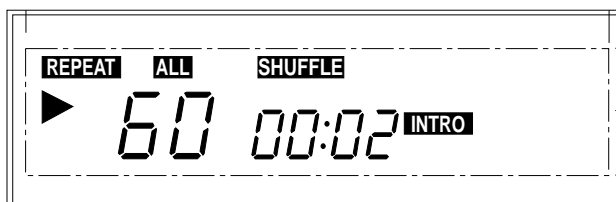
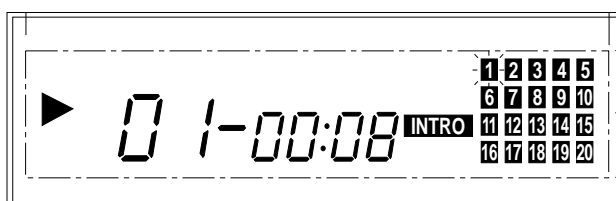

14. Program play

Up to 21 tunes can be programmed for listening and played.

(a) Press **PROG**.

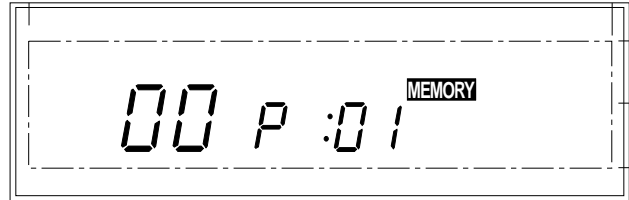

(b) Select a tune number using the **◀◀** and **▶▶** keys.

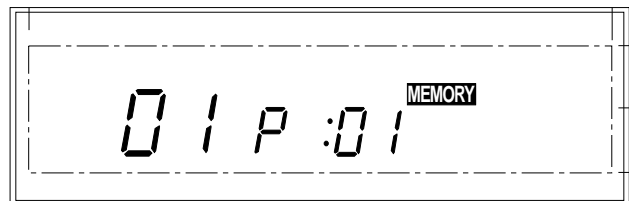

(c) Press **PROG**.  
Repeat steps (b) and (c) for all the tunes desired.

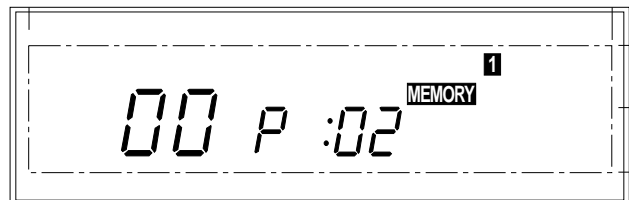

(d) Pressing **■** or entering 00 restores the initial setting.

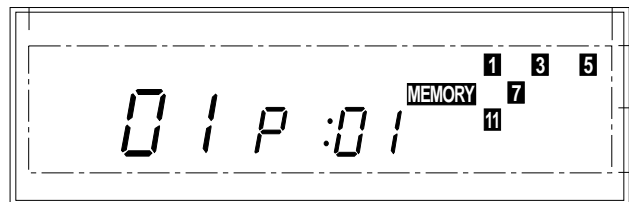

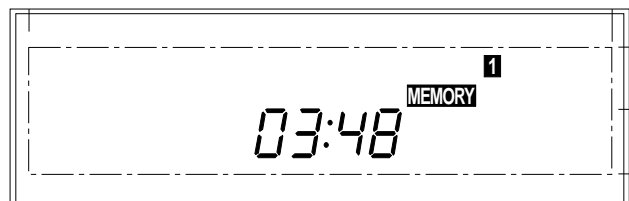

(e) When **Remain** is pressed while in state (b), the total remaining time is displayed while the key is pressed. By using the **◀◀** and **▶▶** keys with the **Remain** key, the total play time can be checked while programming.

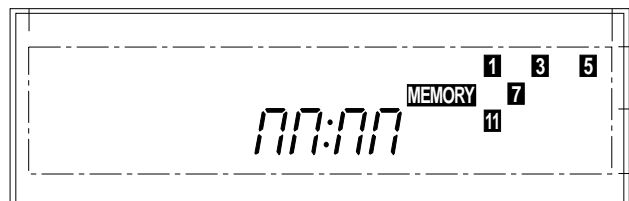

(f) If, among the tunes included in programming, any one or more tunes is numbered above 32, the display shown on the right appears.



(g) Pressing  or  begins play.

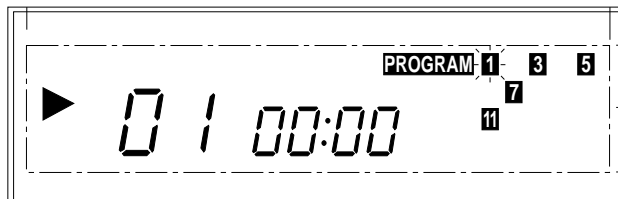

(h) The music calendar of a tune disappears as the tune is completed.

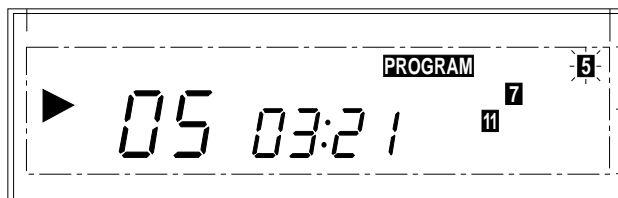

(i) In the above state, pressing the **Remain** key causes the remaining time of the tune being played to display.

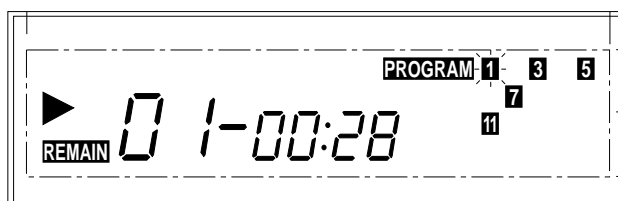

(j) If the tune being played is numbered above 32, the display shown on the right appears.

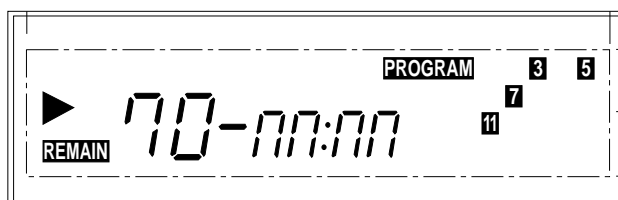

(k) During display of the remaining time of the current tune, if the **Remain** key is pressed once more the remaining time for all the programmed tunes is displayed.

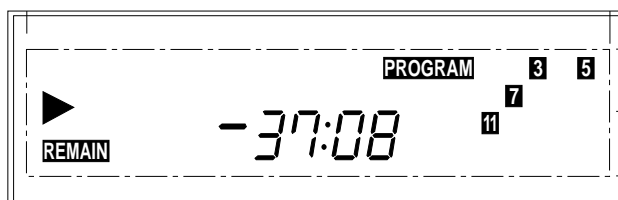

(l) If any of the tunes remaining to be played is numbered above 32, the display shown on the right appears.

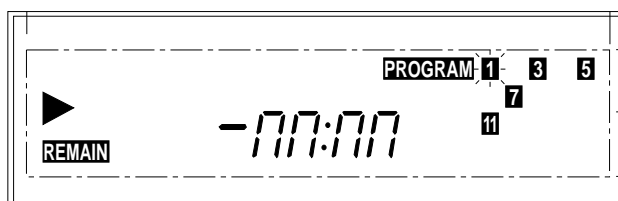

(m) To stop playing press .

To play the previous program again, press **PROG** once more and set Memory mode. The contents of the previous program are stored and can be used again.

When the tray or lid is opened, the program contents are cleared.

**15. Battery input (in portable mode)**

Using pins: Pin 40 (UNLOAD/Batt-W)  
Pin 38 (Disc OUT/Batt-E)

- (a) When Batt-W is "L", the BATT lamp lights.
- (b) When both Batt-W and Batt-E are "L", the unit is forced to stop, "disc" is displayed, and keys no longer function.

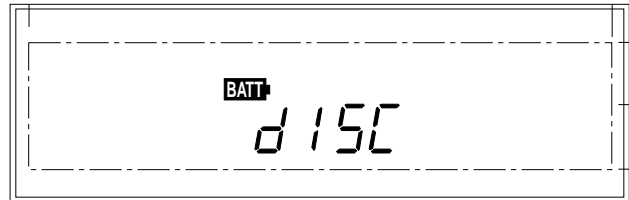
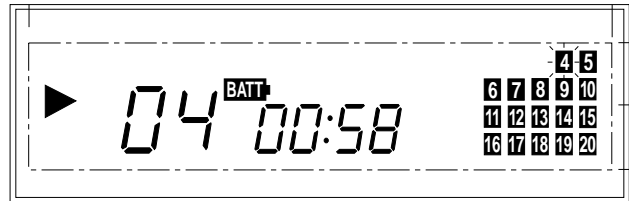

**16. Sync rate function**

This function is used to play the CD player in synchronization with the record key of a cassette deck.

Operation is triggered by  $\bar{\downarrow}$  (the falling edge), and differs depending on the state of the CD player.

- (a) While stopped  
The CD player enters the Play state, and starts after 4 seconds. During this time, playback is at double speed\*.
- (b) During play pause  
The CD player pauses at the beginning of the current tune, and after 4 seconds begins playing.
- (c) While open  
When the tray is loaded, the player enters the Play state.  
Output is not at double speed.
- (d) During shuffled play  
Play is shuffled, and (a) and (b) are executed.
- (e) During program play  
Program play begins, and (a) and (b) are executed.

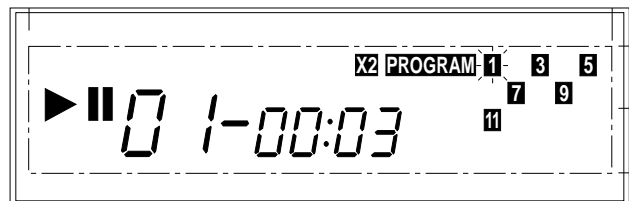
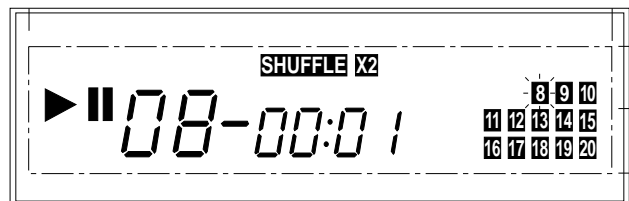
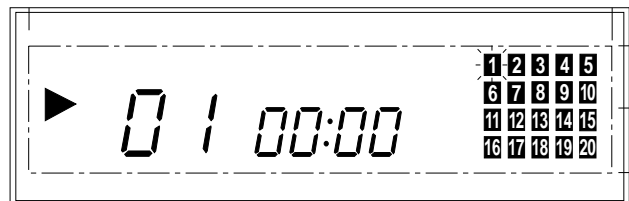
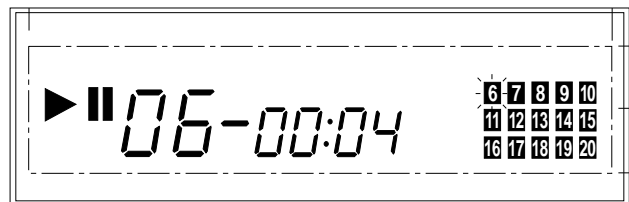
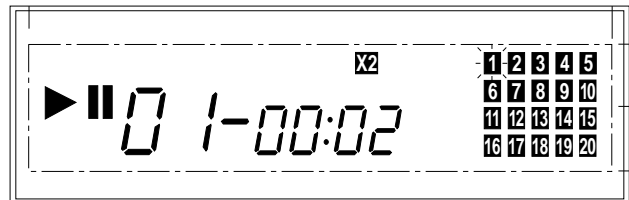

\* They are not executed if Pin 69 (SPD2) doesn't have a double speed circuit.

**17. Index search (remote control only)**

Pressing or causes index search.

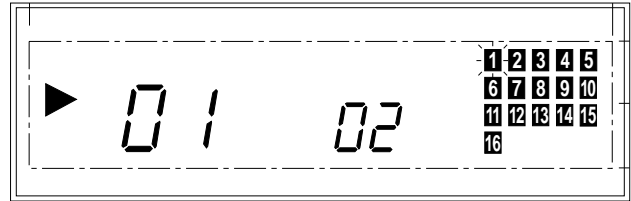

**18. Pitch control**

The playing speed can be varied with the range of 16%, so that a desirable interval can be achieved during disc playing of karaoke, and others.

- Press or . The pitch control ramp is lightened and the control value of playing speed is displayed.

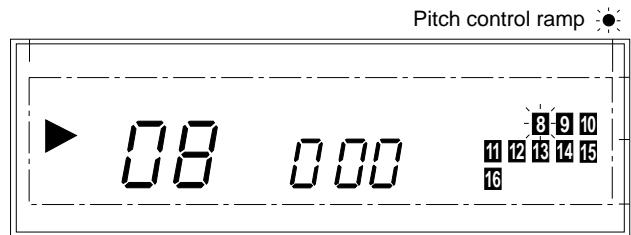

- The pitch varies by 1% every time or is pressed.

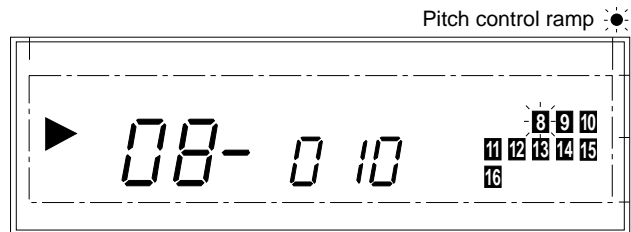
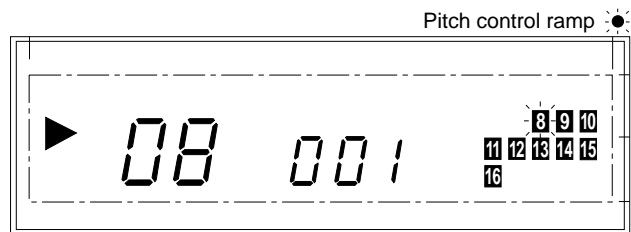

- The operation becomes normal state after five seconds of or operation.

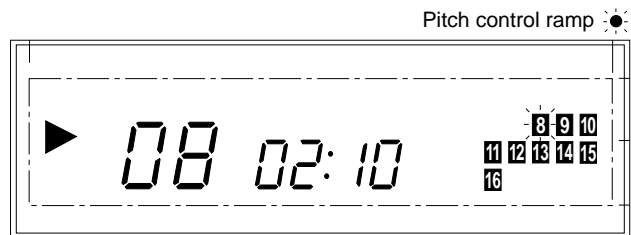

- Pressing returns the playing speed to the normal state, with the pitch control ramp lightened.

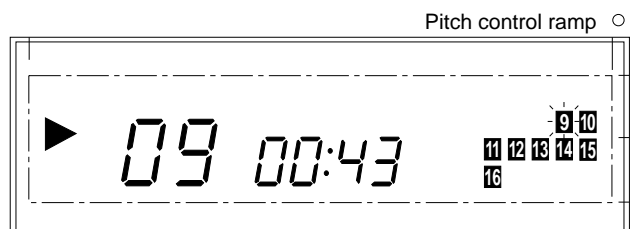

- When playing is stopped or the tray is open, the pitch control becomes off.

## 19. External control

On/off control can be executed for a voice canceler.

- Pin 70 (EXTCTL), the external control output, is switched between "H" and "L" every time pressing **EXCTL**.

**Note)** The voice cancel circuit is not incorporated. An external circuit is required when this function is used.

## Description of Operation

### 20. Test Mode

Branching to Test mode is achieved by setting Pin 62 (TEST IN) to "L". When Pin 62 (TEST IN) is set "L" and Reset Start is executed, focus searching is repeated at the current pickup location.

If a disc is loaded, the focus is turned on, the CLV-A and tracking sled servo are turned on, mute is turned off, and play is begun.

→In deck mode, the **OPEN** key can be used to operate the tray. When the tray closes, focus searching is begun.









→In portable/radio cassette mode, operation does not begin until the lid is closed. When the lid is closed, focus searching is begun.



#### (a) Focus bias

When reset is executed without a disc loaded, the lens is moved up and down in approximately one second intervals.

#### (b) Running check

When reset is executed with a disc loaded, focus searching, focus on, CLV-A, and tracking sled servo are set on, mute is turned off, and play is begun. At this time, the following key operations are possible.

-  = All servo off
- , ,  = Repeated focus searching. When a disc is loaded, play is begun.
-  = CLV-P, tracking on, sled on
-  = CLV-A, tracking off, sled off
-  = Fast-forward 200 track jump (during play only)
-  = Fast-rewind 200 track jump (during play only)

\* During  and  operation only, the current track number is displayed in the Track No. field of the display.

## Absolute Maximum Ratings

(Ta = -20 to +75°C, Vss = 0V)

Item	Symbol	Rating	Unit	Remarks
Supply voltage	V <sub>DD</sub>	-0.3 to +7.0	V	
LCD bias voltage	V <sub>LC1</sub> , V <sub>LC2</sub> , V <sub>LC3</sub>	-0.3 to +7.0* <sup>1</sup>	V	
Input voltage	V <sub>IN</sub>	-0.3 to +7.0* <sup>1</sup>	V	
Output voltage	V <sub>OUT</sub>	-0.3 to +7.0* <sup>1</sup>	V	
High level output current	I <sub>OH</sub>	-5	mA	General purpose port 1 pins* <sup>2</sup>
High level total output current	∑I <sub>OH</sub>	-50	mA	Total for all output pins
Low level output current	I <sub>OL</sub>	15	mA	General purpose port 1 pins* <sup>2</sup>
	I <sub>OLC</sub>	20	mA	High current port 1 pins* <sup>3</sup>
Low level total output current	∑I <sub>OL</sub>	100	mA	Total for all output pins
Operating temperature	T <sub>opr</sub>	-20 to +75	°C	
Storage temperature	T <sub>stg</sub>	-55 to +150	°C	
Allowable power dissipation	P <sub>D</sub>	600	mW	

\*<sup>1</sup> V<sub>LC1</sub>, V<sub>LC2</sub>, V<sub>LC3</sub>, V<sub>IN</sub> and V<sub>OUT</sub> must not exceed V<sub>DD</sub> + 0.3V.\*<sup>2</sup> PA to PD, PX0 to PX2, PY0, PY1.\*<sup>3</sup> The high current transistors are the N-CH transistors of the PC and PD ports.

**Note)** Usage exceeding absolute maximum ratings may permanently impair the LSI. Normal operation should be conducted under the recommended operating conditions. Exceeding these conditions may adversely affect the reliability of the LSI.

## Recommended Operating Conditions

(Vss = 0V)

Item	Symbol	Min.	Max.	Unit	Remarks
Supply voltage	V <sub>DD</sub>	4.5	5.5	V	
LCD bias voltage	V <sub>LC1</sub> , V <sub>LC2</sub> , V <sub>LC3</sub>	V <sub>SS</sub>	V <sub>DD</sub>	V	LCD power supply range* <sup>4</sup>
High level input voltage	V <sub>IH</sub>	0.7V <sub>DD</sub>	V <sub>DD</sub>	V	
	V <sub>IHS</sub>	0.8V <sub>DD</sub>	V <sub>DD</sub>	V	Hysteresis input* <sup>5</sup>
	V <sub>IHEX</sub>	V <sub>DD</sub> - 0.4	V <sub>DD</sub> + 0.3	V	EXTAL pin* <sup>6</sup>
Low level input voltage	V <sub>IL</sub>	0	0.3V <sub>DD</sub>	V	
	V <sub>ILS</sub>	0	0.2V <sub>DD</sub>	V	Hysteresis input* <sup>5</sup>
	V <sub>ILEX</sub>	-0.3	0.4	V	EXTAL pin* <sup>6</sup>
Operating temperature	T <sub>opr</sub>	-20	+75	°C	

\*<sup>4</sup> The optimum value will vary depending on the characteristics of the liquid crystal display.\*<sup>5</sup> Each pin of INT, RMC, PX0, PX3, PY2, PY3, and RST.\*<sup>6</sup> Specified only for external clock input.

Electrical Characteristics

DC characteristics

(Ta = -20 to +75°C, Vss = 0V)

Item	Symbol	Pin	Conditions	Min.	Typ.	Max.	Unit
High level output voltage	VOH	PA, PC, PD, PH PX0, PX1, PY0, PY1	VDD = 4.5V, IOH = -0.5mA	4.0			V
			VDD = 4.5V, IOH = -1.0mA	3.5			V
		PE, PF, PB, PI*1	VDD = 4.5V, IOH = -10µA	4.0			V
			VDD = 4.5V, IOH = -200µA	2.4			V
Low level output voltage	VOL	PA, PB, PE, PF PH, PI, PX0, PX1, PY0, PY1, VL, RST	VDD = 4.5V, IOL = 1.8mA			0.4	V
			VDD = 4.5V, IOL = 3.6mA			0.6	V
		PC, PD	VDD = 4.5V, IOL = 12mA			1.5	V
Input current	I <sub>IH</sub>	EXTAL*2	VDD = 5.5V, VIH = 5.5V	0.5		40	µA
	I <sub>I<sub>LE</sub></sub>			-0.5		-40	µA
	I <sub>I<sub>LR</sub></sub>	RST*3	VDD = 5.5V, VIL = 0.4V	-1.5		-400	µA
	I <sub>IL</sub>	PE to PF, PB, PI				±10	µA
Input/output leakage current	I <sub>I<sub>Z</sub></sub>	PX2, PY2, PY3, INT, RMC	VDD = 5.5V VI = 0, 5.5V			±10	µA
Common output impedance	R <sub>COM</sub>	COM0 to COM3	VDD = 5V VLC1 = 3.75V		3	5	kΩ
Segment output impedance	R <sub>SEG</sub>	SEG0 to SEG19	VLC2 = 2.5V VLC3 = 1.25V		5	15	kΩ
Supply current	I <sub>DD</sub>	VDD	VDD = 5.5V 4.19MHz crystal oscillator; all output pins open		7	20	mA
Input pin capacitance	C <sub>IN</sub>	All pins other than VLC1 to VLC3, COM0 to COM3, SEG0 to SEG15, SEG16 to SEG19, VDD, VSS	Clock 1MHz, 0V for pins other than those measured.		10	20	pF

\*1 Pull-up resistances selected for each of pins PE to PF, PB and PI.

\*2 Crystal or ceramic oscillator circuit selected.

\*3 Pull-up resistance selected for the RST pin.



AC Characteristics

(1) Clock timing

( $T_a = -20$  to  $+75^\circ\text{C}$ ,  $V_{DD} = 4.5$  to  $5.5\text{V}$ ,  $V_{SS} = 0\text{V}$ )

Item	Symbol	Pin	Conditions	Min.	Max.	Unit
System clock frequency	$f_c$	XTAL EXTAL	Figs. 1, 2	2	2	MHz
System clock input pulse width	$t_{XL}$ $t_{XH}$	EXTAL	Figs. 1, 2	90	200	ns
System clock input rise, fall times	$t_{CR}$ $t_{CF}$					

\*  $t_{sys} = 8/f_c$

**Note)** When accurately adjusting the frequency, conditions may differ from those of Fig. 2.

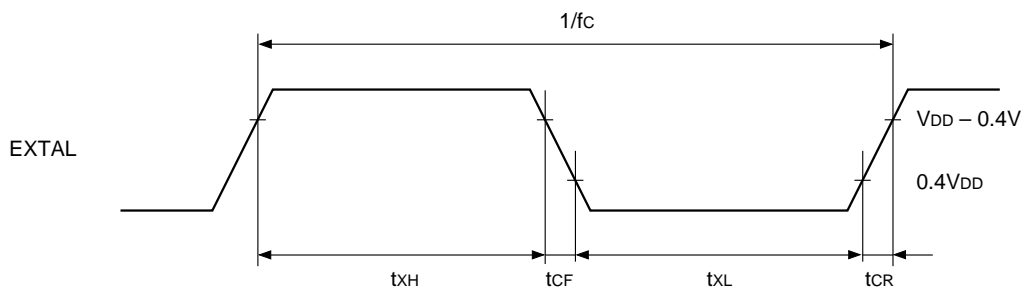

Fig. 1. Clock timing

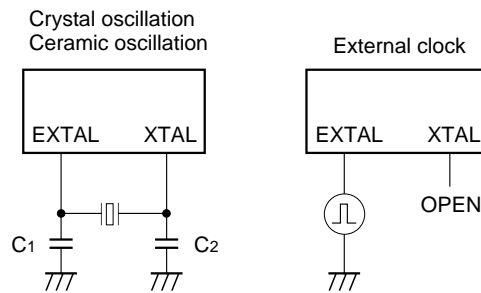

Fig. 2. Clock applied conditions

(2) Serial transfer

( $T_a = -20$  to  $+75^\circ\text{C}$ ,  $V_{DD} = 4.5$  to  $5.5\text{V}$ ,  $V_{SS} = 0\text{V}$ )

Item	Symbol	Pin	Conditions	Min.	Max.	Unit
Serial transfer clock ( $\overline{\text{SC}}$ ) cycle time	$t_{\text{KCY}}$	$\overline{\text{SC}}$	Input mode	$t_{\text{sys}}/4 + 1.42$		$\mu\text{s}$
			Output mode	$2t_{\text{sys}}$		$\mu\text{s}$
Serial transfer clock ( $\overline{\text{SC}}$ ) high-low level width	$t_{\text{KH}}$	$\overline{\text{SC}}$	Input mode	$t_{\text{sys}}/8 + 0.7$		$\mu\text{s}$
			Output mode*1	$t_{\text{sys}}/2 - 0.1$		$\mu\text{s}$
Serial data input set-up time (relative to $\overline{\text{SC}}$ )	$t_{\text{KL}}$	SI	$\overline{\text{SC}}$ input mode	0.1		$\mu\text{s}$
			$\overline{\text{SC}}$ output mode	0.2		$\mu\text{s}$
Serial data input hold time (relative to $\overline{\text{SC}}$ )	$t_{\text{SIK}}$	SI	$\overline{\text{SC}}$ input mode	$t_{\text{sys}}/8 + 0.5$		$\mu\text{s}$
			$\overline{\text{SC}}$ output mode	0.1		$\mu\text{s}$
Time delay from $\overline{\text{SC}}$ falling edge for high data output*2	$t_{\text{KSO}}$	SO			$t_{\text{sys}}/8 + 0.5$	$\mu\text{s}$
Delay time from $\overline{\text{SC}}$ falling edge for low data output	$t_{\text{KSO}}$	SO			$t_{\text{sys}}/8 + 0.5$	$\mu\text{s}$

Note)  $t_{\text{sys}} = 8/f_c$

\*1 Three-state output selected for  $\overline{\text{SC}}$  pin. As a result there are constraints on  $t_{\text{sys}}$ , and caution should be exercised in prescribing an upper limit to the system clock frequency  $f_c$ .

\*2 Three-state output selected for SO.

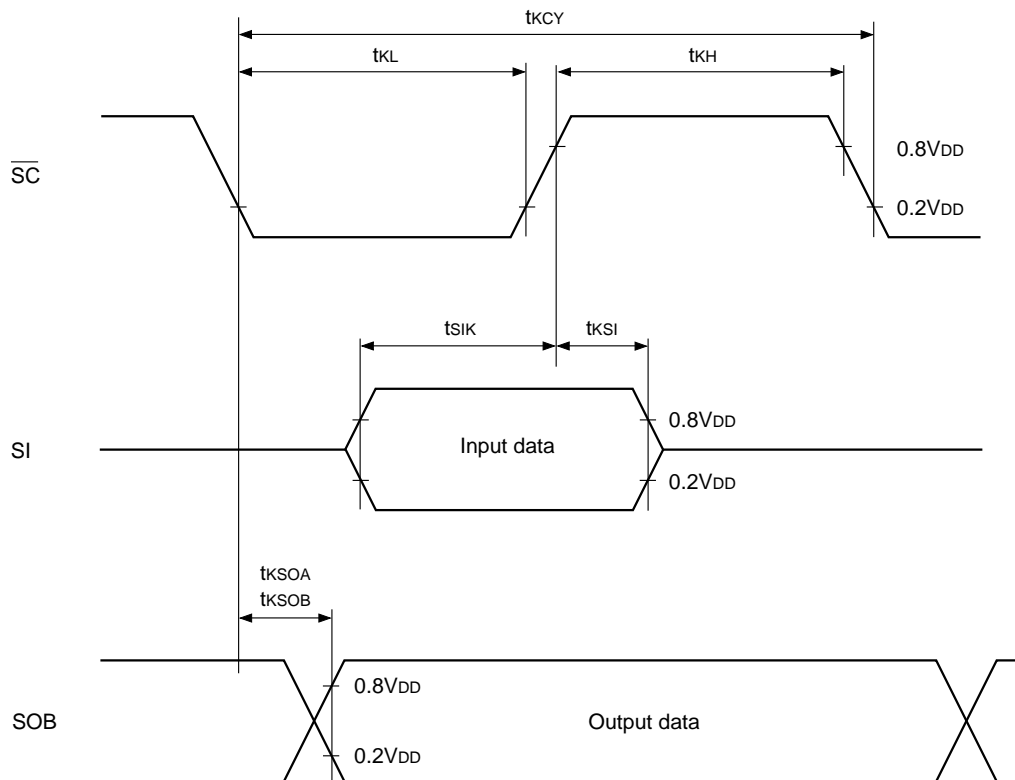

Fig. 3. Serial transfer timing

(3) Others

(Ta = -20 to +75°C, VDD = 4.5 to 5.5V, VSS = 0V)

Item	Symbol	Pin	Conditions	Min.	Max.	Unit
External interruption high, low level width	t <sub>1H</sub> , t <sub>1L</sub>	INT1	Edge detection mode	t <sub>sys</sub> + 0.05		μs
Reset input low level width	t <sub>RSL</sub>	$\overline{\text{RST}}$		2t <sub>sys</sub>		μs

Note) t<sub>sys</sub> = 8/fc

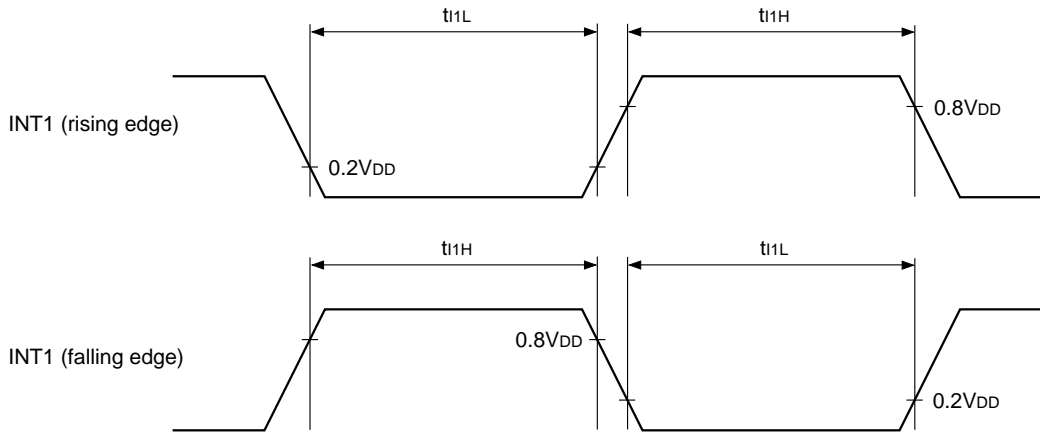

Fig. 4. Interruption input timing

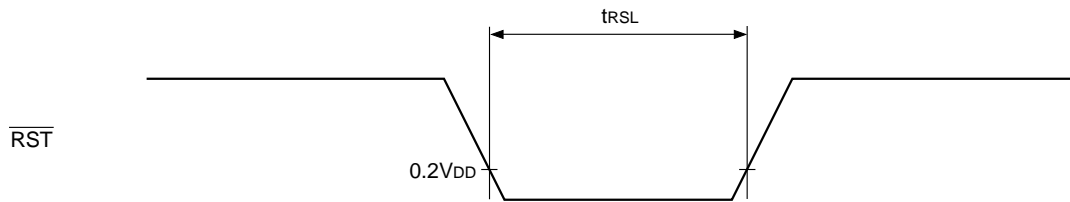
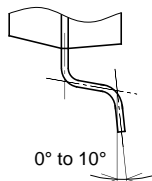
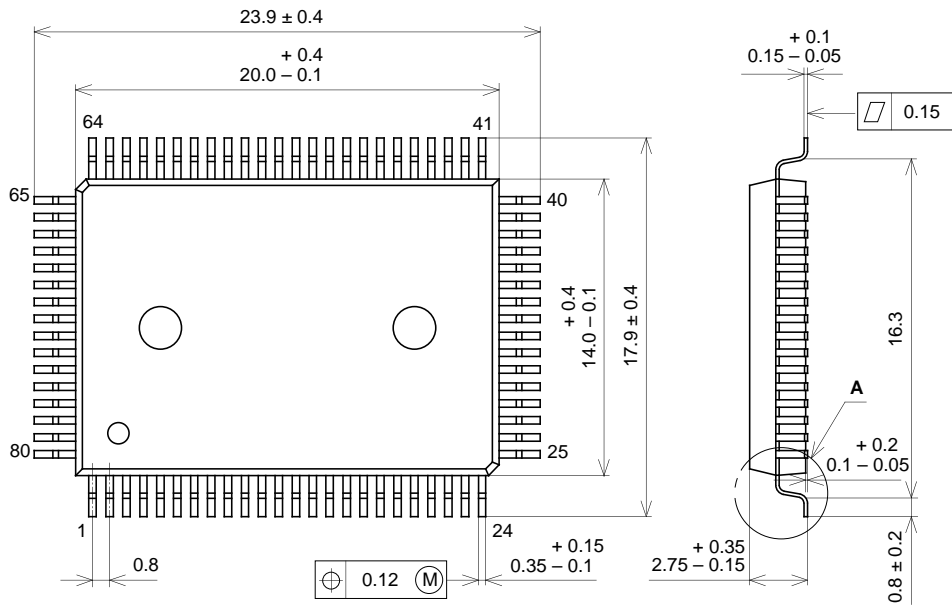

Fig. 5.  $\overline{\text{RST}}$  input timing

Package Outline Unit: mm

80PIN QFP (PLASTIC)



DETAIL A

PACKAGE STRUCTURE

SONY CODE	QFP-80P-L01
EIAJ CODE	*QFP080-P-1420-A
JEDEC CODE	_____

PACKAGE MATERIAL	EPOXY RESIN
LEAD TREATMENT	SOLDER PLATING
LEAD MATERIAL	COPPER / 42 ALLOY
PACKAGE WEIGHT	1.6g