

# 32K x 16 Static RAM

## Features

- 5.0V operation ( $\pm 10\%$ )
- High speed
  - $t_{AA} = 10$  ns
- Low active power
  - 825 mW (max., 10 ns, "L" version)
- Very Low standby power
  - 550  $\mu$ W (max., "L" version)
- Automatic power-down when deselected
- Independent Control of Upper and Lower bytes
- Available in 44-pin TSOP II and 400-mil SOJ

## Functional Description

The CY7C1020 is a high-performance CMOS static RAM organized as 32,768 words by 16 bits. This device has an automatic power-down feature that significantly reduces power consumption when deselected.

Writing to the device is accomplished by taking Chip Enable (CE) and Write Enable (WE) inputs LOW. If Byte Low Enable

(BLE) is LOW, then data from I/O pins (I/O<sub>1</sub> through I/O<sub>8</sub>), is written into the location specified on the address pins (A<sub>0</sub> through A<sub>14</sub>). If Byte High Enable (BHE) is LOW, then data from I/O pins (I/O<sub>9</sub> through I/O<sub>16</sub>) is written into the location specified on the address pins (A<sub>0</sub> through A<sub>14</sub>).

Reading from the device is accomplished by taking Chip Enable (CE) and Output Enable (OE) LOW while forcing the Write Enable (WE) HIGH. If Byte Low Enable (BLE) is LOW, then data from the memory location specified by the address pins will appear on I/O<sub>1</sub> to I/O<sub>8</sub>. If Byte High Enable (BHE) is LOW, then data from memory will appear on I/O<sub>9</sub> to I/O<sub>16</sub>. See the truth table at the back of this data sheet for a complete description of read and write modes.

The input/output pins (I/O<sub>1</sub> through I/O<sub>16</sub>) are placed in a high-impedance state when the device is deselected (CE HIGH), the outputs are disabled (OE HIGH), the BHE and BLE are disabled (BHE, BLE HIGH), or during a write operation (CE LOW, and WE LOW).

The CY7C1020 is available in standard 44-pin TSOP type II and 400-mil-wide SOJ packages.

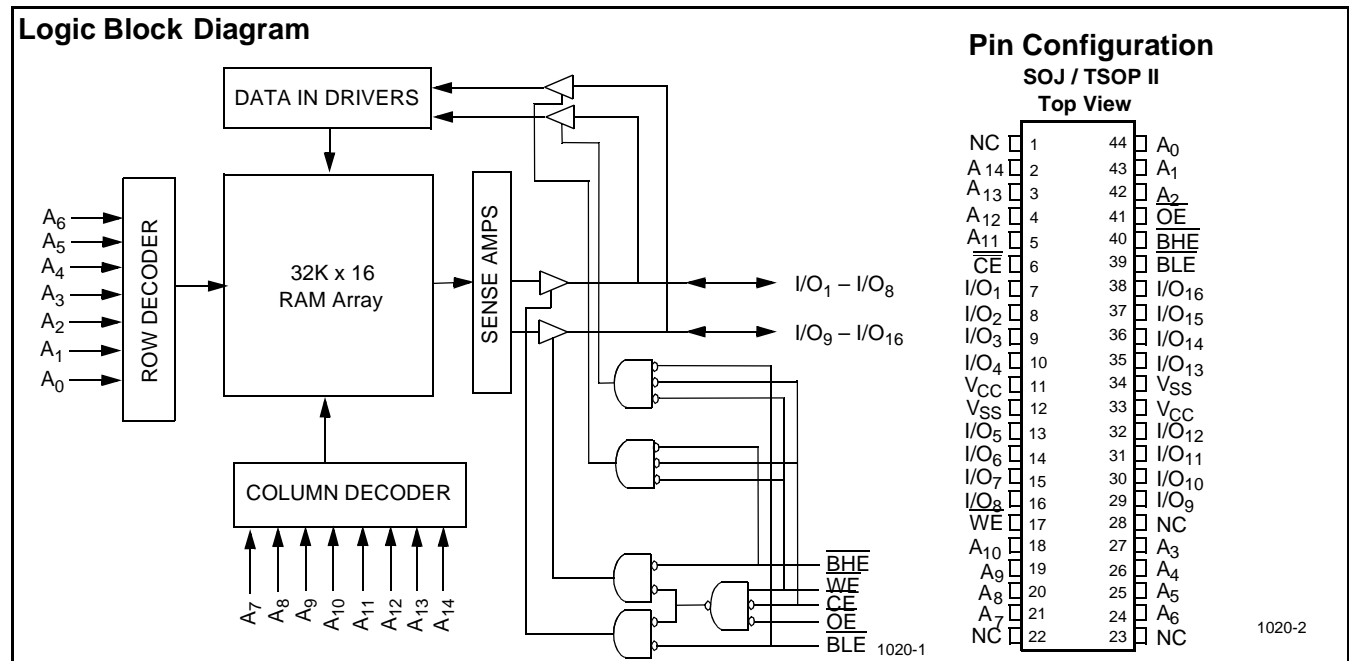

## Selection Guide

	7C1020-10	7C1020-12	7C1020-15	7C1020-20
Maximum Access Time (ns)	10	12	15	20
Maximum Operating Current (mA)		180	170	160
	L	150	140	130
Maximum CMOS Standby Current (mA)		3	3	3
	L	0.1	0.1	0.1

**Maximum Ratings**

(Above which the useful life may be impaired. For user guidelines, not tested.)

Storage Temperature ..... -65°C to +150°C  
 Ambient Temperature with  
 Power Applied..... -55°C to +125°C  
 Supply Voltage on V<sub>CC</sub> to Relative GND<sup>[1]</sup> .... -0.5V to +7.0V  
 DC Voltage Applied to Outputs  
 in High Z State<sup>[1]</sup> ..... -0.5V to V<sub>CC</sub> +0.5V  
 DC Input Voltage<sup>[1]</sup> ..... -0.5V to V<sub>CC</sub> +0.5V

Current into Outputs (LOW) ..... 20 mA  
 Static Discharge Voltage ..... >2001V  
 (per MIL-STD-883, Method 3015)  
 Latch-Up Current..... >200 mA

**Operating Range**

Range	Ambient Temperature <sup>[2]</sup>	V <sub>CC</sub>
Commercial	0°C to +70°C	4.5V–5.5V

**Electrical Characteristics** Over the Operating Range

Parameter	Description	Test Conditions	7C1020-10		7C1020-12		7C1020-15		Unit
			Min.	Max.	Min.	Max.	Min.	Max.	
V <sub>OH</sub>	Output HIGH Voltage	V <sub>CC</sub> = Min., I <sub>OH</sub> = -4.0 mA	2.4		2.4		2.4		V
V <sub>OL</sub>	Output LOW Voltage	V <sub>CC</sub> = Min., I <sub>OL</sub> = 8.0 mA		0.4		0.4		0.4	V
V <sub>IH</sub>	Input HIGH Voltage		2.2	6.0	2.2	6.0	2.2	6.0	V
V <sub>IL</sub>	Input LOW Voltage <sup>[1]</sup>		-0.5	0.8	-0.5	0.8	-0.5	0.8	V
I <sub>IX</sub>	Input Load Current	GND ≤ V <sub>I</sub> ≤ V <sub>CC</sub>	-1	+1	-1	+1	-1	+1	μA
I <sub>OZ</sub>	Output Leakage Current	GND ≤ V <sub>I</sub> ≤ V <sub>CC</sub> , Output Disabled	-2	+2	-2	+2	-2	+2	μA
I <sub>CC</sub>	V <sub>CC</sub> Operating Supply Current	V <sub>CC</sub> = Max., I <sub>OUT</sub> = 0 mA, f = f <sub>MAX</sub> = 1/t <sub>RC</sub>		180		170		160	mA
			L	150		140		130	
I <sub>SB1</sub>	Automatic CE Power-Down Current —TTL Inputs	Max. V <sub>CC</sub> , $\overline{CE} \geq V_{IH}$ V <sub>IN</sub> ≥ V <sub>IH</sub> or V <sub>IN</sub> ≤ V <sub>IL</sub> , f = f <sub>MAX</sub>		20		20		20	mA
			L	10		10		10	
I <sub>SB2</sub>	Automatic CE Power-Down Current —CMOS Inputs	Max. V <sub>CC</sub> , CE ≥ V <sub>CC</sub> - 0.3V, V <sub>IN</sub> ≥ V <sub>CC</sub> - 0.3V, or V <sub>IN</sub> ≤ 0.3V, f = 0		3		3		3	mA
			L	100		100		100	μA

**Notes:**

- V<sub>IL</sub> (min.) = -2.0V for pulse durations of less than 20 ns.
- T<sub>A</sub> is the case temperature.

**Electrical Characteristics** Over the Operating Range (continued)

Parameter	Description	Test Conditions	7C1020-20		Unit
			Min.	Max.	
$V_{OH}$	Output HIGH Voltage	$V_{CC} = \text{Min.}, I_{OH} = -4.0 \text{ mA}$	2.4		V
$V_{OL}$	Output LOW Voltage	$V_{CC} = \text{Min.}, I_{OL} = 8.0 \text{ mA}$		0.4	V
$V_{IH}$	Input HIGH Voltage		2.2	6.0	V
$V_{IL}$	Input LOW Voltage <sup>[1]</sup>		-0.5	0.8	V
$I_{IX}$	Input Load Current	$GND \leq V_I \leq V_{CC}$	-1	+1	$\mu\text{A}$
$I_{OZ}$	Output Leakage Current	$GND \leq V_I \leq V_{CC}$ , Output Disabled	-2	+2	$\mu\text{A}$
$I_{CC}$	$V_{CC}$ Operating Supply Current	$V_{CC} = \text{Max.}, I_{OUT} = 0 \text{ mA}, f = f_{MAX} = 1/t_{RC}$		160	mA
			L	130	
$I_{SB1}$	Automatic CE Power-Down Current —TTL Inputs	Max. $V_{CC}$ , $\overline{CE} \geq V_{IH}$ $V_{IN} \geq V_{IH}$ or $V_{IN} \leq V_{IL}$ , $f = f_{MAX}$		20	mA
			L	10	
$I_{SB2}$	Automatic CE Power-Down Current —CMOS Inputs	Max. $V_{CC}$ , $\overline{CE} \geq V_{CC} - 0.3\text{V}$ , $V_{IN} \geq V_{CC} - 0.3\text{V}$ , or $V_{IN} \leq 0.3\text{V}$ , $f = 0$		3	mA
			L	100	$\mu\text{A}$

**Capacitance<sup>[3]</sup>**

Parameter	Description	Test Conditions	Max.	Unit
$C_{IN}$	Input Capacitance	$T_A = 25^\circ\text{C}, f = 1 \text{ MHz}, V_{CC} = 5.0\text{V}$	8	pF
$C_{OUT}$	Output Capacitance		8	pF

**Note:**

3. Tested initially and after any design or process changes that may affect these parameters.

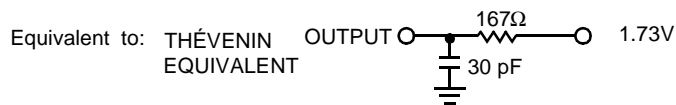
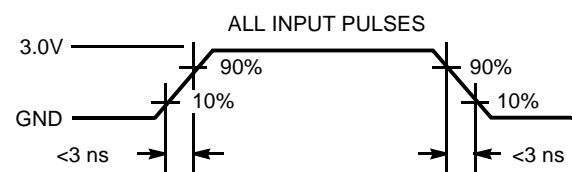
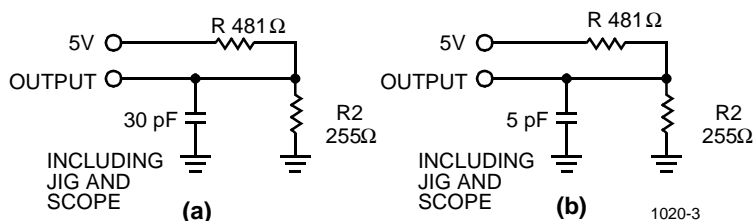
**AC Test Loads and Waveforms**

1020-4

**Switching Characteristics<sup>[4]</sup> Over the Operating Range**

Parameter	Description	7C1020-10		7C1020-12		7C1020-15		7C1020-20		Unit
		Min.	Max.	Min.	Max.	Min.	Max.	Min.	Max.	
<b>READ CYCLE</b>										
t <sub>RC</sub>	Read Cycle Time	10		12		15		20		ns
t <sub>AA</sub>	Address to Data Valid		10		12		15		20	ns
t <sub>OHA</sub>	Data Hold from Address Change	3		3		3		3		ns
t <sub>ACE</sub>	$\overline{CE}$ LOW to Data Valid		10		12		15		20	ns
t <sub>DOE</sub>	$\overline{OE}$ LOW to Data Valid		5		5		7		9	ns
t <sub>LZOE</sub>	$\overline{OE}$ LOW to Low Z	0		0		0		0		ns
t <sub>HZOE</sub>	$\overline{OE}$ HIGH to High Z <sup>[5, 6]</sup>		5		6		7		8	ns
t <sub>LZCE</sub>	$\overline{CE}$ LOW to Low Z <sup>[6]</sup>	3		3		3		3		ns
t <sub>HZCE</sub>	$\overline{CE}$ HIGH to High Z <sup>[5, 6]</sup>		5		6		7		8	ns
t <sub>PU</sub>	$\overline{CE}$ LOW to Power-Up	0		0		0		0		ns
t <sub>PD</sub>	$\overline{CE}$ HIGH to Power-Down		12		12		15		20	ns
t <sub>DBE</sub>	Byte enable to Data Valid		5		6		7		9	ns
t <sub>LZBE</sub>	Byte enable to Low Z	0		0		0		0		ns
t <sub>HZBE</sub>	Byte disable to High Z		5		6		7		9	ns
<b>WRITE CYCLE<sup>[7]</sup></b>										
t <sub>WC</sub>	Write Cycle Time	10		12		15		12		ns
t <sub>SCE</sub>	$\overline{CE}$ LOW to Write End	8		9		10		12		ns
t <sub>AW</sub>	Address Set-Up to Write End	7		8		10		12		ns
t <sub>HA</sub>	Address Hold from Write End	0		0		0		0		ns
t <sub>SA</sub>	Address Set-Up to Write Start	0		0		0		0		ns
t <sub>PWE</sub>	$\overline{WE}$ Pulse Width	7		8		10		12		ns
t <sub>SD</sub>	Data Set-Up to Write End	5		6		10		10		ns
t <sub>HD</sub>	Data Hold from Write End	0		0		0		0		ns
t <sub>LZWE</sub>	$\overline{WE}$ HIGH to Low Z <sup>[6]</sup>	3		3		3		3		ns
t <sub>HZWE</sub>	$\overline{WE}$ LOW to High Z <sup>[5, 6]</sup>		5		6		7		9	ns
t <sub>BW</sub>	Byte enable to end of write	7		8		9		12		ns

**Notes:**

- Test conditions assume signal transition time of 3 ns or less, timing reference levels of 1.5V, input pulse levels of 0 to 3.0V, and output loading of the specified I<sub>OL</sub>/I<sub>OH</sub> and 30-pF load capacitance.
- t<sub>HZOE</sub>, t<sub>HZBE</sub>, t<sub>HZCE</sub>, and t<sub>HZWE</sub> are specified with a load capacitance of 5 pF as in part (b) of AC Test Loads. Transition is measured ±500 mV from steady-state voltage.
- At any given temperature and voltage condition, t<sub>HZCE</sub> is less than t<sub>LZCE</sub>, t<sub>HZOE</sub> is less than t<sub>LZOE</sub>, and t<sub>HZWE</sub> is less than t<sub>LZWE</sub> for any given device.
- The internal write time of the memory is defined by the overlap of  $\overline{CE}$  LOW,  $\overline{WE}$  LOW and BHE / BLE LOW. CE, WE and BHE / BLE must be LOW to initiate a write, and the transition of these signals can terminate the write. The input data set-up and hold timing should be referenced to the leading edge of the signal that terminates the write.

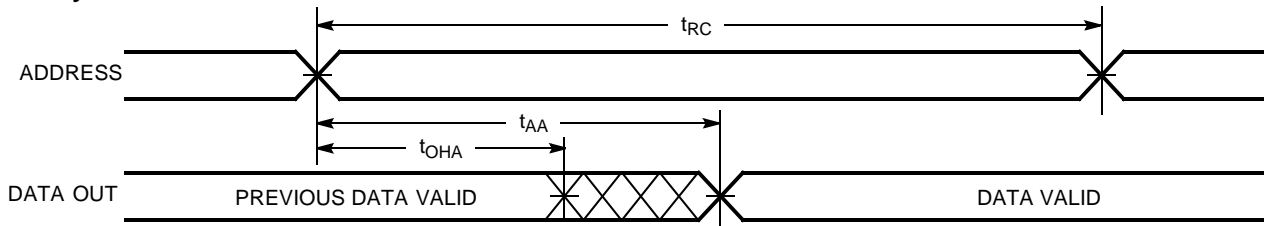
**Switching Waveforms**
**Read Cycle No. 1** <sup>[8, 9]</sup>

1020-5

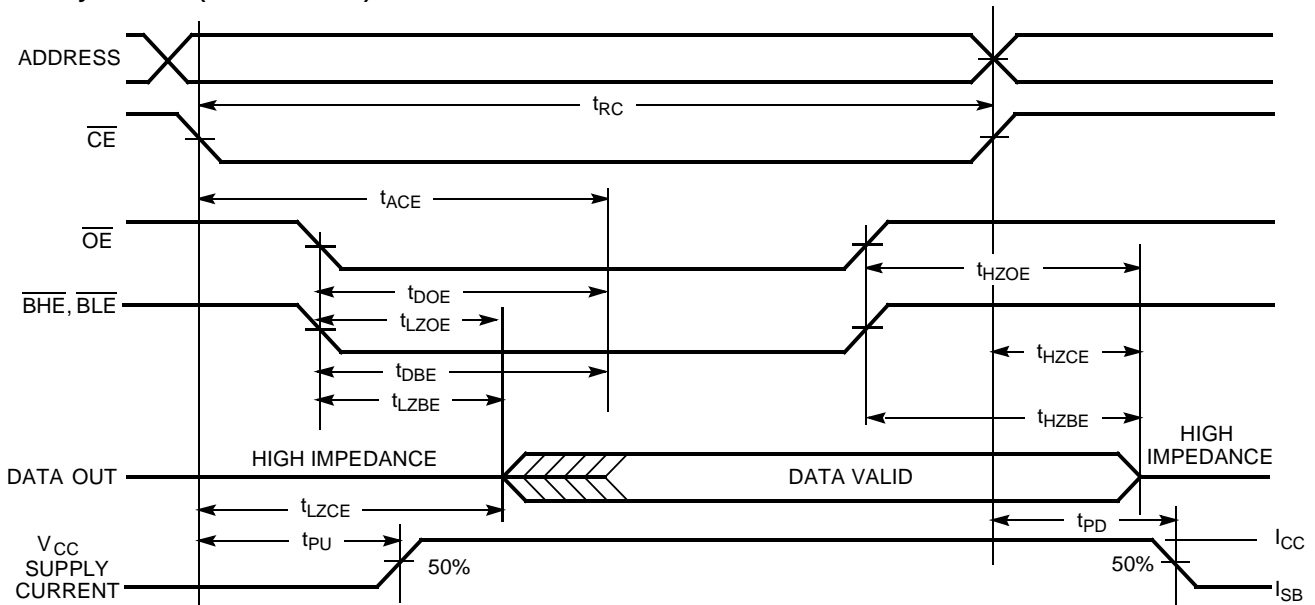
**Read Cycle No. 2 (OE Controlled)** <sup>[9, 10]</sup>

1020-6

**Notes:**

8. Device is continuously selected.  $\overline{OE}$ ,  $\overline{CE}$ ,  $\overline{BHE}$  and/or  $\overline{BLA} = V_{IL}$ .
9.  $\overline{WE}$  is HIGH for read cycle.
10. Address valid prior to or coincident with  $\overline{CE}$  transition LOW.

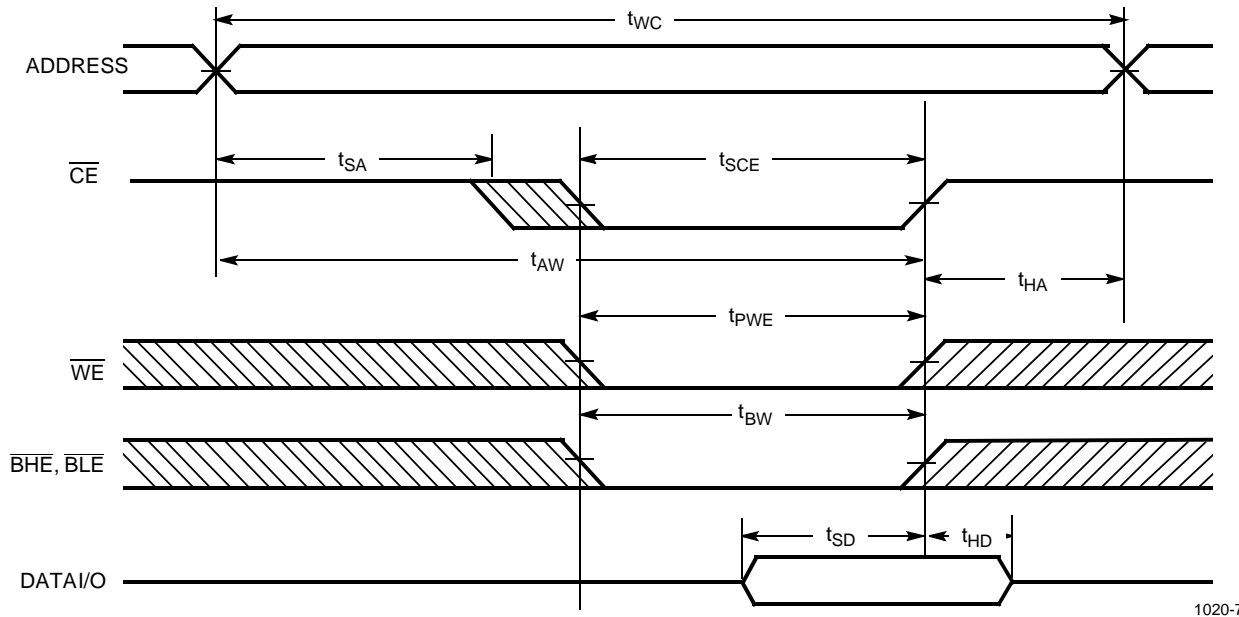
**Switching Waveforms (continued)**
**Write Cycle No. 1 ( $\overline{\text{CE}}$  Controlled)<sup>[11, 12]</sup>**

1020-7

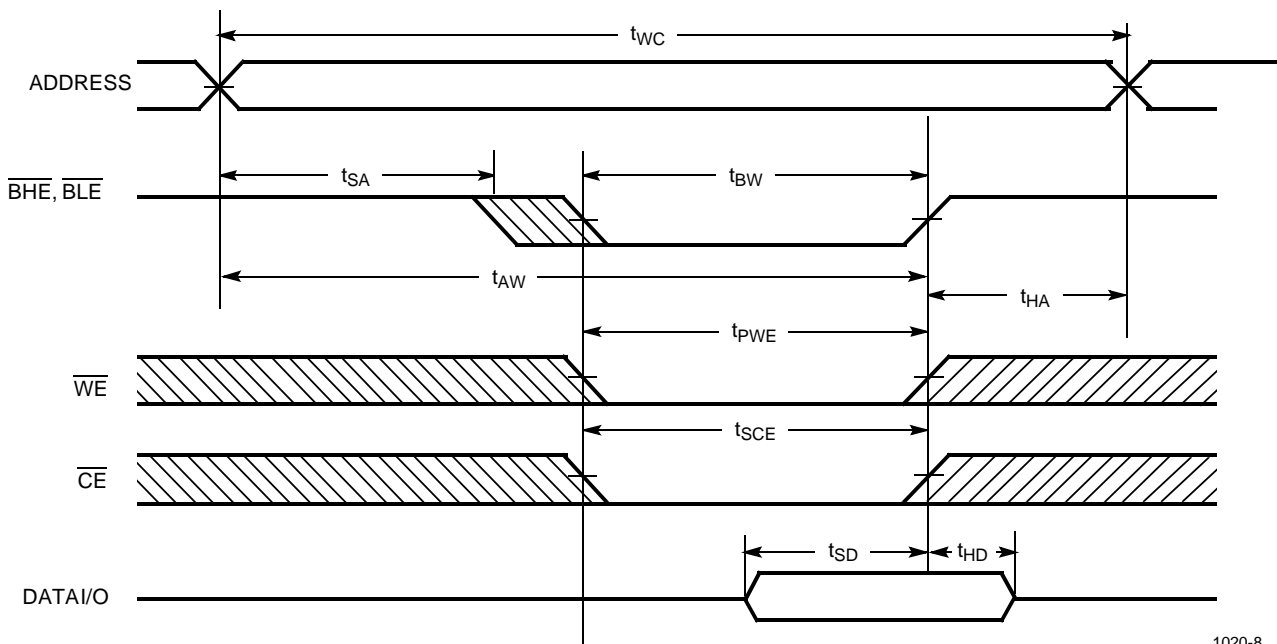
**Write Cycle No. 2 ( $\overline{\text{BLE}}$  or  $\overline{\text{BHE}}$  Controlled)**

1020-8

**Notes:**

11. Data I/O is high impedance if  $\overline{\text{OE}}$  or  $\overline{\text{BHE}}$  and/or  $\overline{\text{BLE}} = V_{IH}$ .
12. If  $\overline{\text{CE}}$  goes HIGH simultaneously with  $\overline{\text{WE}}$  going HIGH, the output remains in a high-impedance state.

**Switching Waveforms** (continued)

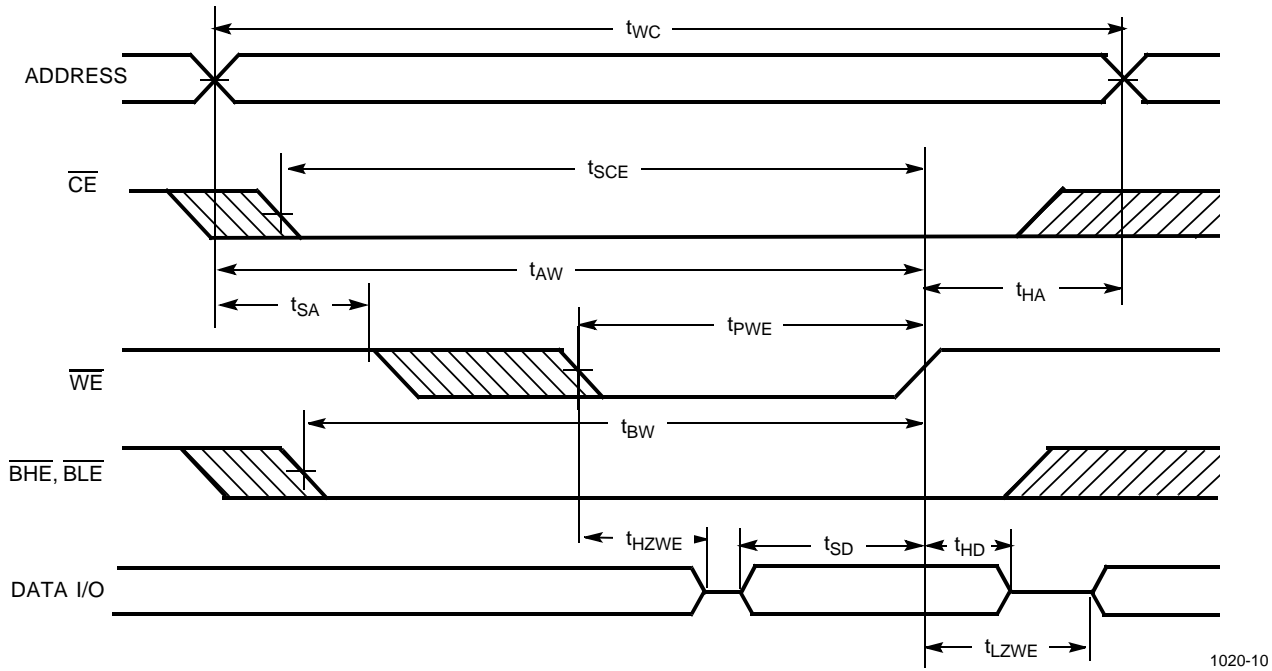
**Write Cycle No.3 ( $\overline{WE}$  Controlled,  $\overline{OE}$  LOW)**

1020-10

**Truth Table**

CE	OE	WE	BLE	BHE	I/O <sub>1</sub> -I/O <sub>8</sub>	I/O <sub>9</sub> -I/O <sub>16</sub>	Mode	Power
H	X	X	X	X	High Z	High Z	Power-Down	Standby ( $I_{SB}$ )
L	L	H	L	L	Data Out	Data Out	Read - All bits	Active ( $I_{CC}$ )
			L	H	Data Out	High Z	Read - Lower bits only	Active ( $I_{CC}$ )
			H	L	High Z	Data Out	Read - Upper bits only	Active ( $I_{CC}$ )
L	X	L	L	L	Data In	Data In	Write - All bits	Active ( $I_{CC}$ )
			L	H	Data In	High Z	Write - Lower bits only	Active ( $I_{CC}$ )
			H	L	High Z	Data In	Write - Upper bits only	Active ( $I_{CC}$ )
L	H	H	X	X	High Z	High Z	Selected, Outputs Disabled	Active ( $I_{CC}$ )
L	X	X	H	H	High Z	High Z	Selected, Outputs Disabled	Active ( $I_{CC}$ )

**Ordering Information**

Speed (ns)	Ordering Code	Package Name	Package Type	Operating Range
10	CY7C1020-10VC	V34	44-Lead (400-Mil) Molded SOJ	Commercial
	CY7C1020L-10VC	V34	44-Lead (400-Mil) Molded SOJ	Commercial
	CY7C1020-10ZC	Z44	44-Lead TSOP Type II	Commercial
	CY7C1020L-10ZC	Z44	44-Lead TSOP Type II	Commercial
12	CY7C1020-12VC	V34	44-Lead (400-Mil) Molded SOJ	Commercial
	CY7C1020L-12VC	V34	44-Lead (400-Mil) Molded SOJ	Commercial
	CY7C1020-12ZC	Z44	44-Lead TSOP Type II	Commercial
	CY7C1020L-12ZC	Z44	44-Lead TSOP Type II	Commercial
15	CY7C1020-15VC	V34	44-Lead (400-Mil) Molded SOJ	Commercial
	CY7C1020L-15VC	V34	44-Lead (400-Mil) Molded SOJ	Commercial
	CY7C1020-15ZC	Z44	44-Lead TSOP Type II	Commercial
	CY7C1020L-15ZC	Z44	44-Lead TSOP Type II	Commercial
20	CY7C1020-20VC	V34	44-Lead (400-Mil) Molded SOJ	Commercial
	CY7C1020L-20VC	V34	44-Lead (400-Mil) Molded SOJ	Commercial
	CY7C1020-20ZC	Z44	44-Lead TSOP Type II	Commercial
	CY7C1020L-20ZC	Z44	44-Lead TSOP Type II	Commercial

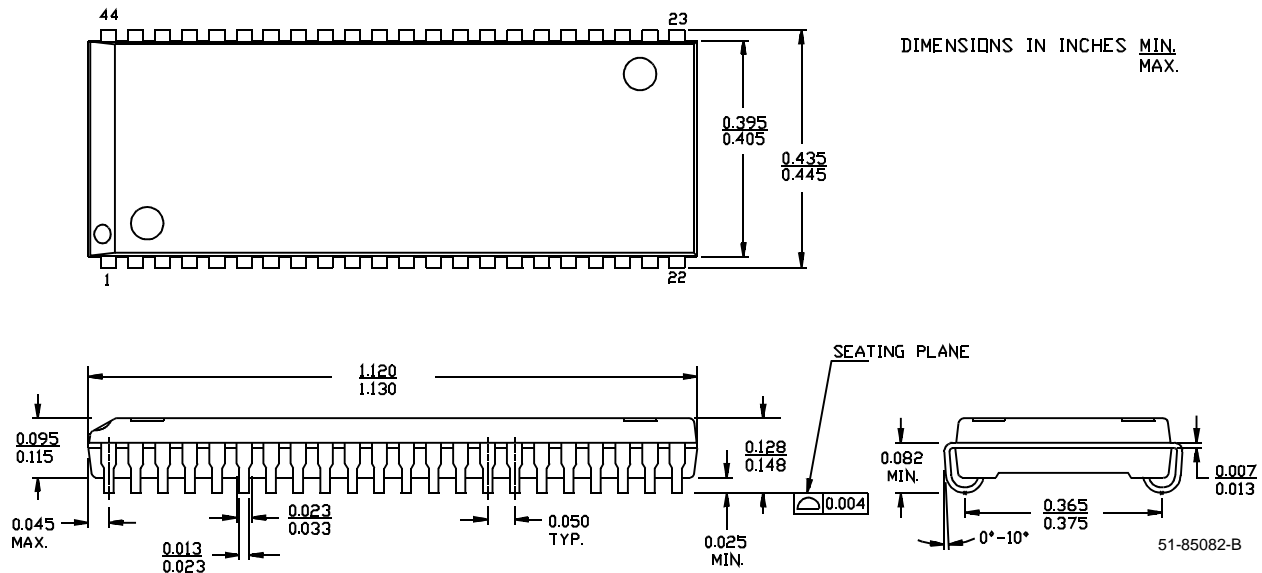
**Package Diagrams**
**44-Lead (400-Mil) Molded SOJ V34**



**Package Diagrams** (continued)

**44-Pin TSOP II Z44**

DIMENSION IN MM (INCH)  
MAX  
MIN.

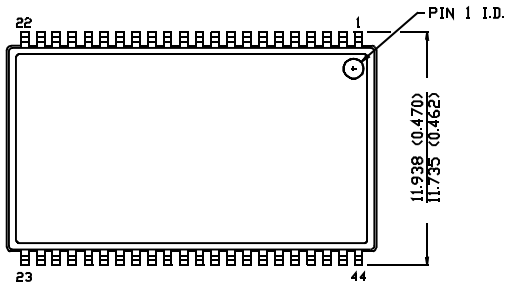

TOP VIEW

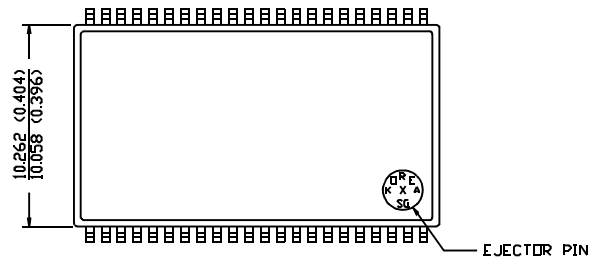

BOTTOM VIEW

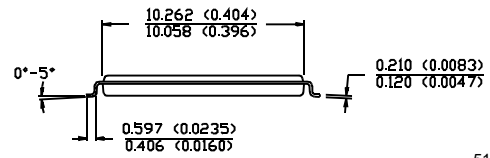
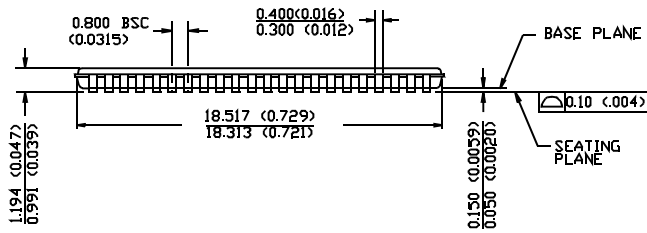

51-85087-A

<b>Document Title: CY7C1020 32K x 16 Static RAM</b> <b>Document Number: 38-05058</b>				
<b>REV.</b>	<b>ECN NO.</b>	<b>Issue Date</b>	<b>Orig. of Change</b>	<b>Description of Change</b>
**	107249	09/10/01	SZV	Change from Spec number: 38-00542 to 38-05058