

EMT2DXV6T5

Dual General Purpose Transistor

PNP Dual

This transistor is designed for general purpose amplifier applications. It is housed in the SOT-563 which is designed for low power surface mount applications.

- Lead-Free Solder Plating
- Low $V_{CE(SAT)}$, < 0.5 V

MAXIMUM RATINGS

Rating	Symbol	Value	Unit
Collector-Emitter Voltage	V_{CEO}	-60	V
Collector-Base Voltage	V_{CBO}	-50	V
Emitter-Base Voltage	V_{EBO}	-6.0	V
Collector Current - Continuous	I_C	-100	mAdc

THERMAL CHARACTERISTICS

Characteristic (One Junction Heated)	Symbol	Max	Unit
Total Device Dissipation $T_A = 25^\circ\text{C}$ Derate above 25°C	P_D	357 (Note 1) 2.9 (Note 1)	mW mW/ $^\circ\text{C}$
Thermal Resistance, Junction-to-Ambient	$R_{\theta JA}$	350 (Note 1)	$^\circ\text{C}/\text{W}$
Characteristic (Both Junctions Heated)	Symbol	Max	Unit
Total Device Dissipation $T_A = 25^\circ\text{C}$ Derate above 25°C	P_D	500 (Note 1) 4.0 (Note 1)	mW mW/ $^\circ\text{C}$
Thermal Resistance, Junction-to-Ambient	$R_{\theta JA}$	250 (Note 1)	$^\circ\text{C}/\text{W}$
Junction and Storage Temperature Range	T_J, T_{stg}	-55 to +150	$^\circ\text{C}$

1. FR-4 @ Minimum Pad.



ON Semiconductor®

<http://onsemi.com>

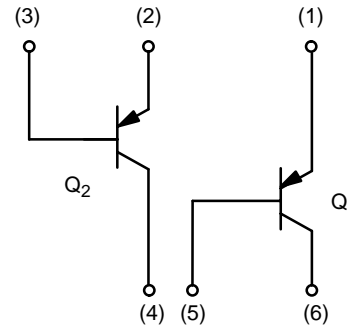

MARKING DIAGRAM

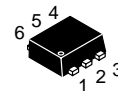

SOT-563
CASE 463A
Style 2

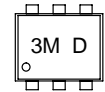

3M = Specific Device Code
D = Date Code

ORDERING INFORMATION

Device	Package	Shipping†
EMT2DXV6T5	SOT-563	2 mm Pitch 8000/Tape & Reel

†For information on tape and reel specifications, including part orientation and tape sizes, please refer to our Tape and Reel Packaging Specifications Brochure, BRD8011/D.

EMT2DXV6T5

ELECTRICAL CHARACTERISTICS ($T_A = 25^\circ\text{C}$)

Characteristic	Symbol	Min	Typ	Max	Unit
Collector–Base Breakdown Voltage ($I_C = -50 \mu\text{A}$, $I_E = 0$)	$V_{(BR)CBO}$	-60	-	-	Vdc
Collector–Emitter Breakdown Voltage ($I_C = -1.0 \text{mA}$, $I_B = 0$)	$V_{(BR)CEO}$	-50	-	-	Vdc
Emitter–Base Breakdown Voltage ($I_E = -50 \mu\text{A}$, $I_C = 0$)	$V_{(BR)EBO}$	-6.0	-	-	Vdc
Collector–Base Cutoff Current ($V_{CB} = -30 \text{Vdc}$, $I_E = 0$)	I_{CBO}	-	-	-0.5	nA
Emitter–Base Cutoff Current ($V_{EB} = -5.0 \text{Vdc}$, $I_B = 0$)	I_{EBO}	-	-	-0.5	μA
Collector–Emitter Saturation Voltage (Note 2) ($I_C = -50 \text{mA}$, $I_B = -5.0 \text{mA}$)	$V_{CE(sat)}$	-	-	-0.5	Vdc
DC Current Gain (Note 2) ($V_{CE} = -6.0 \text{Vdc}$, $I_C = -1.0 \text{mA}$)	h_{FE}	120	-	560	-
Transition Frequency ($V_{CE} = -12 \text{Vdc}$, $I_C = -2.0 \text{mA}$, $f = 30 \text{MHz}$)	f_T	-	140	-	MHz
Output Capacitance ($V_{CB} = -12 \text{Vdc}$, $I_E = 0 \text{A}$, $f = 1 \text{MHz}$)	C_{OB}	-	3.5	-	pF

2. Pulse Test: Pulse Width $\leq 300 \mu\text{s}$, D.C. $\leq 2\%$.

EMT2DXV6T5

TYPICAL ELECTRICAL CHARACTERISTICS

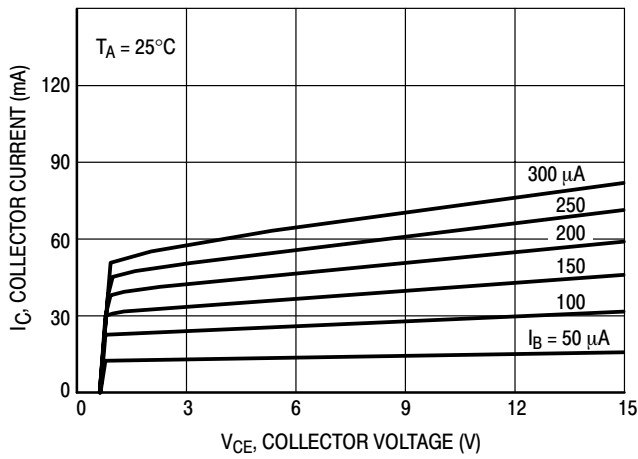

Figure 1. $I_C - V_{CE}$

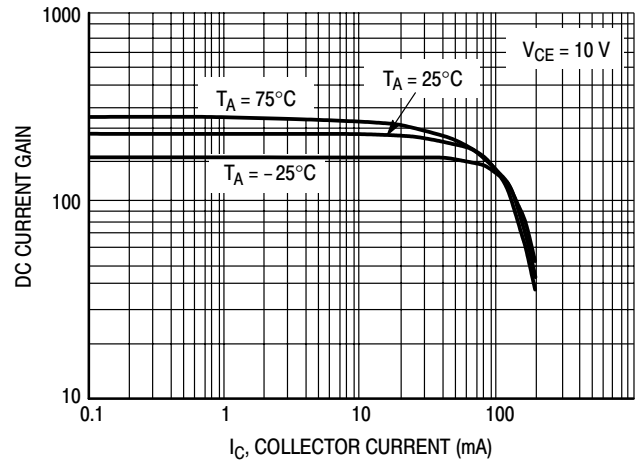

Figure 2. DC Current Gain

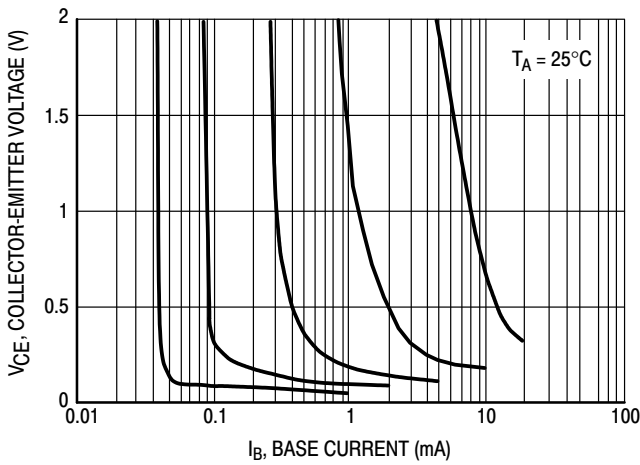

Figure 3. Collector Saturation Region

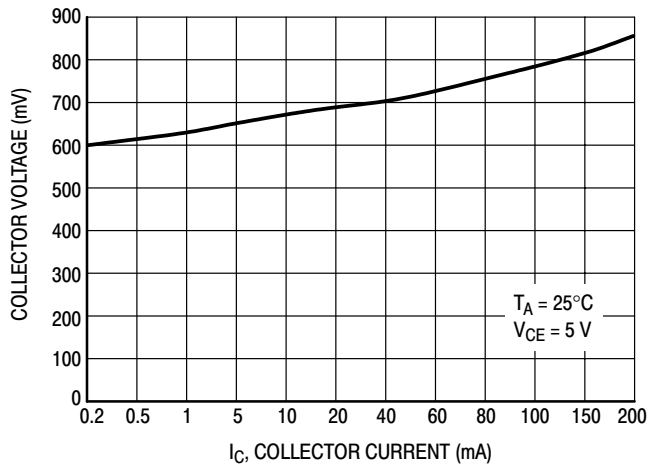

Figure 4. On Voltage

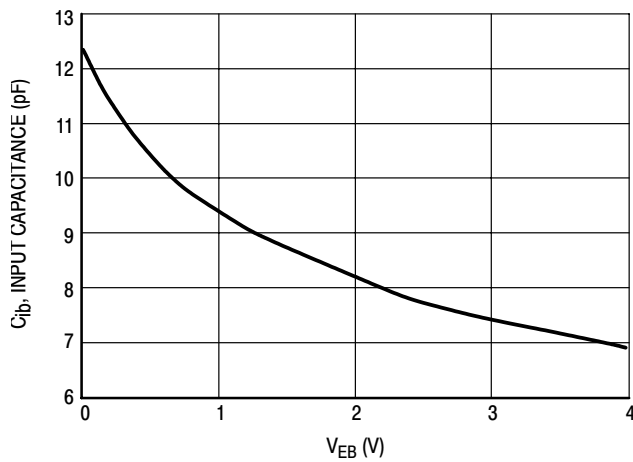

Figure 5. Capacitance

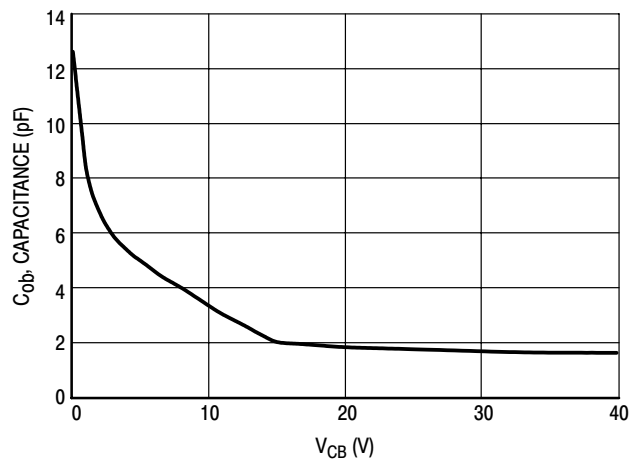
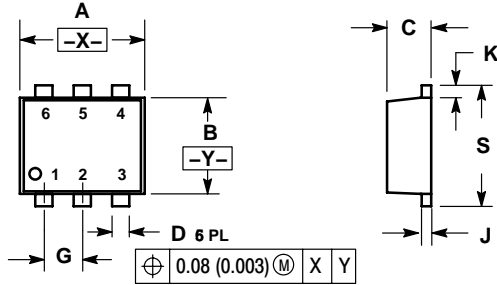

Figure 6. Capacitance

EMT2DXV6T5

PACKAGE DIMENSIONS

SOT-563, 6-LEAD
CASE 463A-01
ISSUE D



NOTES:

1. DIMENSIONING AND TOLERANCING PER ANSI Y14.5M, 1982.
2. CONTROLLING DIMENSION: MILLIMETERS
3. MAXIMUM LEAD THICKNESS INCLUDES LEAD FINISH THICKNESS. MINIMUM LEAD THICKNESS IS THE MINIMUM THICKNESS OF BASE MATERIAL.

DIM	MILLIMETERS		INCHES	
	MIN	MAX	MIN	MAX
A	1.50	1.70	0.059	0.067
B	1.10	1.30	0.043	0.051
C	0.50	0.60	0.020	0.024
D	0.17	0.27	0.007	0.011
G	0.50 BSC		0.020 BSC	
J	0.08	0.18	0.003	0.007
K	0.10	0.30	0.004	0.012
S	1.50	1.70	0.059	0.067

STYLE 2:

- PIN 1. EMITTER 1
- PIN 2. EMITTER 2
- PIN 3. BASE 2
- PIN 4. COLLECTOR 2
- PIN 5. BASE 1
- PIN 6. COLLECTOR 1

SOLDERING FOOTPRINT*

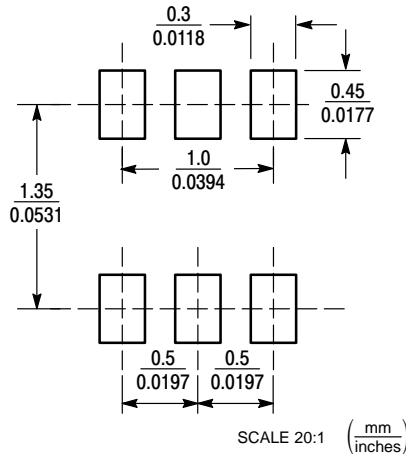

*For additional information on our Pb-Free strategy and soldering details, please download the ON Semiconductor Soldering and Mounting Techniques Reference Manual, SOLDERRM/D.

ON Semiconductor and are registered trademarks of Semiconductor Components Industries, LLC (SCILLC). SCILLC reserves the right to make changes without further notice to any products herein. SCILLC makes no warranty, representation or guarantee regarding the suitability of its products for any particular purpose, nor does SCILLC assume any liability arising out of the application or use of any product or circuit, and specifically disclaims any and all liability, including without limitation special, consequential or incidental damages. "Typical" parameters which may be provided in SCILLC data sheets and/or specifications can and do vary in different applications and actual performance may vary over time. All operating parameters, including "Typicals" must be validated for each customer application by customer's technical experts. SCILLC does not convey any license under its patent rights nor the rights of others. SCILLC products are not designed, intended, or authorized for use as components in systems intended for surgical implant into the body, or other applications intended to support or sustain life, or for any other application in which the failure of the SCILLC product could create a situation where personal injury or death may occur. Should Buyer purchase or use SCILLC products for any such unintended or unauthorized application, Buyer shall indemnify and hold SCILLC and its officers, employees, subsidiaries, affiliates, and distributors harmless against all claims, costs, damages, and expenses, and reasonable attorney fees arising out of, directly or indirectly, any claim of personal injury or death associated with such unintended or unauthorized use, even if such claim alleges that SCILLC was negligent regarding the design or manufacture of the part. SCILLC is an Equal Opportunity/Affirmative Action Employer. This literature is subject to all applicable copyright laws and is not for resale in any manner.

PUBLICATION ORDERING INFORMATION

LITERATURE FULFILLMENT:
Literature Distribution Center for ON Semiconductor
P.O. Box 5163, Denver, Colorado 80217 USA
Phone: 303-675-2175 or 800-344-3860 Toll Free USA/Canada
Fax: 303-675-2176 or 800-344-3867 Toll Free USA/Canada
Email: orderlit@onsemi.com

N. American Technical Support: 800-282-9855 Toll Free
USA/Canada

Japan: ON Semiconductor, Japan Customer Focus Center
2-9-1 Kamimeguro, Meguro-ku, Tokyo, Japan 153-0051
Phone: 81-3-5773-3850

ON Semiconductor Website: <http://onsemi.com>

Order Literature: <http://www.onsemi.com/litorder>

For additional information, please contact your local Sales Representative.