

LIQUID-CRYSTAL DISPLAY DRIVERS

4054B 4-SEGMENT DISPLAY DRIVER - STROBED LATCH FUNCTION

4055B BCD TO 7-SEGMENT DECODER/DRIVER, WITH "DISPLAY-FREQUENCY" OUTPUT

4056B BCD TO 7-SEGMENT DECODER/DRIVER WITH STROBED LATCH FUNCTION

- QUIESCENT CURRENT SPECIFIED TO 20V FOR HCC DEVICE
- OPERATION OF LIQUID CRYSTALS WITH COS/MOS CIRCUITS PROVIDES ULTRA-LOW-POWER DISPLAYS
- EQUIVALENT AC OUTPUT DRIVE FOR LIQUID-CRYSTAL DISPLAYS-NO EXTERNAL CAPACITOR REQUIRED
- VOLTAGE DOUBLING ACROSS DISPLAY [($V_{DD} - V_{EE}$) = 18V] RESULTS IN EFFECTIVE 36V (p-p) DRIVE ACROSS SELECTED DISPLAY SEGMENTS
- LOW-OR HIGH-OUTPUT LEVEL DC DRIVE FOR OTHER TYPES OF DISPLAYS
- ON-CHIP LOGIC-LEVEL CONVERSION FOR DIFFERENT INPUT AND OUTPUT-LEVEL SWINGS
- FULL DECODING OF ALL INPUT COMBINATIONS: "0 - 9, L, H, P, A-" AND BLANK POSITIONS
- INPUT CURRENT OF 100nA AT 18V AND 25°C FOR HCC DEVICE
- 100% TESTED FOR QUIESCENT CURRENT
- MEETS ALL REQUIREMENTS OF JEDEC TENTATIVE STANDARD N°. 13A, "STANDARD SPECIFICATIONS FOR DESCRIPTION OF "B" SERIES CMOS DEVICES"

DESCRIPTION

The **HCC4054B**, **HCC4055B** and **HCC4056B** (extended temperature range) and the **HCF4054B**, **HCF4055B** and **HCF4056B** (intermediate temperature range) are monolithic integrated circuits available in 16-lead dual in-line plastic or ceramic package and plastic micro package. The **HCC/HCF4055B** and **HCC/HCF4056B** types are single-digit BCD-to-7-segment decoder/driver circuits that provide level-shifting functions on the chip. This feature permits the BCD input-signal swings (V_{DD} to V_{SS}) to be the same as

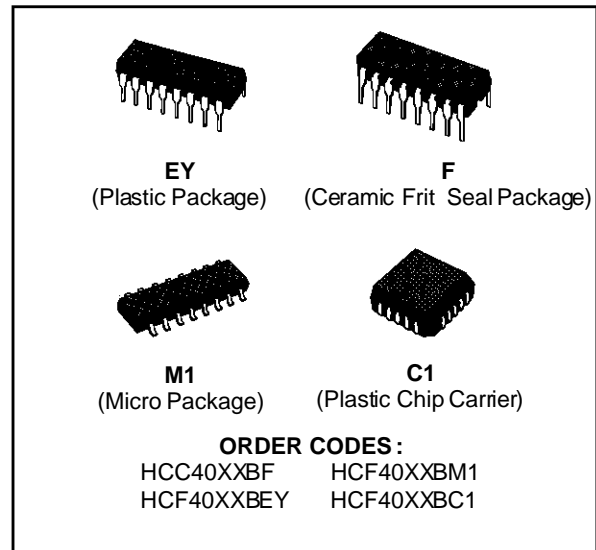

or different from the 7-segment output-signal swings (V_{DD} to V_{EE}). For example, the BCD input-signal swings (V_{DD} to V_{SS}) may be as low as 0 to -3V, whereas the output-display drive-signal swing (V_{DD} to V_{EE}) may be from 0 to -5V. If V_{DD} to V_{EE} exceeds 15V, V_{DD} to V_{SS} should be at least 4V. The 7-segment outputs are controlled by the DISPLAY-FREQUENCY (DF) input which causes the selected segment outputs to be low, high, or a square-wave output (for liquid-crystal displays). When the DF input is low the output segments will be high when selected by the BCD inputs. When the DF input is high, the output segments will be low when selected by the BCD inputs. When a square-wave is present at the DF input, the selected segments will have a square-wave output that is 180° out of phase with the DF input. Those segments which are not selected will have a square-wave output that is in phase with the input. DF square-wave repetition rates for liquid-crystal displays usually range from 30Hz (well above flicker rate) to 200Hz (well below the upper limit of the liquid-crystal frequency response). The **HCC/HCF4055B** provides a level-shifted high-amplitude DF output which is required for driving the common electrode in liquid-crystal displays. The **HCC/HCF4056B** provides a strobed-latch function at the BCD inputs. Decoding of all input combinations on the **HCC/HCF4055B** and **HCC/HCF4056B** provides displays of 0 to 9 as well

HCC/HCF4054B/55B/56B

as L, P, H, A, —, and a blank position. (see typical application for other letters). The **HCC/HCF4054B** provides level shifting similar to the **HCC/HCF4055B** and **HCC/HCF4056B** independently strobed latches, and common DF control on 4 signal lines. The **HCC/HCF4054B** is intended to provide drive-signal compatibility with the **HCC/HCF4055B** and **HCC/HCF4056B** 7-segment decoder types for the decimal point, colon, polarity, and similar display lines. A level-shifted high-amplitude DF output can be obtained from any **HCC/HCF4054B** output line by connecting the corresponding input and strobe lines to a low and high level, respectively. The **HCC/HCF4054B** may also be utilized for logic-level "up conversion" or "down conversion". For example, input-signal swings (V_{DD} to V_{SS}) from +5 to 0V can be converted to output-signal swings (V_{DD} to V_{EE}) of +5 to -5V. The level-shifted function on all three types permits the use of different input-and output-signal swings. The input swings from a low level of V_{SS} to a high level of V_{DD} while the output swings

from a low level of V_{EE} to the same high level of V_{DD} . Thus, the input and output swings can be selected independently of each other over a 3-to-18V range. V_{SS} may be connected to V_{EE} when no level-shifting function is required. For the **HCC/HCF 4054B** and **HCC/HCF 4056B**, data are transferred from input to output by placing a high voltage level at the strobe input. A low voltage level at the strobe input latches the data input and the corresponding output segments remain selected (or non-selected) while the strobe is low. Whenever the level-shifting function is required, the **HCC/HCF4055B** can be used by itself to drive a liquid-crystal display (fig. 10 and fig. 12). The **HCC/HCF4056B**, however, must be used together with a **HCC/HCF4054B** to provide the common DF output (fig. 14). The capability of extending the voltage swing on the negative end (this voltage cannot be extended on the positive end) can be used to advantage in the set-up of fig. 11. Fig. 9 is common to all three types.

PIN CONNECTIONS

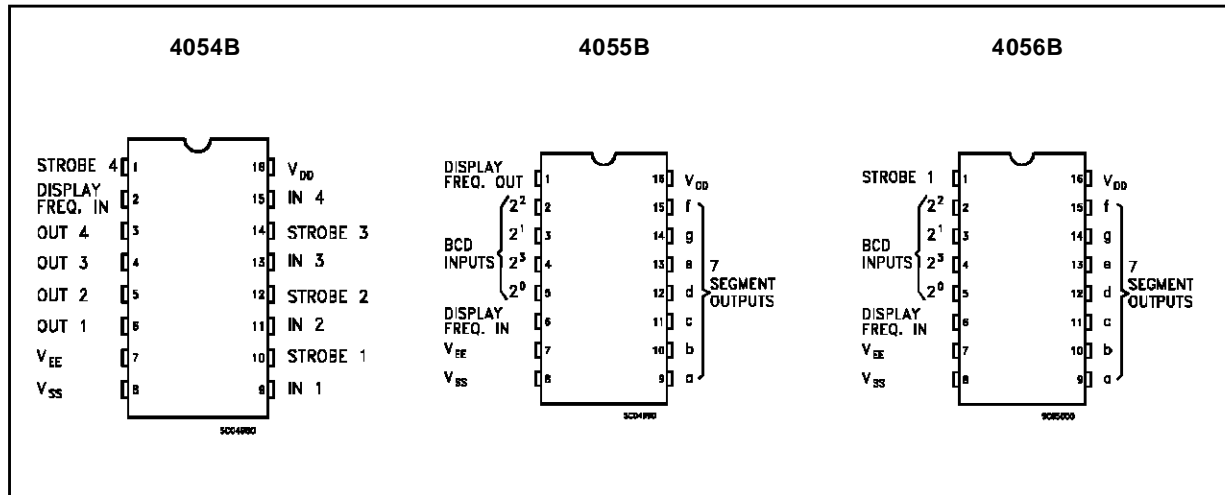

FUNCTIONAL DIAGRAMS

4054B

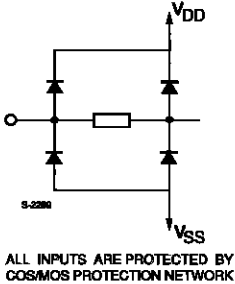

ALL INPUTS ARE PROTECTED BY COSMOS PROTECTION NETWORK

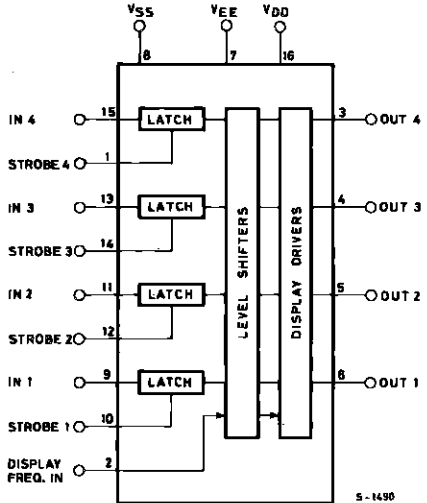

S-1490

4055B

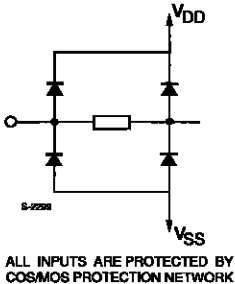

ALL INPUTS ARE PROTECTED BY COSMOS PROTECTION NETWORK

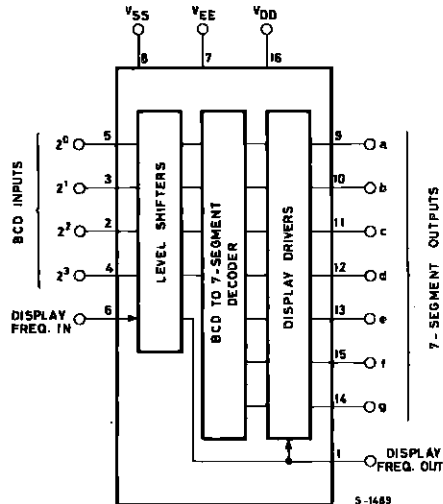

S-1489

4056B

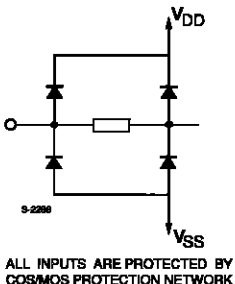

ALL INPUTS ARE PROTECTED BY COSMOS PROTECTION NETWORK

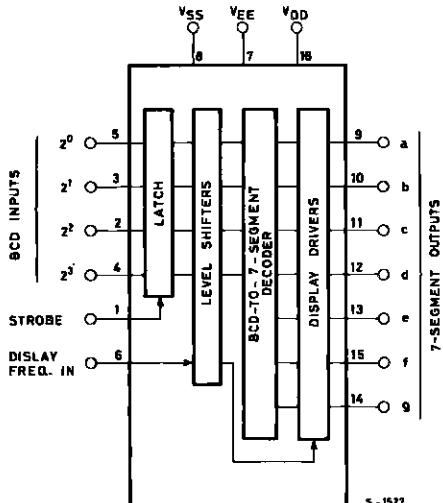

S-1527

HCC/HCF4054B/55B/56B

ABSOLUTE MAXIMUM RATINGS

Symbol	Parameter	Value	Unit
V _{DD} *	Supply Voltage : HCC Types HCF Types	- 0.5 to + 20	V
		- 0.5 to + 18	V
V _i	Input Voltage	- 0.5 to V _{DD} + 0.5	V
I _I	DC Input Current (any one input)	± 10	mA
P _{tot}	Total Power Dissipation (per package) Dissipation per Output Transistor for T _{op} = Full Package-temperature Range	200	mW
		100	mW
T _{op}	Operating Temperature : HCC Types HCF Types	- 55 to + 125	°C
		- 40 to + 85	°C
T _{stg}	Storage Temperature	- 65 to + 150	°C

Stresses above those listed under "Absolute Maximum Ratings" may cause permanent damage to the device. This is a stress rating only and functional operation of the device at these or any other conditions above those indicated in the operational sections of this specification is not implied. Exposure to absolute maximum rating conditions for external periods may affect device reliability.

* All voltage values are referred to V_{SS} pin voltage.

RECOMMENDED OPERATING CONDITIONS

Symbol	Parameter	Value	Unit
V _{DD}	Supply Voltage : HCC Types HCF Types	3 to 18	V
		3 to 15	V
V _I	Input Voltage	0 to V _{DD}	V
T _{op}	Operating Temperature : HCC Types HCF Types	- 55 to 125	°C
		- 40 to 85	°C

TRUTH TABLE

4055 B and 4056 B

Input Code				Output State							Display Character
2 ³	2 ²	2 ¹	2 ⁰	a	b	c	d	e	f	g	
0	0	0	0	1	1	1	1	1	1	0	0
0	0	0	1	0	1	1	0	0	0	0	1
0	0	1	0	1	1	0	1	1	0	1	2
0	0	1	1	1	1	1	1	0	0	1	3
0	1	0	0	0	1	1	0	0	1	1	4
0	1	0	1	1	0	1	1	0	1	1	5
0	1	1	0	1	0	1	1	1	1	1	6
0	1	1	1	1	1	1	0	0	0	0	7
1	0	0	0	1	1	1	1	1	1	1	8
1	0	0	1	1	1	1	1	0	1	1	9
1	0	1	0	0	0	0	1	1	1	0	L
1	0	1	1	0	1	1	0	1	1	1	H
1	1	0	0	1	1	0	0	1	1	1	P
1	1	0	1	1	1	1	0	1	1	1	A
1	1	1	0	0	0	0	0	0	0	1	-
1	1	1	1	0	0	0	0	0	0	0	BLANK

Data Setup Time and Strobe Pulse Duration.

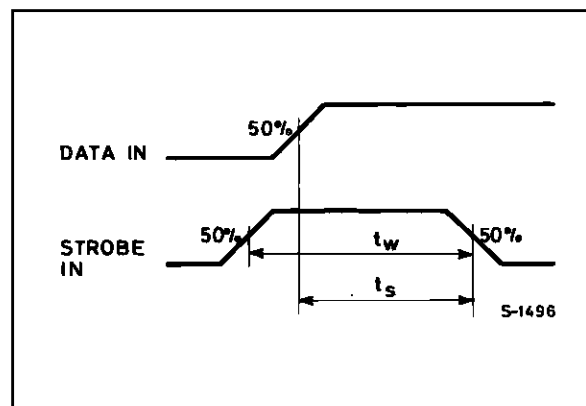

STATIC ELECTRICAL CHARACTERISTICS (over recommended operating conditions)

Symbol	Parameter		Test Conditions					Value						Unit	
			V _{EE} (V)	V _I (V)	V _O (V)	V _{SS} (V)	V _{DD} (V)	T _{Low} *		25°C			T _{High} *		
								Min.	Max.	Min.	Typ.	Max.	Min.		Max.
I _L	Quiescent Supply Current	HCC Types	- 5	0/5		0	5		5		0.04	5		150	μA
			0	0/10		0	10		10		0.04	10		300	
			0	0/15		0	15		20		0.04	20		600	
		HCF Types	0	0/20		0	20		100		0.08	100		3000	
			- 5	0/5		0	5		20		0.04	20		150	
			0	0/10		0	10		40		0.04	40		300	
V _{OH}	Output High Voltage		0	0/5		0	5	4.95		4.95			4.95	V	
			0	0/10		0	10	9.95		9.95			9.95		
			0	0/15		0	15	14.95		14.95			14.95		
V _{OL}	Output Low Voltage		0	5/0		0	5		0.05			0.05		V	
			0	10/0		0	10		0.05			0.05			
			0	15/0		0	15		0.05			0.05			
V _{IH}	Input High Voltage		- 5		0.5/4.5	0	5	3.5		3.5			3.5	V	
			0		1/9	0	10	7		7			7		
			0		1.5/13.5	0	15	11		11			11		
V _{IL}	Input Low Voltage		5		0.5/4.5	0	5		1.5			1.5		V	
			0		9/1	0	10		3			3			
			0		1.5/13.5	0	15		4			4			
I _{OH}	Output High Current	HCC Types	- 5	0/5	4.5	0	5	- 0.6		- 0.45	- 0.9		- 0.3	mA	
			0	0/10	9.5	0	10	- 0.6		- 0.45	- 0.9		- 0.3		
			0	0/15	13.5	0	15	- 1.9		- 1.5	- 3		- 1.1		
		HCF Types	- 5	0/5	4.5	0	5	- 0.47		- 0.38	- 0.9		- 0.28		
			0	0/10	9.5	0	10	- 0.47		- 0.38	- 0.9		- 0.28		
			0	0/15	13.5	0	15	- 1.58		- 1.27	- 3		- 0.95		
I _{OL}	Output Low Current	HCC Types	- 5	0/5	0.4	0	5	1.6		1.3	2.6		0.9	mA	
			0	0/10	0.5	0	10	1.6		1.3	2.6		0.9		
			0	0/15	1.5	0	15	4.2		3.4	6.8		2.4		
		HCF Types	- 5	0/5	0.4	0	5	1.37		1.1	2.6		0.82		
			0	0/10	0.5	0	10	1.37		1.1	2.6		0.82		
			0	0/15	1.5	0	15	3.62		2.9	6.8		2.17		
I _{IH} , I _{IL} **	Input Leakage Current	HCC Types	0	0/18		0	18		± 0.1		±10 ⁻⁵	± 0.1		± 1	μA
		HCF Types	0	0/15		0	15		± 0.3		±10 ⁻⁵	± 0.3		± 1	μA
C _I **	Input Capacitance									5	7.5			pF	

* T_{Low} = - 55°C for HCC device : - 40°C for HCF device.

* T_{High} = 125°C for HCC device : + 85°C for HCF device.

The Noise Margin for both "1" and "0" level is : 1V min. with V_{DD} = 5V, 2V min. with V_{DD} = 10V, 2.5 V min. with V_{DD} = 15V.

** Any input

HCC/HCF4054B/55B/56B

DYNAMIC ELECTRICAL CHARACTERISTICS ($T_{amb} = 25^{\circ}\text{C}$, $C_L = 50\text{pF}$, $R_L = 200\text{k}\Omega$, typical temperature coefficient for all V_{DD} values is $0.3\%/^{\circ}\text{C}$, all input rise and fall times = 20ns)

Symbol	Parameter	Test Conditions			Types						Unit
		V_{EE} (V)	V_{SS} (V)	V_{DD} (V)	4054B			4055B, 4056B			
					Min.	Typ.	Max.	Min.	Typ.	Max.	
t_{PHL}, t_{PLH}	Propagation Delay Time (any input to any output)	-5	0	5		400	800		650	1300	ns
		0	0	10		340	680		575	1150	
		0	0	15		250	500		375	750	
t_{THL}, t_{TLH}	Transition Time (any output)	-5	0	5		100	200		100	200	ns
		0	0	10		100	200		100	200	
		0	0	15		75	150		75	150	
t_{setup}^*	Data Setup Time	-5	0	5	220	110		220	110		ns
		0	0	10	100	50		100	50		
		0	0	15	70	35		70	35		
t_W^*	Strobe Pulse Width	-5	0	5	220	110		220	110		ns
		0	0	10	100	50		100	50		
		0	0	15	70	35		70	35		

* HCC/HCF4054B and HCC/HCF4056B only.

Figure 1 : Typical Output Low (sink) Current Characteristics.

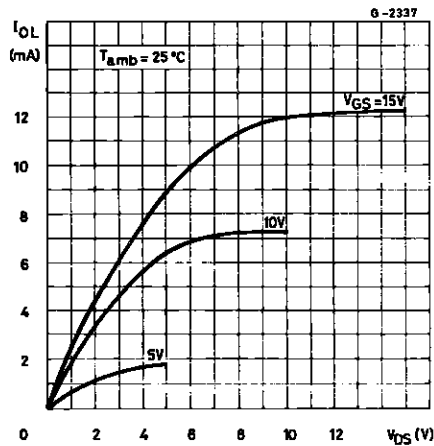

Figure 2 : Minimum Output High (source) Current Characteristics.

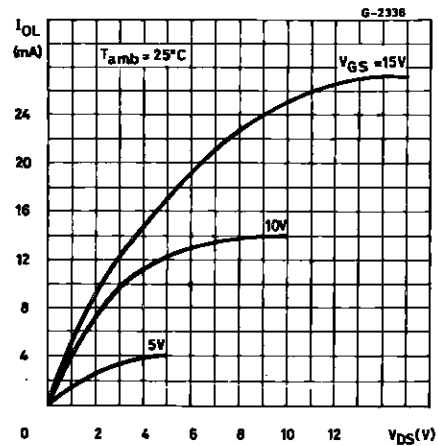

Figure 3 : Typical Output High (source) Current Characteristics.

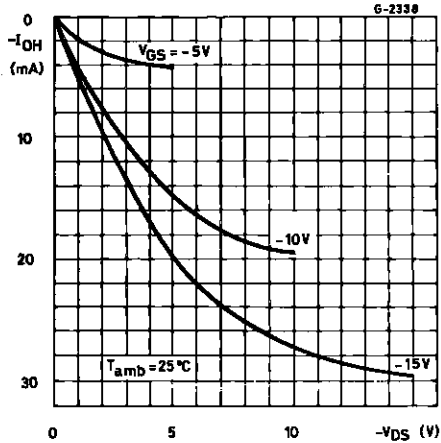

Figure 4 : Minimum Output (source) Current Characteristics.

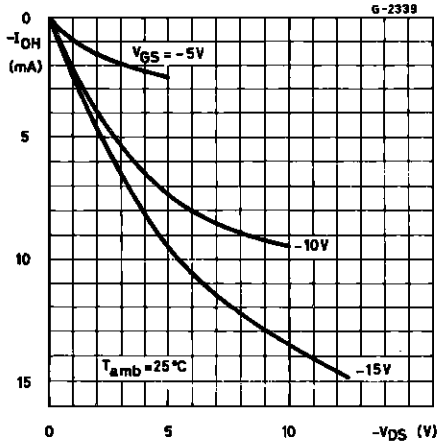

Figure 5 : Typical Propagation Delay Time vs. Load Capacitance (for 4054B).

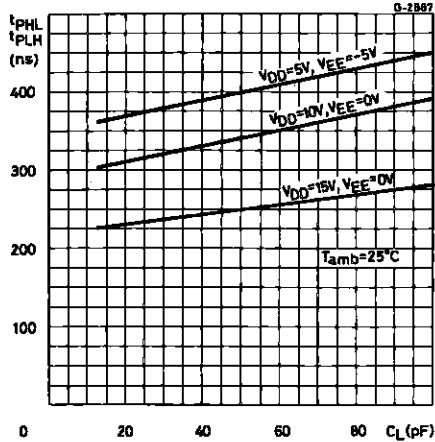

Figure 6 : Typical Propagation Delay Time vs. Load Capacitance (for 4055B and 4056B).

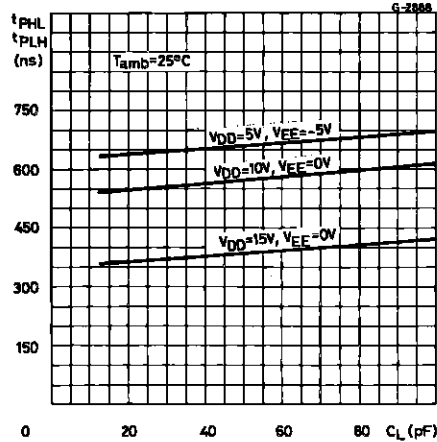

Figure 7 : Typical Transition Time vs. Load Capacitance.

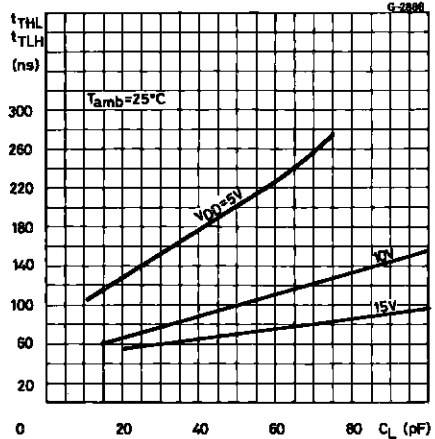
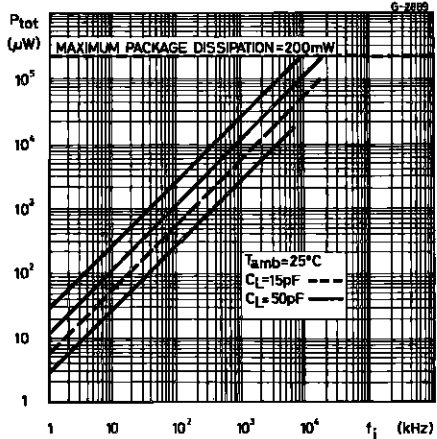

Figure 8 : Typical Dynamic Power Dissipation vs. Frequency.



TYPICAL APPLICATIONS

Figure 9 : Display-driver Circuit for one Segment Line and Waveforms.

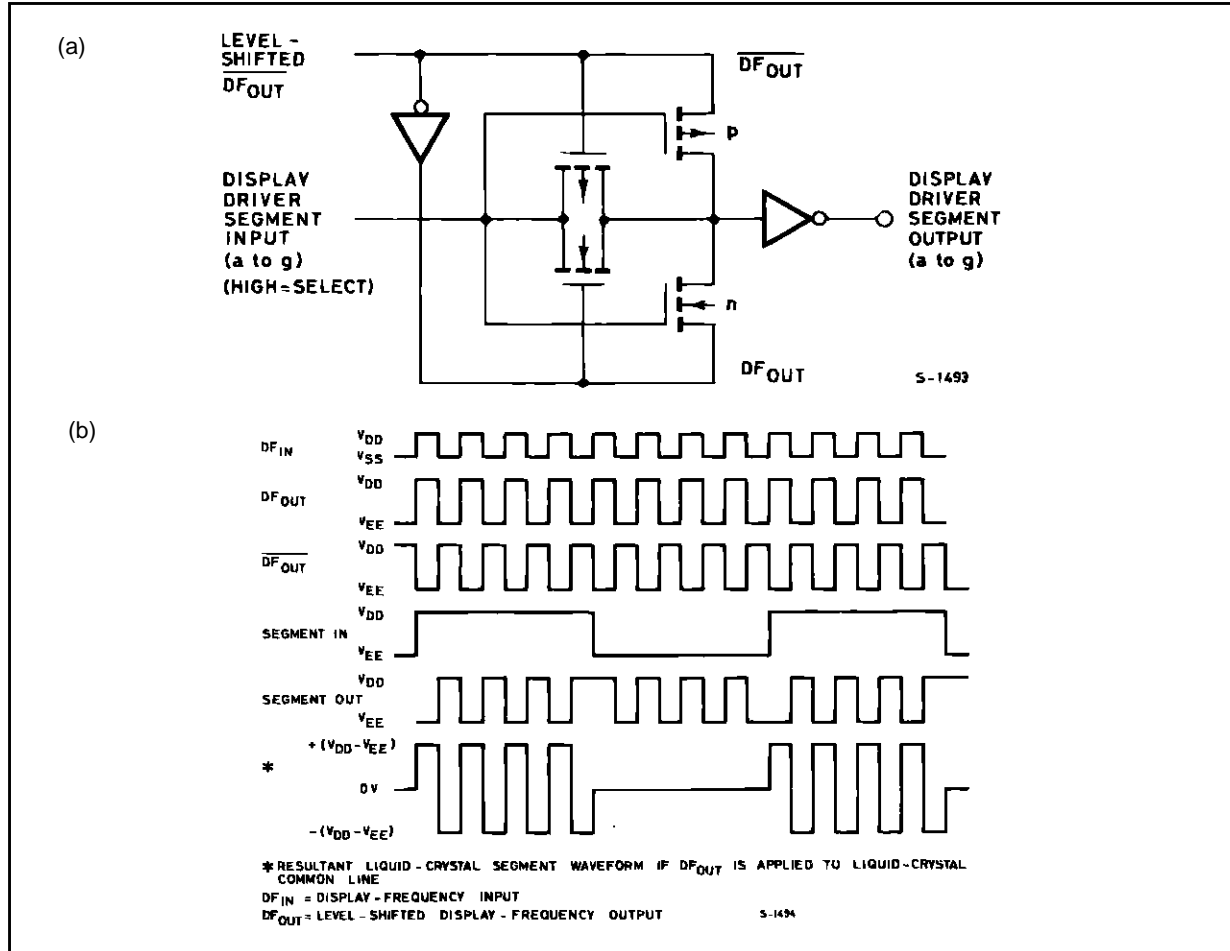
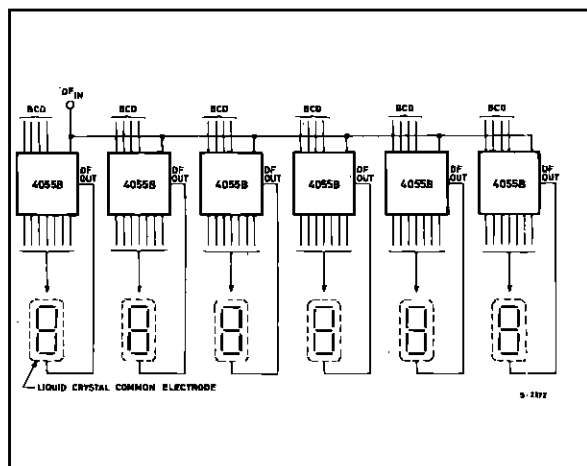
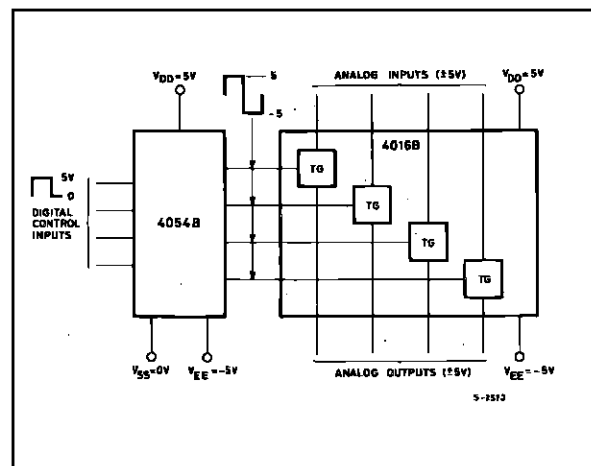

Figure 10 : Clock Display.



$V_{DD} = 0V$, $V_{SS} = -5V$, $V_{EE} = -15V$, $F_{IN} = 30$ Hz square wave.

Figure 11 : Digital (0 to +5V) to bidirectional Analog Control (+5 to -5V) Level Shifter.



TYPICAL APPLICATIONS (continued)

Figure 12 : Single-digit Liquid Crystal Display.

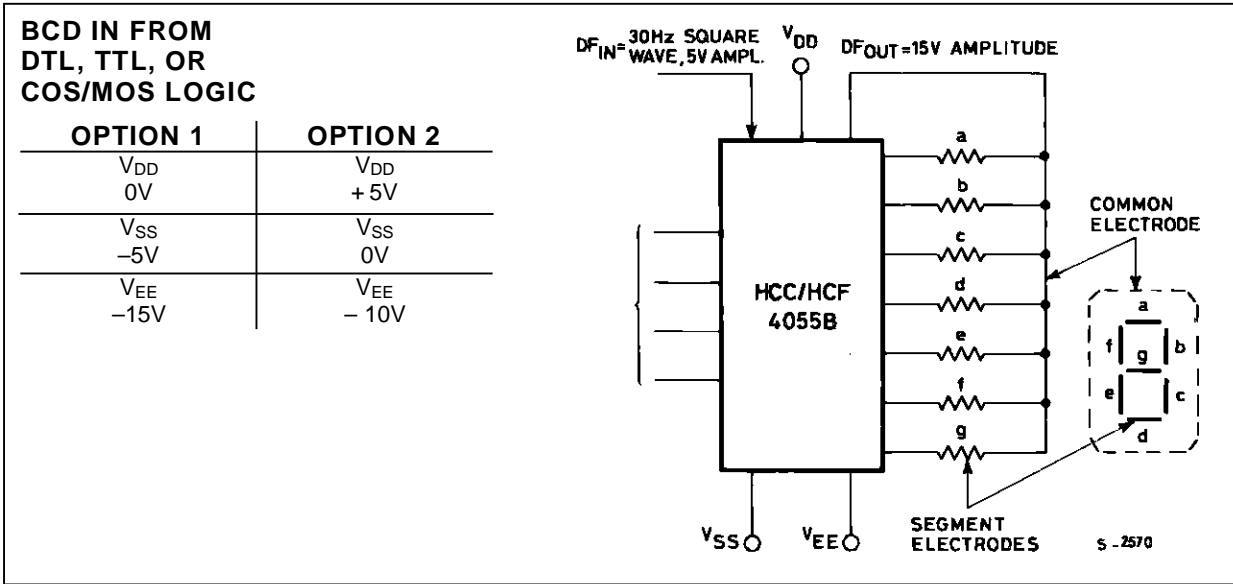
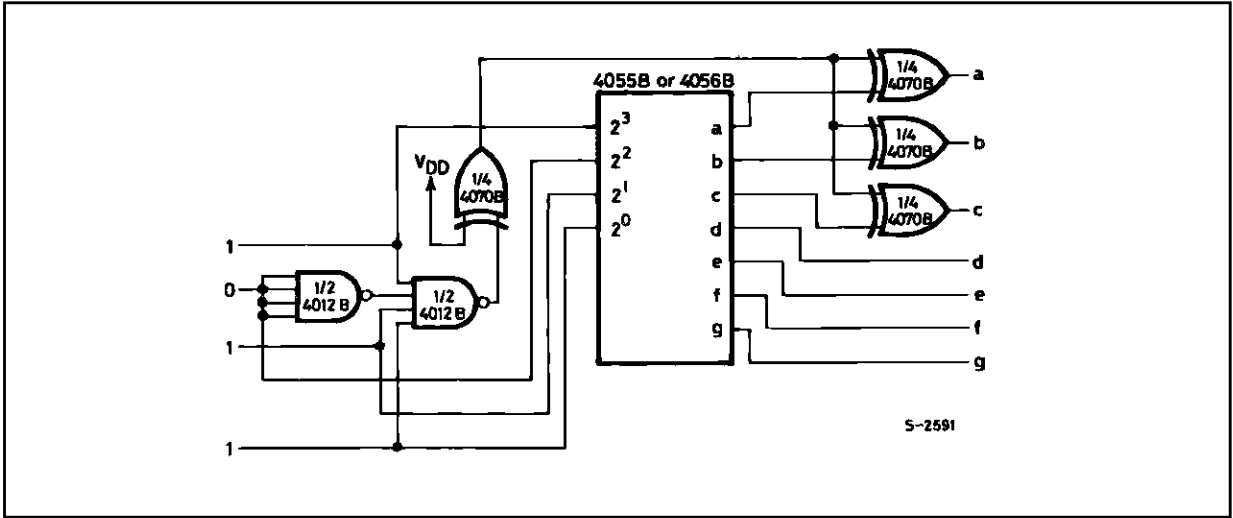
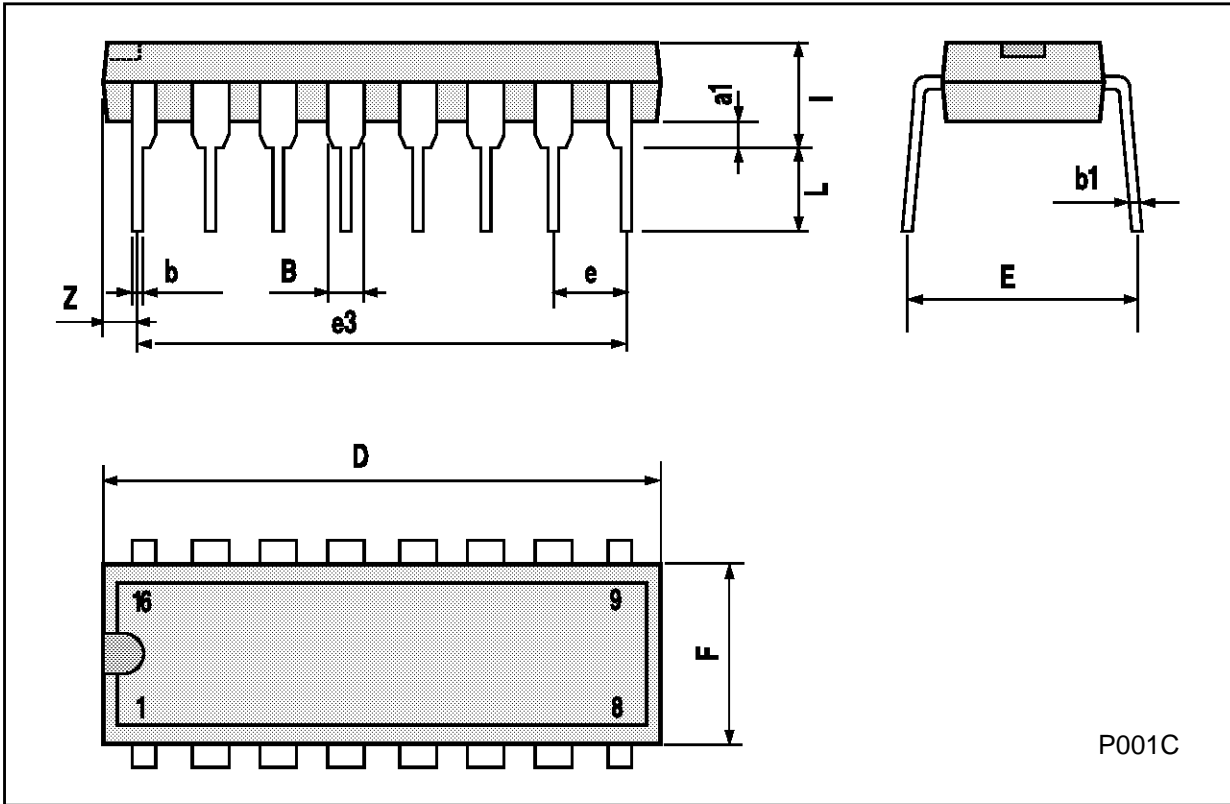

Figure 13 : Conversion of "H" Display to "F" Display.



Plastic DIP16 (0.25) MECHANICAL DATA

DIM.	mm			inch		
	MIN.	TYP.	MAX.	MIN.	TYP.	MAX.
a1	0.51			0.020		
B	0.77		1.65	0.030		0.065
b		0.5			0.020	
b1		0.25			0.010	
D			20			0.787
E		8.5			0.335	
e		2.54			0.100	
e3		17.78			0.700	
F			7.1			0.280
I			5.1			0.201
L		3.3			0.130	
Z			1.27			0.050



Ceramic DIP16/1 MECHANICAL DATA

DIM.	mm			inch		
	MIN.	TYP.	MAX.	MIN.	TYP.	MAX.
A			20			0.787
B			7			0.276
D		3.3			0.130	
E	0.38			0.015		
e3		17.78			0.700	
F	2.29		2.79	0.090		0.110
G	0.4		0.55	0.016		0.022
H	1.17		1.52	0.046		0.060
L	0.22		0.31	0.009		0.012
M	0.51		1.27	0.020		0.050
N			10.3			0.406
P	7.8		8.05	0.307		0.317
Q			5.08			0.200

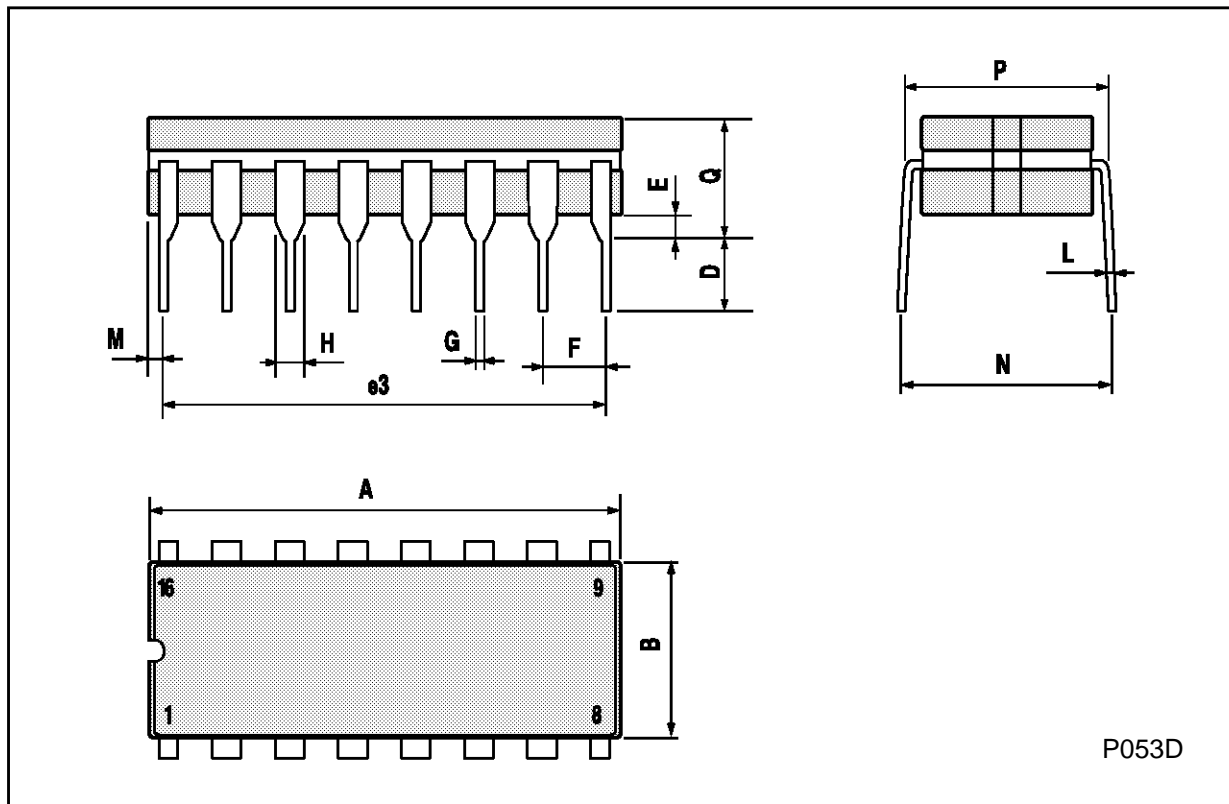

SO16 (Narrow) MECHANICAL DATA

DIM.	mm			inch		
	MIN.	TYP.	MAX.	MIN.	TYP.	MAX.
A			1.75			0.068
a1	0.1		0.2	0.004		0.007
a2			1.65			0.064
b	0.35		0.46	0.013		0.018
b1	0.19		0.25	0.007		0.010
C		0.5			0.019	
c1	45° (typ.)					
D	9.8		10	0.385		0.393
E	5.8		6.2	0.228		0.244
e		1.27			0.050	
e3		8.89			0.350	
F	3.8		4.0	0.149		0.157
G	4.6		5.3	0.181		0.208
L	0.5		1.27	0.019		0.050
M			0.62			0.024
S	8° (max.)					

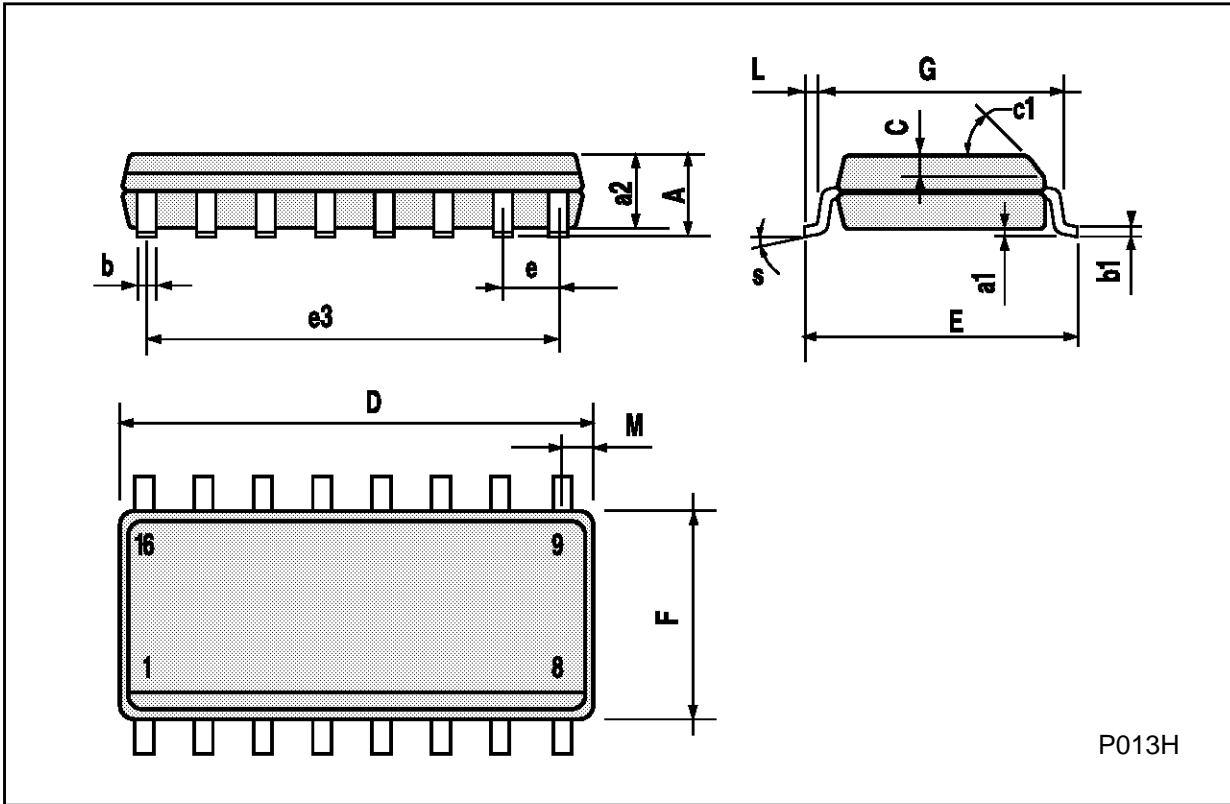

P013H

PLCC20 MECHANICAL DATA

DIM.	mm			inch		
	MIN.	TYP.	MAX.	MIN.	TYP.	MAX.
A	9.78		10.03	0.385		0.395
B	8.89		9.04	0.350		0.356
D	4.2		4.57	0.165		0.180
d1		2.54			0.100	
d2		0.56			0.022	
E	7.37		8.38	0.290		0.330
e		1.27			0.050	
e3		5.08			0.200	
F		0.38			0.015	
G			0.101			0.004
M		1.27			0.050	
M1		1.14			0.045	

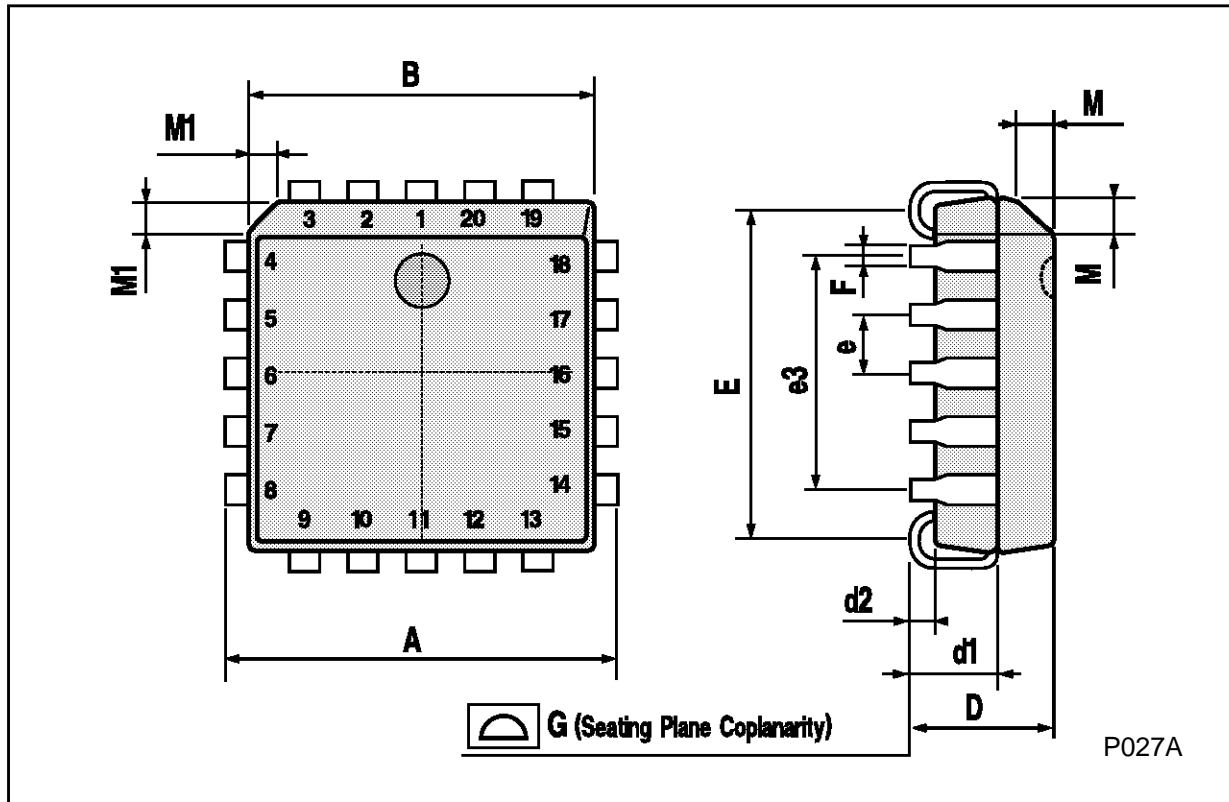

Information furnished is believed to be accurate and reliable. However, SGS-THOMSON Microelectronics assumes no responsibility for the consequences of use of such information nor for any infringement of patents or other rights of third parties which may result from its use. No license is granted by implication or otherwise under any patent or patent rights of SGS-THOMSON Microelectronics. Specifications mentioned in this publication are subject to change without notice. This publication supersedes and replaces all information previously supplied. SGS-THOMSON Microelectronics products are not authorized for use as critical components in life support devices or systems without express written approval of SGS-THOMSON Microelectronics.

© 1994 SGS-THOMSON Microelectronics - All Rights Reserved

SGS-THOMSON Microelectronics GROUP OF COMPANIES

Australia - Brazil - France - Germany - Hong Kong - Italy - Japan - Korea - Malaysia - Malta - Morocco - The Netherlands -
Singapore - Spain - Sweden - Switzerland - Taiwan - Thailand - United Kingdom - U.S.A