

2.4GHz RF/IF Converter and Synthesizer



The HFA3683A is a monolithic SiGe half-duplex RF/IF transceiver designed to operate in the 2.4GHz ISM band. The receive chain features

a low noise, gain selectable amplifier (LNA) followed by a down-converter mixer. An up-converter mixer and a high performance preamplifier compose the transmit chain. The remaining circuitry comprises a high frequency Phase Locked Loop (PLL) synthesizer with a three wire programmable interface for local oscillator applications.

A reduced filter count is realized by multiplexing the receive and transmit IF paths and by sharing a common differential matching network. Furthermore, both transmit and receive RF amplifiers can be directly connected to mixers. The inherent image rejection of both the transmit and receive functions allow this economic advantage.

The HFA3683A is housed in a 64 lead TQFP package well suited for PCMCIA board applications.

Ordering Information

PART NUMBER	TEMP. RANGE (°C)	PACKAGE	PKG. NO.
HFA3683AIN	-40 to 85	64 Ld TQFP	Q64.10x10
HFA3683AIN96	-40 to 85	Tape and Reel	

Simplified Block Diagram

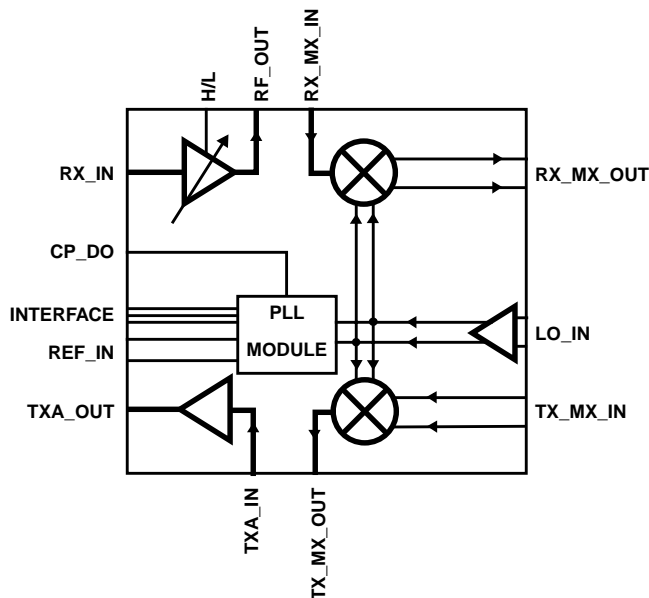

Features

- Highly Integrated
- Multiplexed RX/TX IF Path Utilizes Single IF Filter
- Programmable Synthesizer
- Gain Selectable LNA
- Power Management/Standby Mode
- Single Supply 2.7V to 3.3V Operation

Cascaded LNA/Mixer (High Gain)

- Gain25dB
- SSB Noise Figure. 3.7dB
- Input IP3. -13dBm
- IF Frequency 280MHz to 600MHz

Cascaded LNA/Mixer (Low Gain)

- Gain-5dB
- Input P1dB +2.5dBm
- IF Frequency 280MHz to 600MHz

Cascaded Mixer/Preamplifier

- Transmit Cascaded Mixer/Preamplifier Gain25dB
- SSB Noise Figure.10dB
- Output P1dB. 4dBm
- IF Frequency 280MHz to 600MHz

Applications

- IEEE802.11 1MBPS and 2MBPS Standard
- Systems Targeting IEEE802.11, 11MBPS Standard
- Wireless Local Area Networks
- PCMCIA Wireless Transceivers
- ISM Systems
- TDMA Packet Protocol Radios

Pinout

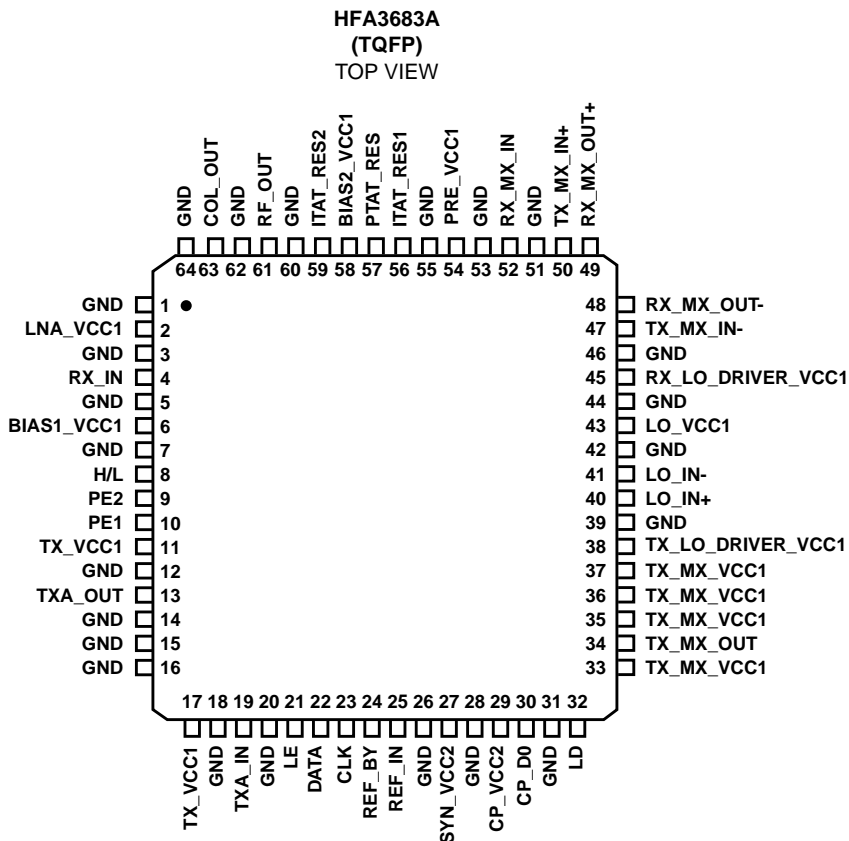

Pin Descriptions

PIN	NAME	DESCRIPTION
2	LNA_VCC1	Low Noise Amplifier Positive Power Supply.
4	RX_IN	Low Noise Amplifier RF Input, internally DC coupled and requires an external blocking capacitor. A shunt capacitor to ground matches the input for return loss and optimum NF.
6	BIAS1_VCC1	Bias Positive Power Supply for the LNA and Preamplifier.
8	H/L	High or Low Gain Select, controls the LNA high and low gain modes.
9	PE2	This pin along with pin PE1 and bit M(0) of PLL_PE determine which of various operational modes will be active. Please refer to the Power Enable Truth Table.
10	PE1	This pin along with pin PE2 and bit M(0) of PLL_PE determine which of various operational modes will be active. Please refer to the Power Enable Truth Table.
11	TX_VCC1	Transmit Amplifier Positive Power Supply, requires a high quality decoupling capacitor and a short return path.
13	TXA_OUT	Transmit Amplifier Output, internally matched to 50Ω, requires an external DC blocking capacitor.
17	TX_VCC1	Transmit Amplifier Positive Power Supply.
19	TXA_IN	Transmit Amplifier Input, internally AC coupled.
21	LE	Synthesizer Latch Enable, the serial interface is active when LE is low and the serial data is latched into defined registers on the rising edge of LE.
22	DATA	Synthesizer Serial Data Input, clocked in on the rising edge of the serial clock, MSB first.
23	CLK	Synthesizer Clock, DATA is clocked in on the rising edge of the serial clock, MSB first.
24	REF_BY	Synthesizer Reference Frequency Input Bypass, internally DC coupled and requires an external bypass to ground when REF_IN is used as a Single Ended input, alternatively, requires an external AC coupling capacitor when used as a differential input.
25	REF_IN	Synthesizer Reference Frequency Input, internally DC coupled and requires an external AC coupling capacitor.

Pin Descriptions (Continued)

PIN	NAME	DESCRIPTION
27	SYN_VCC2	Synthesizer Positive Power Supply.
29	CP_VCC2	Synthesizer Charge Pump Positive Power Supply.
30	CP_DO	Synthesizer Charge Pump Output, feeds the PLL loop filter.
32	LD	Synthesizer Lock Detect Output.
33	TX_MX_VCC1	Transmit Mixer Positive Power Supply.
34	TX_MX_OUT	Transmit Mixer RF output, internal AC coupled and internally matched to 50Ω.
35	TX_MX_VCC1	Transmit Mixer Positive Power Supply.
36	TX_MX_VCC1	Transmit Mixer Positive Power Supply.
37	TX_MX_VCC1	Transmit Mixer Positive Power Supply.
38	TX_LO_Driver_VCC1	Transmit LO Driver Positive Power Supply.
40	LO_IN+	Local Oscillator Positive Input, internally AC coupled, internally matched to 50Ω when the LO is driven single ended and the LO_IN- is grounded.
41	LO_IN-	Local Oscillator Negative Input, internally AC coupled, differential or single ended capability, ground externally for single ended operation.
43	LO_VCC1	LO Buffer Positive Power Supply.
45	RX_LO_DRIVER_VCC1	Receiver LO Driver Positive Power Supply.
47	TX_MX_IN-	Transmit Mixer Negative Input, internally DC coupled, high impedance input. Designed to share a common IF matching network/IF SAW filter with the receive mixer. Care should be exercised regarding the PC board layout to avoid interference and noise pickup. Layout symmetry and management of PC board parasitics is also critical for maximizing the bandwidth of the IF matching network.
48	RX_MX_OUT-	Receive Mixer Negative Output, open collector, high impedance output. Designed to share a common IF matching network/IF SAW filter with the transmit mixer. Care should be exercised regarding the PC board layout to avoid interference and noise pickup. Layout symmetry and management of PC board parasitics is also critical for maximizing the bandwidth of the IF matching network.
49	RX_MX_OUT+	Receive Mixer Positive Output, open collector, high impedance output. Designed to share a common IF matching network/IF SAW filter with the transmit mixer. Care should be exercised regarding the PC board layout to avoid interference and noise pickup. Layout symmetry and management of PC board parasitics is also critical for maximizing the bandwidth of the IF matching network.
50	TX_MX_IN+	Transmit Mixer Positive Input, internally DC coupled, high impedance input. Designed to share a common IF matching network/IF SAW filter with the receive mixer. Care should be exercised regarding the PC board layout to avoid interference and noise pickup. Layout symmetry and management of PC board parasitics is also critical for maximizing the bandwidth of the IF matching network.
52	RX_MX_IN	Receive Mixer RF Input, internally DC coupled and requires external AC coupling as well as RF matching. The recommend network consists of a 3.3pF series capacitor followed by a small series inductance of 1.4nH and then a 1.2nH shunt inductor. The series inductance is best implemented on the PC board using a narrow transmission line inductor.
54	PRE_VCC1	PLL Prescaler Positive Power Supply.
56	ITAT_RES1	Connection to external resistor sets the receive and transmit mixers tail currents, independent of Absolute Temperature.
57	PTAT_RES	Connection to external resistor sets the receive and transmit mixers tail currents, proportional to Absolute Temperature.
58	BIAS2_VCC1	Bias Positive Power Supply for the receive and transmit mixers.
59	ITAT_RES2	Connection to external resistor sets the LNA and Preamplifier bias currents, independent of Absolute Temperature.
61	RF_OUT	Low Noise Amplifier RF Output, internally AC coupled and internally matched to 50Ω.
63	COL_OUT	LNA Collector Output, requires a bypass capacitance which is resonant with the PC board parasitics. A small resistance (20Ω) in series with the main PC board VCC buss is recommended to provide isolation from other VCC bypass capacitors. This ensures the image rejection performance of the LNA is maintained.
All Others	GND	Circuit Ground Pins (Quantity 23 each).

Absolute Maximum Ratings

Supply Voltage	3.6V
Voltage on Any Other Pin	-0.3 to V _{CC} +0.3V
V _{CC} to V _{CC} Decouple	-0.3 to +0.3V
Any GND to GND	-0.3 to +0.3V
Pins 4, 19, 52, 56, 57 and 59	0.3 to +0.6V

Thermal Information

Thermal Resistance (Typical, Note 1)	θ_{JA} (°C/W)
TQFP Package	65
Maximum Junction Temperature (Plastic Package)	150°C
Maximum Storage Temperature Range	-65°C to 150°C
Maximum Lead Temperature (Soldering 10s)	300°C
(TQFP - Lead Tips Only)	

Operating Conditions

Temperature Range	-40 to 85°C
Supply Voltage Range	2.7V to 3.3V

CAUTION: Stresses above those listed in "Absolute Maximum Ratings" may cause permanent damage to the device. This is a stress only rating and operation of the device at these or any other conditions above those indicated in the operational sections of this specification is not implied.

NOTE:

1. θ_{JA} is measured with the component mounted on an evaluation PC board in free air.

General Electrical Specifications

PARAMETER	TEMP. (°C)	MIN	TYP	MAX	UNITS
Supply Voltage	Full	2.7	-	3.3	V
Receive Total Supply Current (LNA in High Gain)	25	-	33	38	mA
Receive Total Supply Current (LNA in Low Gain)	25	-	27	32	mA
Transmit Total Supply Current*	25	-	40	45	mA
Standby Total Supply Current (PLL and LO Buffers Active)	25	-	6	8	mA
TX/RX Power Down Supply Current	Full	-	10	100	µA
TX/RX/Power Down Time (Note 2)	Full	-	1	10	µs
RX/TX, TX/RX Switching Time (Note 2)	Full	-	0.2	1	µs
CMOS Low Level Input Voltage (CLK, DATA, LE) (Note 3)	Full	-	-	0.3V _{DD}	V
CMOS High Level Input Voltage (CLK, DATA, LE) (Note 3)	Full	0.7V _{DD}	-	3.6	V
CMOS High or Low Level Input Current (CLK, DATA, LE)	Full	-3.0	-	+3.0	µA
Control Logic Low Level Input Voltage (H/L, PE1, PE2) (Note 4)	Full	-0.3	-	0.5	V
Control Logic High Level Input Voltage (H/L, PE1, PE2) (Notes 3 and 4)	Full	V _{DD} -0.5	-	-	V

NOTES:

2. TX/RX/TX switching time and power Down/Up time are dependent on external components.
3. V_{DD} is the supply voltage of external Control sources.
4. These three pins H/L, PE1 and PE2 are not connected to CMOS circuitry and have different thresholds from all other control pins.

Cascaded LNA/Mixer AC Electrical Specifications Assumes a direct connection between the LNA and Mixer, IF = 374MHz, LO = 2075MHz at -6dBm, V_{CC} = 2.7 Unless Otherwise Specified

PARAMETER	TEST CONDITIONS	TEMP. (°C)	MIN	TYP	MAX	UNITS
RF Frequency Range		Full	2400	-	2500	MHz
IF Frequency Range		Full	280	374	600	MHz
LO Frequency Range		Full	1800	-	2220	MHz
LO Input Drive Level	Single End or Differential	Full	-10	-6	0	dBm
Power/Voltage Gain	High Gain Mode	Full	21.5	25	29	dB
Noise Figure SSB		Full	-	3.7	5.0	dB
Input IP3		Full	-17.5	-11	-	dBm
Input P1dB		Full	-27.5	-22	-	dBm

HFA3683A

Cascaded LNA/Mixer AC Electrical Specifications Assumes a direct connection between the LNA and Mixer, IF = 374MHz, LO = 2075MHz at -6dBm, V_{CC} = 2.7 Unless Otherwise Specified **(Continued)**

PARAMETER	TEST CONDITIONS	TEMP. (°C)	MIN	TYP	MAX	UNITS
Power/Voltage Gain	Low Gain Mode	Full	-9	-5	-1	dB
Noise Figure		25	-	25	-	dB
Output IM3 at -12dBm Input Tones		Full	-42	-40.5	-40	dBc
Input P1dB		Full	-1	+2.5	-	dBm
LNA Input 50Ω VSWR	High Gain Mode	25	1.28	1.65:1	2.0:1	-
	Low Gain Mode	25	1.1:1	1.3:1	2.0:1	-
LO 50Ω VSWR	LO = Single End	25	1.4:1	1.4:1	2.0:1	-
Differential IF Output Load	Shared with TX	25	-	200	-	Ω
IF Output Capacitance (Single Ended)		25	-	1.2	-	pF
IF Output Resistance (Single Ended)		25	-	5.5	-	kΩ
LO to Mixer RF Feedthrough (Uncascaded)		25	-	-50	-20	dBm
LO to LNA Input Feedthrough (Cascaded, no Filter)		25	-69	-60	-50	dBm
Gain Switching Speed at Full Scale - High to Low	±1dB settling	Full	-	0.03	0.1	μs
Gain Switching Speed at Full Scale - Low to High	±1dB settling	Full	-	0.25	0.3	μs
Image Rejection	With Matching Network	25	-	14	-	dB

Cascaded Transmit Mixer AC Electrical Specifications Assumes a direct connection between the Mixer and Preamplifier, F = 374MHz, LO = 2075MHz at -6dBm, V_{CC} = 2.7 Unless Otherwise Specified.

PARAMETER	TEST CONDITIONS	TEMP. (°C)	MIN	TYP	MAX	UNITS
RF Frequency Range		Full	2400	-	2500	MHz
IF Frequency Range		Full	280	374	600	MHz
LO Frequency Range		Full	1800	-	2220	MHz
Power Conversion Gain	200Ω In, 50Ω Out	Full	21	25	29	dB
SSB Noise Figure		Full	-	10	15	dB
Output IP3		Full	+12	+14	+20	dBm
Output P1dB		Full	+2	+4	+9	dBm
LO Input Drive Level	Same as RX	Full	-10	-6	0	dBm
LO to Transmit Mixer RF Feedthrough (Uncascaded)		25	-	-37	-20	dBm
LO to Transmit Amp. Output Feedthrough (Uncascaded)		25	-	-45	-30	dBm
LO to Transmit Amp. Output Feedthrough (Cascaded, no Filter)		25	-	-15	-5	dBm
Preamplifier Output 50Ω VSWR		25	-	2.3:1	3.0:1	-
LO 50Ω VSWR	LO = Single End	25	-	1.4:1	2.0:1	-
Differential IF Input Load	Shared with RX	25	-	200	-	Ω
IF Input Capacitance (Single Ended)		25	-	1.1	-	pF
IF Input Resistance (Single Ended)		25	-	0.7	-	kΩ

Phase Lock Loop Electrical Specifications (See Notes 5 through 13)

PARAMETER	TEST CONDITIONS	TEMP. (°C)	MIN	TYP	MAX	UNITS
Operating LO Frequency (32/33 Prescaler)		Full	1800	-	2220	MHz
Operating LO Frequency (64/65 Prescaler)		Full	1800	-	3500	MHz
Reference Oscillator Frequency		Full	-	-	50	MHz
Selectable Prescaler Ratios (P)		Full	32/33	-	64/65	-
Swallow Counter Divide Ratio (A Counter)		Full	0	-	127	-
Programmable Counter Divide Ratio (B Counter)		Full	3	-	2047	-
Reference Counter Divide Ratio (R Counter)		Full	3	-	32767	-
Reference Oscillator Sensitivity, Single or Differential Sine Inputs		Full	0.5	-	V _{CC}	V _{PP}
Reference Oscillator Sensitivity, CMOS Inputs, Single Ended or Complimentary		Full	-	CMOS	-	Note 7
Reference Oscillator Duty Cycle	CMOS Inputs	25	40	-	60	%
Charge Pump Sink/Source Current/Tolerance	250µA Selection ±25%	25	0.18	0.25	0.32	mA
Charge Pump Sink/Source Current/Tolerance	500µA Selection ±25%	25	0.375	0.50	0.625	mA
Charge Pump Sink/Source Current/Tolerance	750µA Selection ±25%	25	0.56	0.75	0.94	mA
Charge Pump Sink/Source Current/Tolerance	1mA Selection ±25%	25	0.75	1.0	1.25	mA
Charge Pump Sink/Source Mismatch		Full	-	-	15	%
Charge Pump Output Compliance		Full	0.5	-	V _{CC2} -0.5	V
Charge Pump Supply Voltage		Full	2.7	-	3.6	V
Serial Interface Clock Width	High Level t _{CWH}	Full	20	-	-	ns
	Low Level t _{CWL}	Full	20	-	-	ns
Serial Interface Data/Clk Set-Up Time t _{CS}		Full	20	-	-	ns
Serial Interface Data/Clk Hold Time t _{CH}		Full	10	-	-	ns
Serial Interface Clk/LE Set-Up Time t _{ES}		Full	20	-	-	ns
Serial Interface LE Pulse Width t _{EW}		Full	20	-	-	ns

NOTES:

- The Serial data is clocked on the Rising Edge of the serial clock, MSB first. The serial Interface is active when LE is LOW. The serial Data is latched into defined registers on the rising edge of LE.
- As long as power is applied, all register settings will remain stored, including the power down state. The system may then come in and out of the power down state without requiring the registers to be rewritten.
- CMOS Reference Oscillator input levels are given in the General Electrical Specification section.

POWER ENABLE TRUTH TABLE

PE1	PE2	PLL_PE (SERIAL BUS)	STATUS
0	0	1	Power Down State, Registers in Save Mode, Inactive PLL, Active Serial Interface
1	1	1	Receive State, Active PLL
1	0	1	Transmit State, Active PLL
0	1	1	Inactive Transmit and Receive States, Active PLL, Active Serial Interface
X	X	0	Inactive PLL, Disabled PLL Registers, Active Serial Interface

NOTE:

- PLL_PE is controlled via the serial interface, and can be used to disable the synthesizer. The actual synthesizer control is a logic AND function of PLL_PE and the result of the logic OR function of PE1 and PE2. PE1 and PE2 directly control the power enable functionality of the LO buffers.

PLL Synthesizer Table

SERIAL BITS	REGISTER DEFINITION																				
	LSB	1	2	3	4	5	6	7	8	9	10	11	12	13	14	15	16	17	18	19	MSB
R Counter	0	0	R(0)	R(1)	R(2)	R(3)	R(4)	R(5)	R(6)	R(7)	R(8)	R(9)	R(10)	R(11)	R(12)	R(13)	R(14)	X (Don't Care)			
A/B Counter	0	1	A(0)	A(1)	A(2)	A(3)	A(4)	A(5)	A(6)	B(0)	B(1)	B(2)	B(3)	B(4)	B(5)	B(6)	B(7)	B(8)	B(9)	B(10)	
Operational Mode	1	0	M(0)	0	M(2)	M(3)	M(4)	M(5)	M(6)	M(7)	M(8)	0	0	0	0	M(13)	M(14)	M(15)	X	X	

Reference Frequency Counter/Divider

BIT	DESCRIPTION
R(0-14)	Least significant bit R(0) to most significant bit R(14) of the divide by R counter. The Reference signal frequency is divided down by this counter and is compared with a divided LO by a phase detector.

LO Frequency Counters/Dividers

BIT	DESCRIPTION
A(0-6)	Least significant bit A(0) to most significant bit A(6) of a 7-bit Swallow counter and LSB B(0) to MSB B(10) of the 11-bit divider. The LO frequency is divided down by $[P*B+A]$, where P is the Prescaler divider set by bit M(2). This divided signal frequency is compared by a phase detector with the divided Reference signal.
B(0-11)	

Operational Modes

BIT	DESCRIPTION				
M(0)	(PLL_PE), Phase Lock Loop Power Enable. 1 = Enable, 0 = Power Down. Serial port always on.				
M(2)	Prescaler Select. 0 = 32/33, 1 = 64/65				
M(3) M(4)	Charge Pump Current Setting	M(4)	M(3)	OUTPUT SINK/SOURCE	
		0	0	0.25mA	
		0	1	0.50mA	
		1	0	0.75mA	
		1	1	1.00mA	
M(5) M(6)	Charge Pump Sign	M(6)	M(5)		
		0	0	Source Current if $LO/[P*B+A] < Ref/R$	
		0	1	Source Current if $LO/[P*B+A] > Ref/R$	
M(7) M(8) M(13)	LD Pin Multiplex Operation	M(13)	M(8)	M(7)	OUTPUT AT PIN LD
		0	0	X	Lock Detect Operation
		0	1	X	Short to GND
		1	0	X	Serial Register Read Back
		1	1	0	Ref. Divided by R Waveform
		1	1	1	LO Divided by $[P*B+A]$ Waveform
M(14) M(15)	Charge Pump Operation/Test	M(15)	M(14)	OPERATION/TEST	
		0	0	Normal Operation	
		0	1	Charge Pump Constant Current Source	
		1	0	Charge Pump Constant Current Sink	
		1	1	High Impedance State	

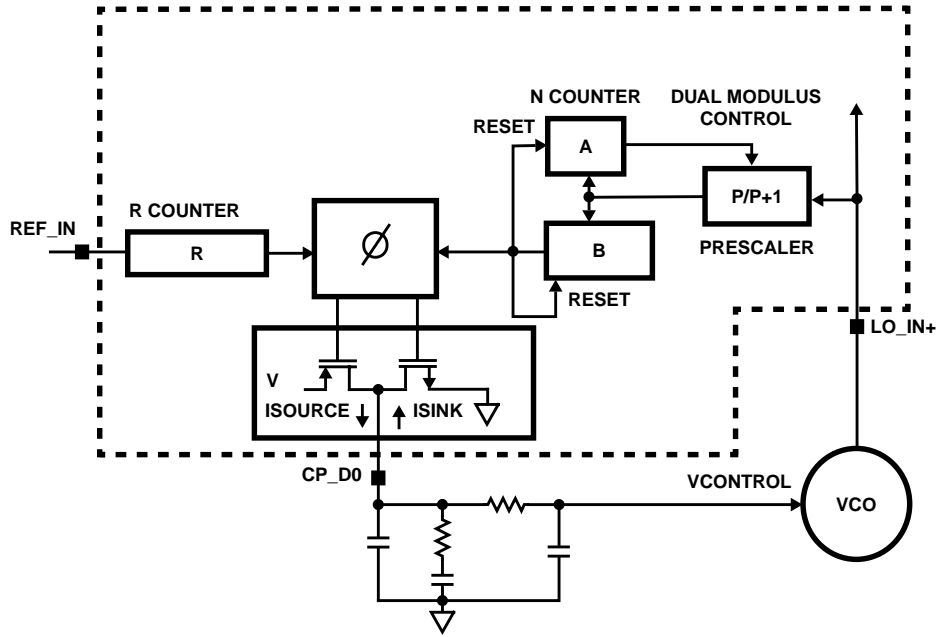
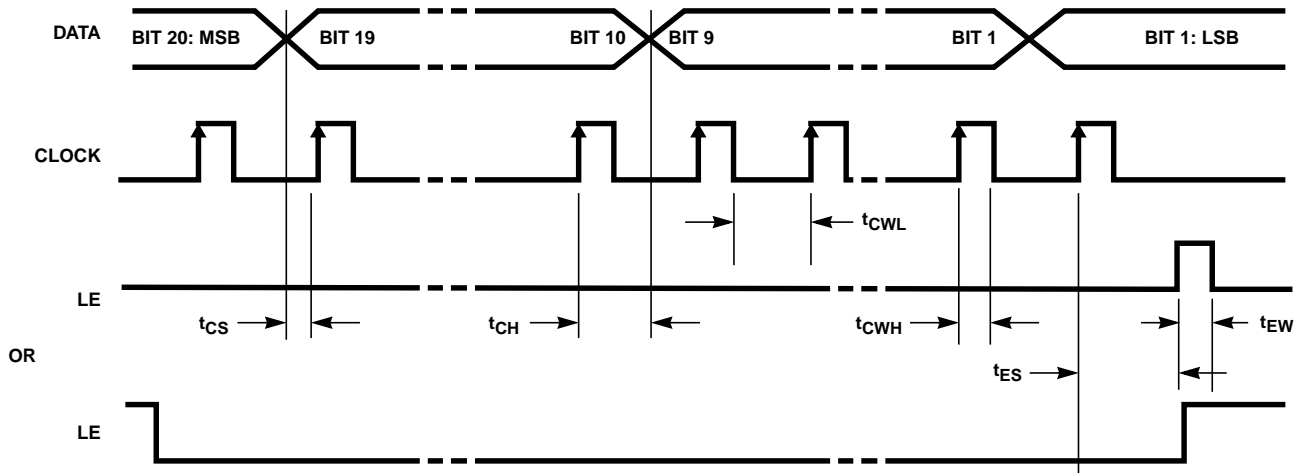

FIGURE 1. PLL SIMPLIFIED BLOCK DIAGRAM



NOTES:

- 9. Parenthesis data indicates programmable reference divider data.
- 10. Data shifted into register on clock rising edge.
- 11. Data is shifted in MSB first.

FIGURE 2. SERIAL DATA INPUT TIMING

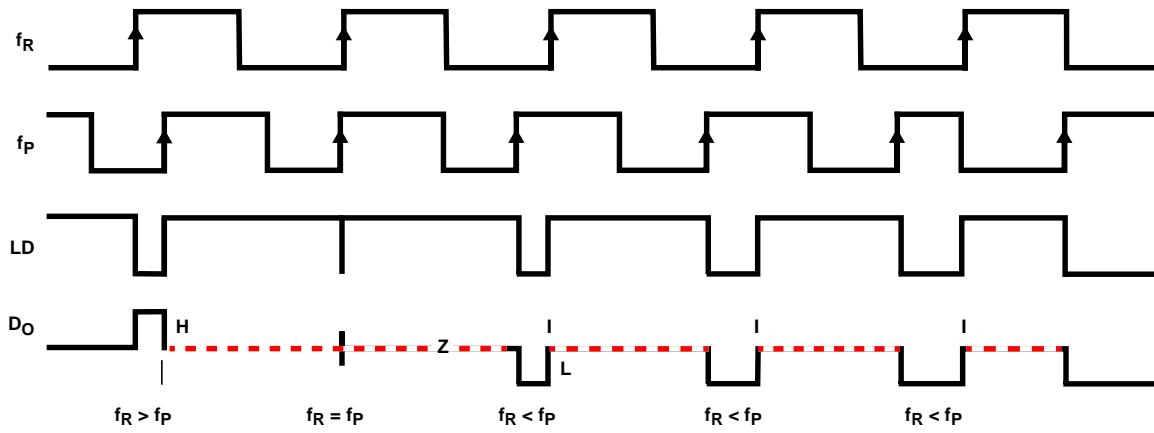

NOTES:

12. Phase difference detection range: -2π to $+2\pi$.
13. The minimum width pump up and pump down current pulses occur at the D_O pin when the loop is locked.

FIGURE 3. PHASE COMPARATOR AND INTERNAL CHARGE PUMP CHARACTERISTICS

Typical Evaluation Board Application

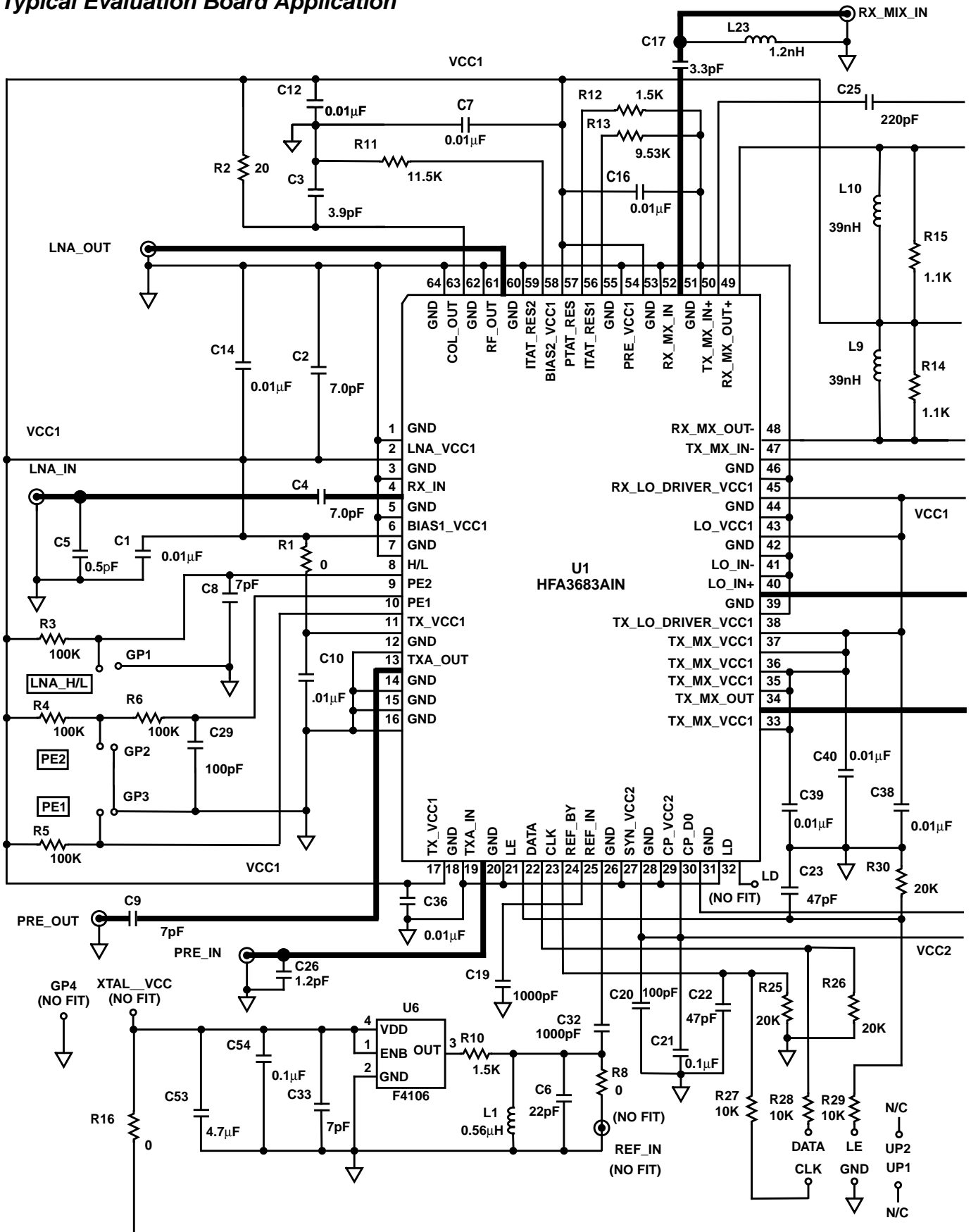

Typical Evaluation Board Application (Continued)

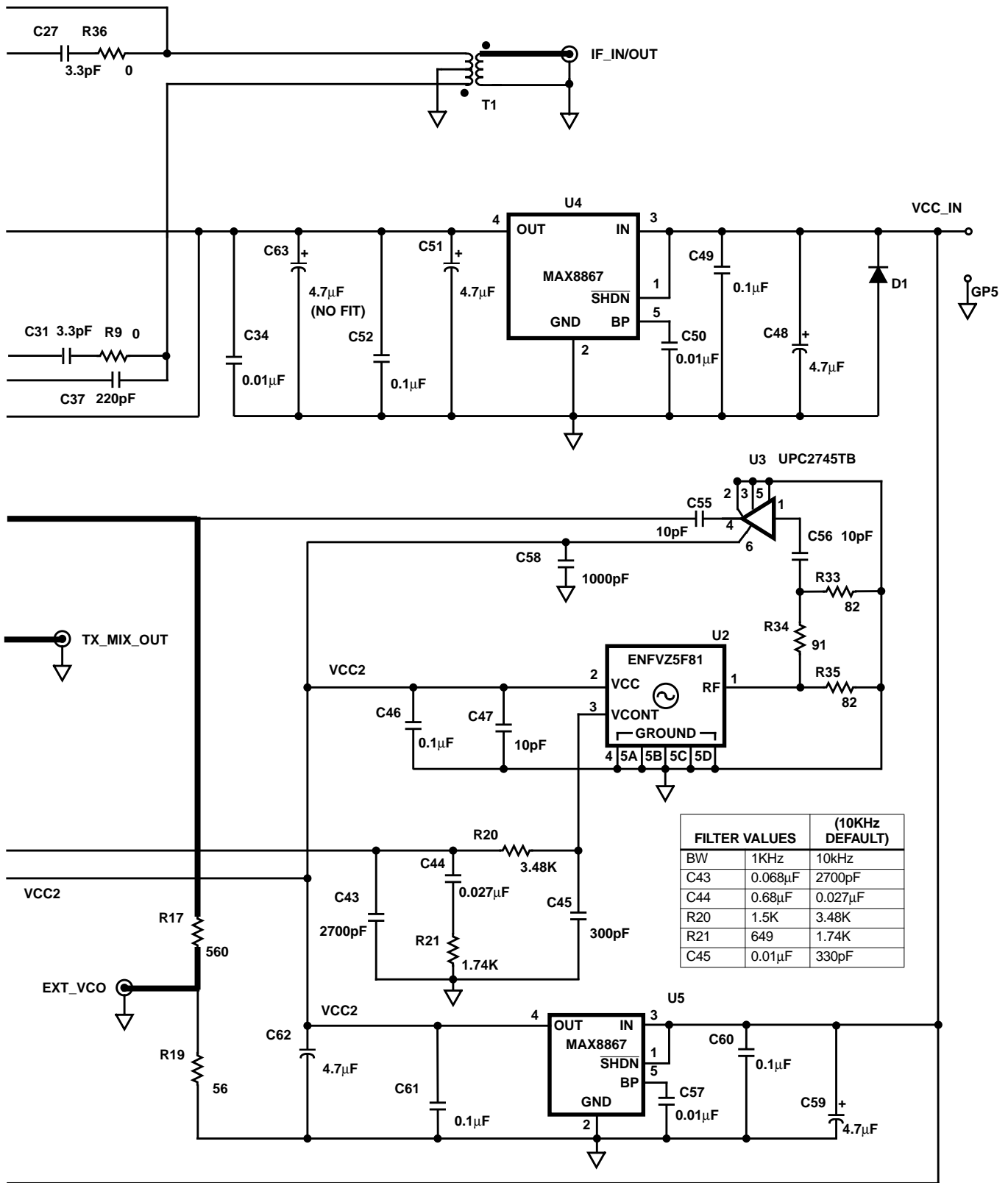

Typical Performance Curves

V_{CC} = 3.30V
 RF = 2.0GHz TO 3.0GHz
 ROOM TEMP
 Pin = -30.dBm

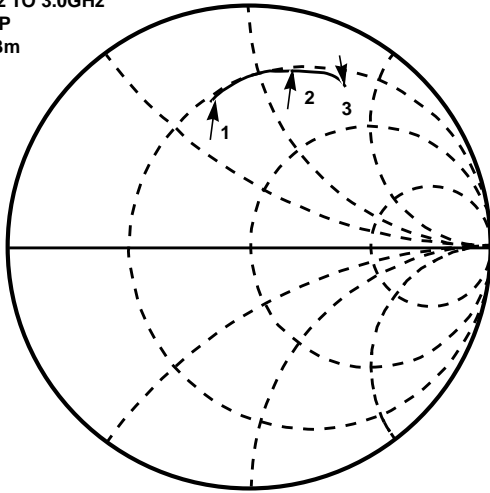

Marker 1 = 2.0GHz, Real = 17.6Ω, Imaginary = 35.2Ω
 Marker 2 = 2.45GHz, Real = 18.2Ω, Imaginary = 60.1Ω
 Marker 3 = 3.0GHz, Real = 24.6Ω, Imaginary = 82.5Ω

FIGURE 4. S11 LNA in HIGH GAIN

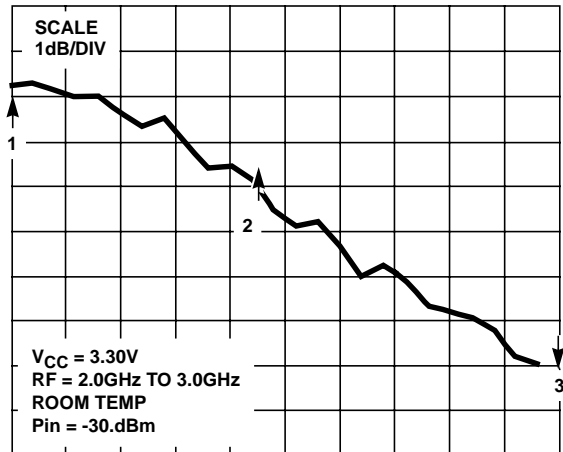

Marker 1 = 2.0GHz, 14.9dB
 Marker 2 = 2.45GHz, 13.4dB
 Marker 3 = 3.0GHz, 9.1dB

FIGURE 5. S21 LNA in HIGH GAIN

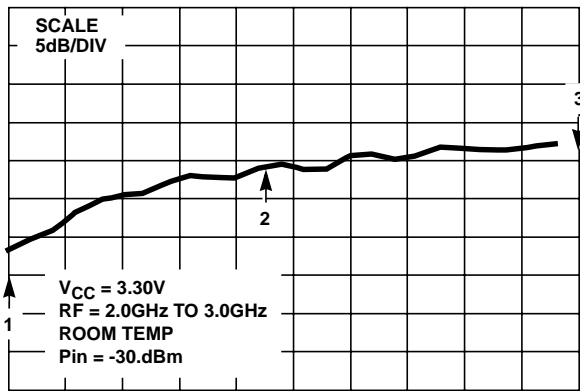

Marker 1 = 2.0GHz, -50.3dB
 Marker 2 = 2.45GHz, 36.9dB
 Marker 3 = 3.0GHz, -32.8dB

FIGURE 6. S12 LNA in HIGH GAIN

V_{CC} = 3.30V
 RF = 2.0GHz TO 3.0GHz
 ROOM TEMP
 Pin = -30.dBm

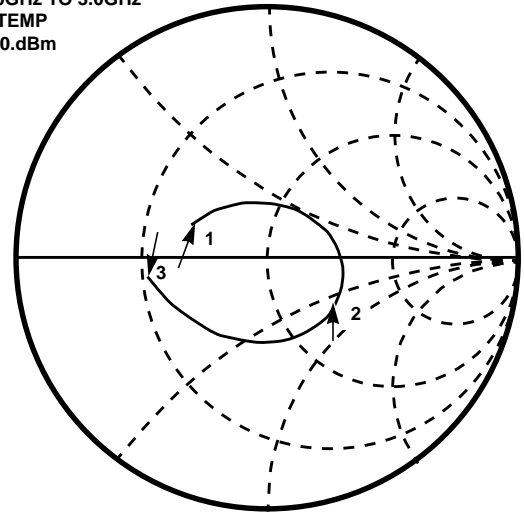

Marker 1 = 2.0GHz, Real = 25.6Ω, Imaginary = 8.1Ω
 Marker 2 = 2.45GHz, Real = 79.5Ω, Imaginary = -30.6Ω
 Marker 3 = 3.0GHz, Real = 17.4Ω, Imaginary = -3.2Ω

FIGURE 7. S22 LNA in HIGH GAIN

Typical Performance Curves (Continued)

V_{CC} = 3.30V
 RF = 2.0GHz TO 3.0GHz
 ROOM TEMP
 Pin = -30.dBm

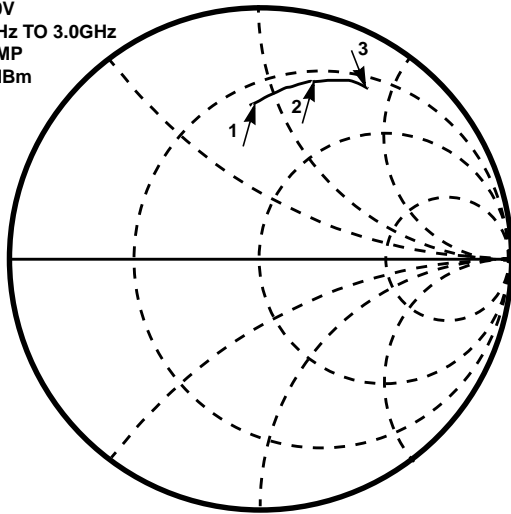

Marker 1 = 2.0GHz, Real = 21.5Ω, Imaginary = 42.5Ω
 Marker 2 = 2.45GHz, Real = 20.4Ω, Imaginary = 64.0Ω
 Marker 3 = 3.0GHz, Real = 22.6Ω, Imaginary = 87.0Ω

FIGURE 8. S11 LOW GAIN LNA

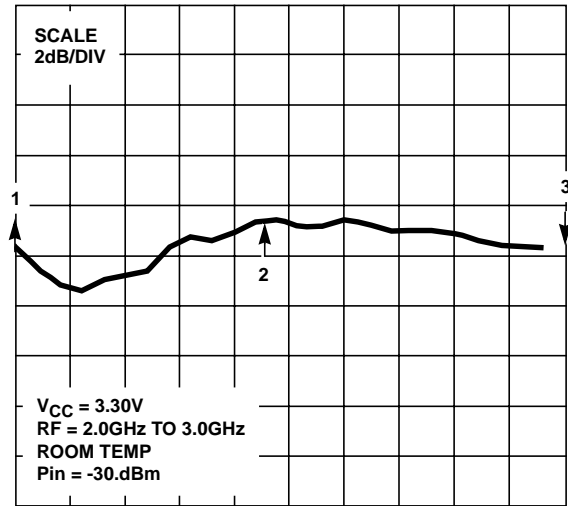

Marker 1 = 2.0GHz, -16.4dB
 Marker 2 = 2.45GHz, -16.4dB
 Marker 3 = 3.0GHz, -17.2dB

FIGURE 9. S21 LOW GAIN LNA

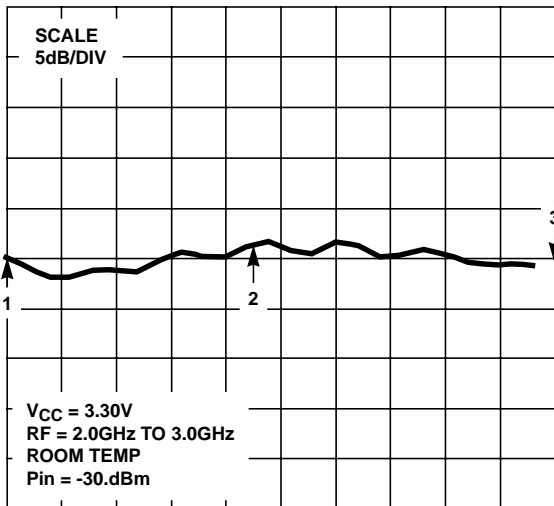

Marker 1 = 2.0GHz, -16.4dB
 Marker 2 = 2.45GHz, 16.5dB
 Marker 3 = 3.0GHz, -17.6dB

FIGURE 10. S12 LOW GAIN LNA

V_{CC} = 3.30V
 RF = 2.0GHz TO 3.0GHz
 ROOM TEMP
 Pin = -30.dBm

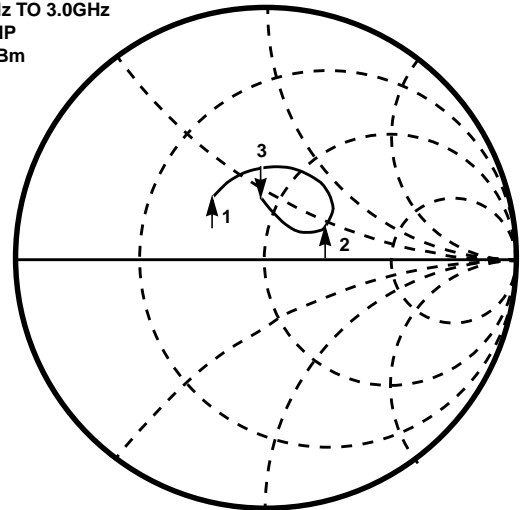

Marker 1 = 2.0GHz, Real = 29.4Ω, Imaginary = 16.5Ω
 Marker 2 = 2.45GHz, Real = 77.7Ω, Imaginary = 22.9Ω
 Marker 3 = 3.0, Real = 43.0Ω, Imaginary = 21.7Ω

FIGURE 11. S22 LOW GAIN LNA

Typical Performance Curves (Continued)

V_{CC} = 3.30V
 RF = 2.0GHz TO 3.0GHz
 ROOM TEMP
 Pin = -30dBm

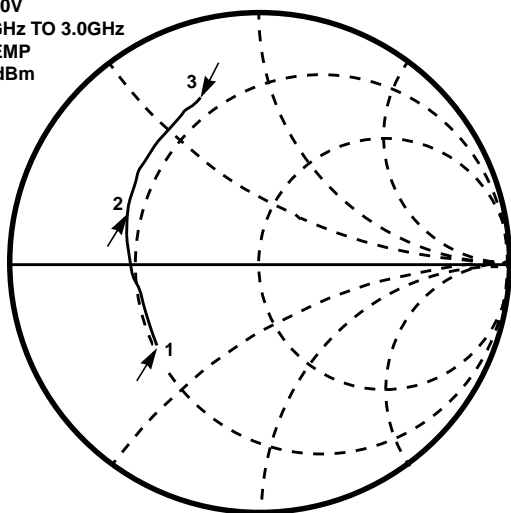

Marker 1 = 2.0GHz, Real = 17.4Ω, Imaginary = -14.8Ω
 Marker 2 = 2.4GHz, Real = 14.1Ω, Imaginary = 9.8Ω
 Marker 3 = 3.0GHz, Real = 13.1Ω, Imaginary = 33.8Ω

FIGURE 12. S11 RX MIXER

V_{CC} = 3.30V
 RF = 2.0GHz TO 3.0GHz
 ROOM TEMP
 Pin = -30.dBm

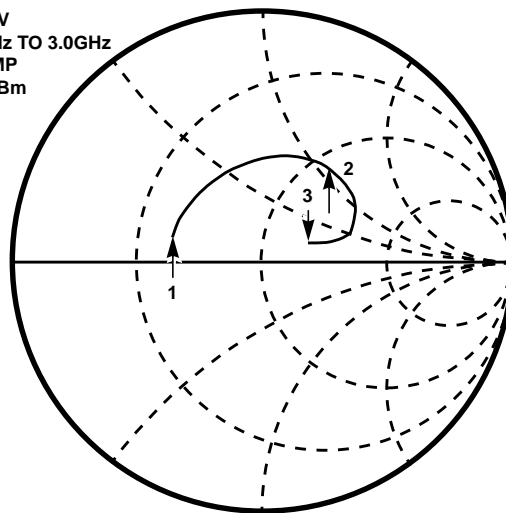

Marker 1 = 2.0GHz, Real = 23.4Ω, Imaginary = 5.9Ω
 Marker 2 = 2.45GHz, Real = 59.9Ω, Imaginary = 55.7Ω
 Marker 3 = 3.0GHz, Real = 72.4Ω, Imaginary = 12.5Ω

FIGURE 13. S22 TX MIXER

V_{CC} = 3.30V
 RF = 2.0GHz TO 3.0GHz
 ROOM TEMP
 Pin = -30dBm

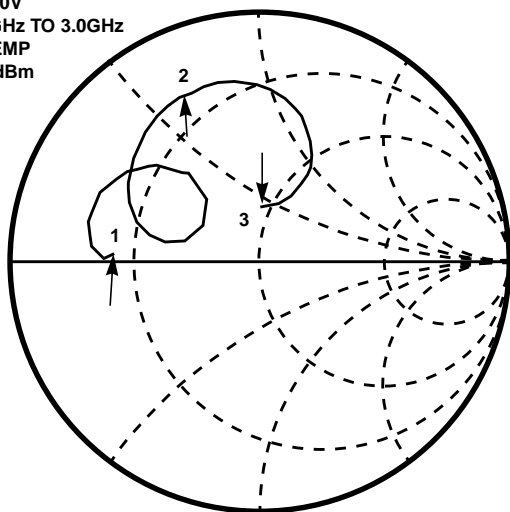

Marker 1 = 2.0GHz, Real = 13.2Ω, Imaginary = 1.2Ω
 Marker 2 = 2.45GHz, Real = 11.2Ω, Imaginary = 31.6Ω
 Marker 3 = 3.0GHz, Real = 46.6Ω, Imaginary = 21.7Ω

FIGURE 14. S11 PREAMP

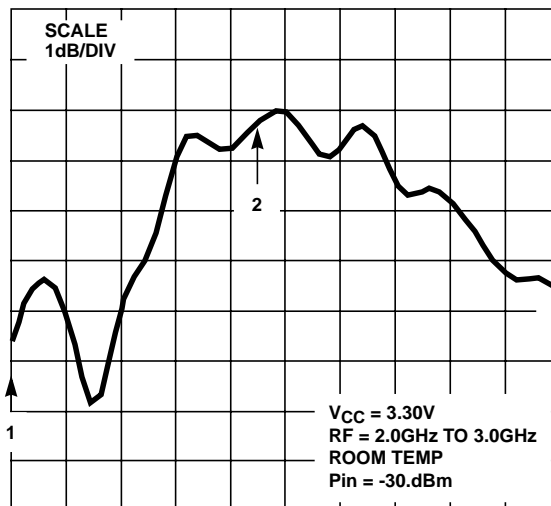

Marker 1 = 2.0GHz, 10.7dB
 Marker 2 = 2.45GHz, 15.5dB
 Marker 3 = 3.0GHz, 12.5dB

FIGURE 15. S21 PREAMP

Typical Performance Curves (Continued)

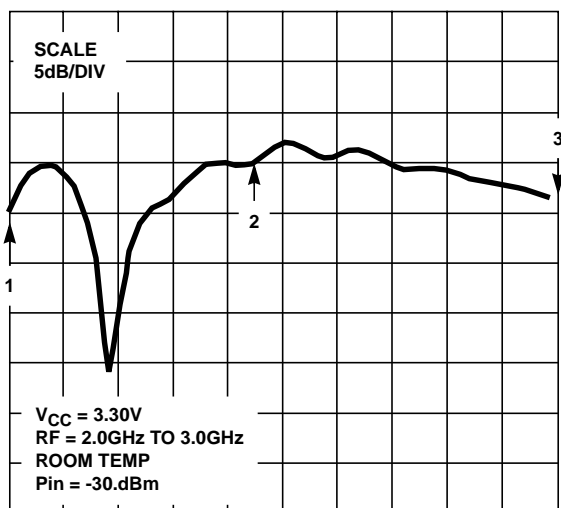

Marker 1 = 2.0GHz, -35.2dB
 Marker 2 = 2.45GHz, 30.1dB
 Marker 3 = 3.0GHz, -33.3dB

FIGURE 16. S12 PREAMP

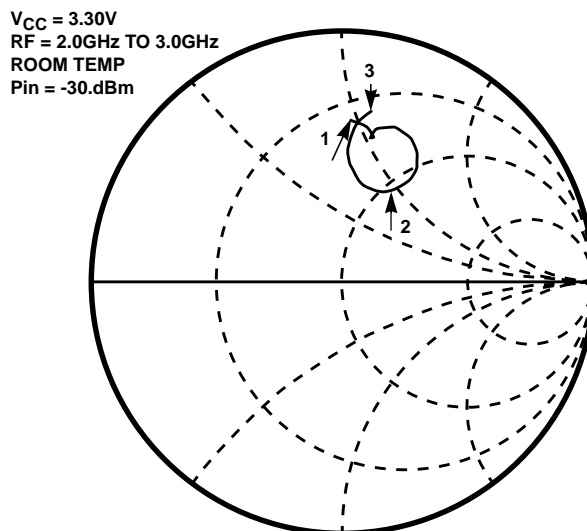

Marker 1 = 2.0GHz, Real = 21.9Ω, Imaginary = 48.0Ω
 Marker 2 = 2.45GHz, Real = 53.4Ω, Imaginary = 46.5Ω
 Marker 3 = 3.0GHz, Real = 21.4Ω, Imaginary = 54.6Ω

FIGURE 17. S22 PREAMP

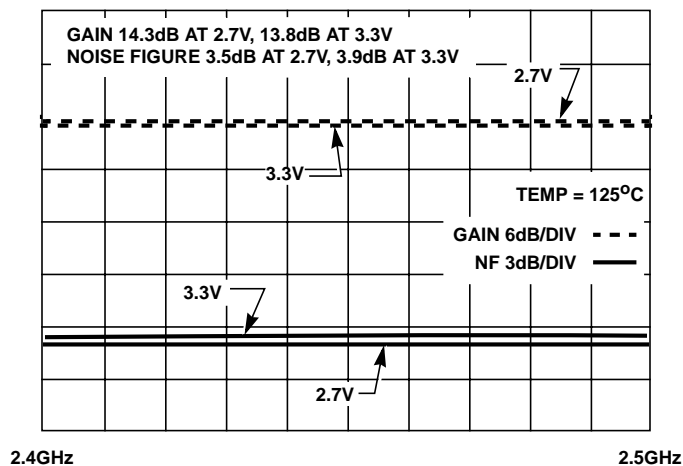

FIGURE 18. LNA HIGH GAIN AND NOISE FIGURE vs SUPPLY VOLTAGE

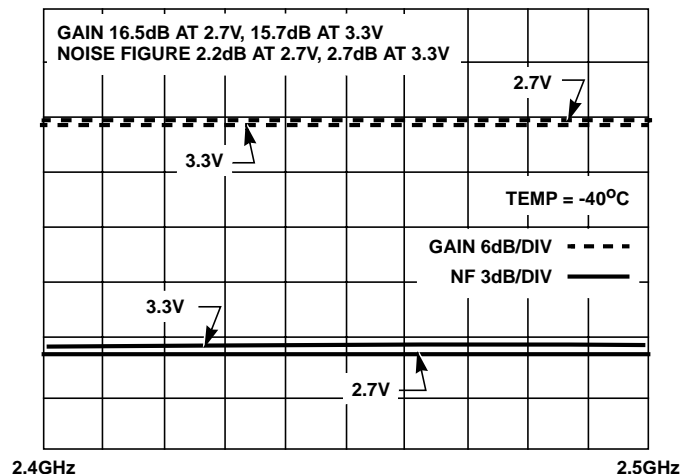

FIGURE 19. LNA HIGH GAIN AND NOISE FIGURE vs SUPPLY VOLTAGE

Typical Performance Curves (Continued)

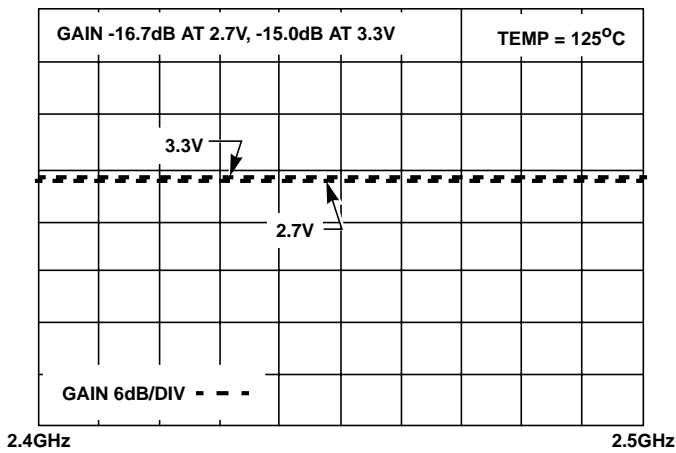

FIGURE 20. LNA LOW GAIN vs SUPPLY VOLTAGE

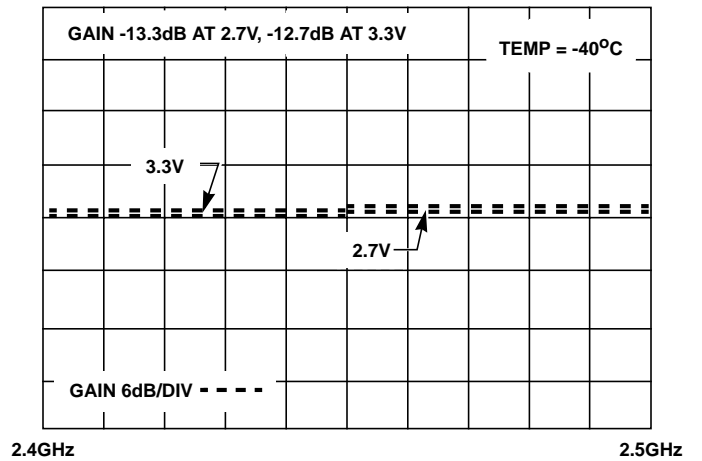

FIGURE 21. LNA LOW GAIN vs SUPPLY VOLTAGE

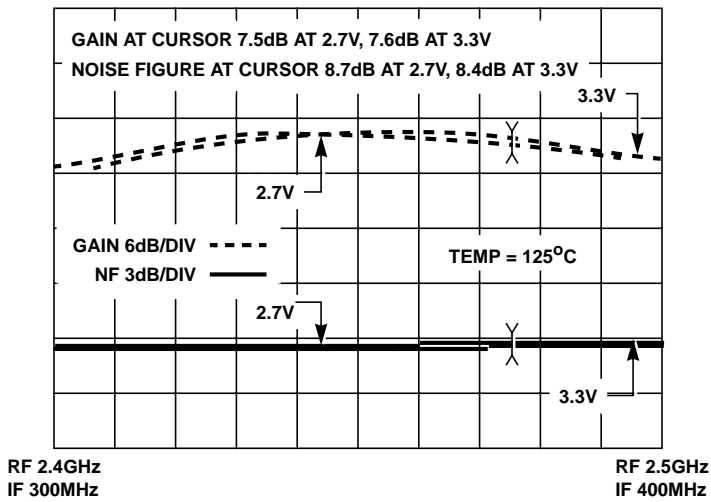

FIGURE 22. RX MIXER GAIN AND SSB NOISE FIGURE vs SUPPLY VOLTAGE

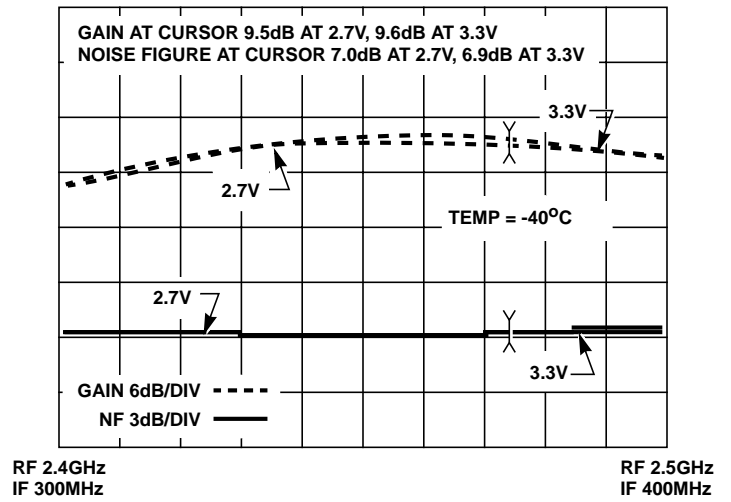

FIGURE 23. RX MIXER GAIN AND SSB NOISE FIGURE vs SUPPLY VOLTAGE

Typical Performance Curves (Continued)

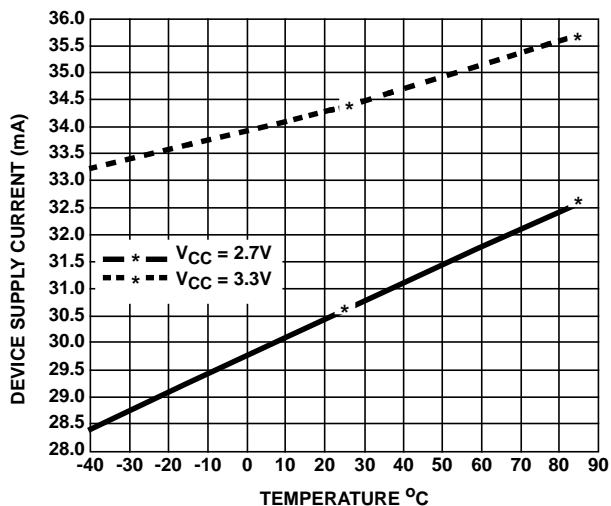

FIGURE 24. RECEIVE TOTAL SUPPLY CURRENT (LNA IN HIGH GAIN)

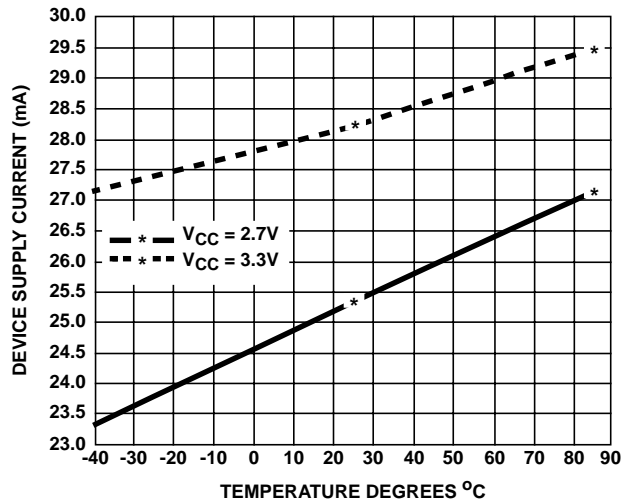

FIGURE 25. RECEIVE TOTAL SUPPLY CURRENT (LNA IN LOW GAIN)

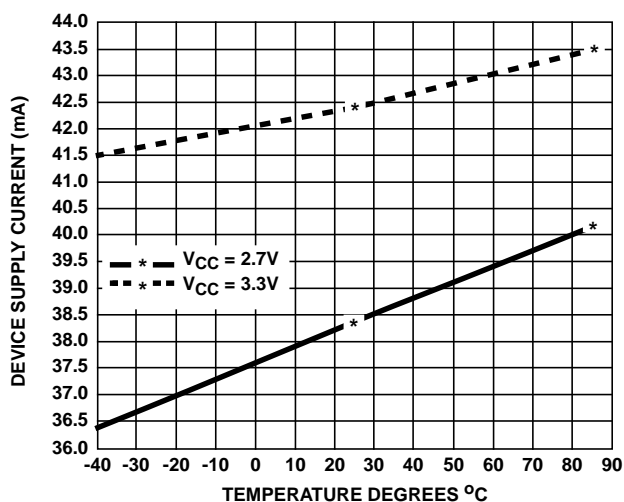

FIGURE 26. TRANSMIT TOTAL SUPPLY CURRENT

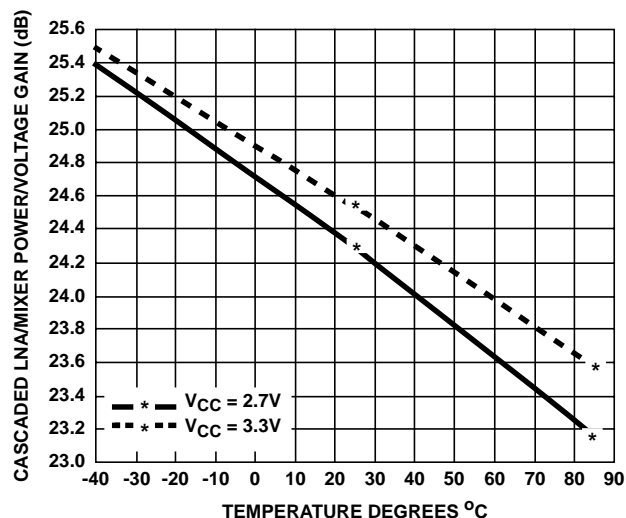

FIGURE 27. POWER/VOLTAGE GAIN HIGH GAIN MODE

Typical Performance Curves (Continued)

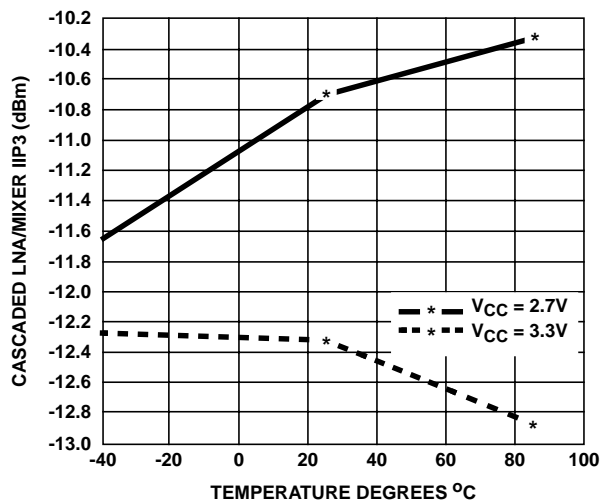

FIGURE 28. INPUT IP3 HIGH GAIN MODE

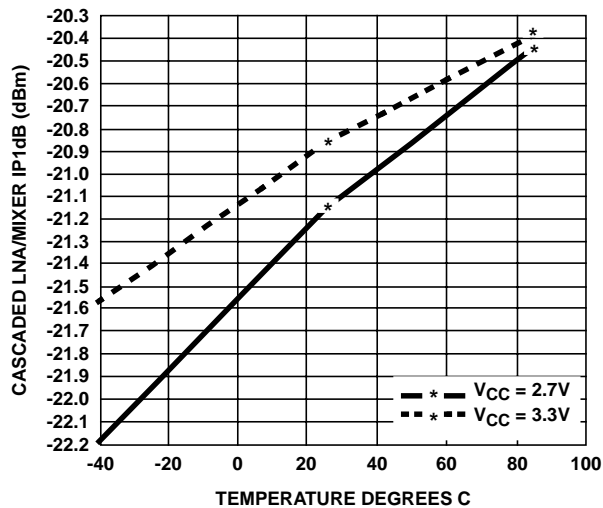

FIGURE 29. INPUT P1dB HIGH GAIN MODE

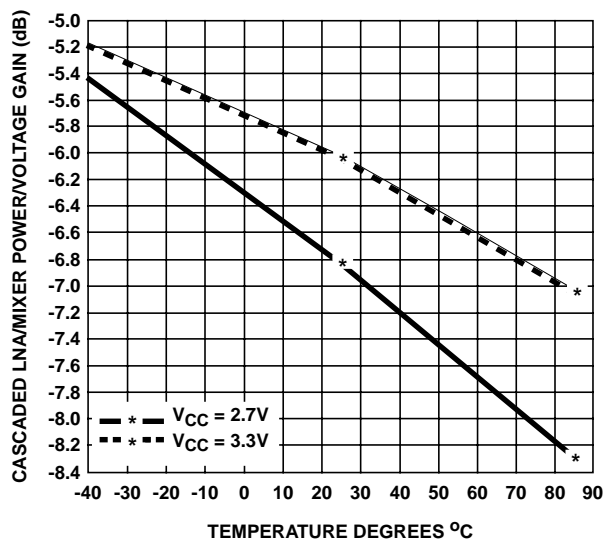

FIGURE 30. POWER/VOLTAGE GAIN LOW GAIN MODE

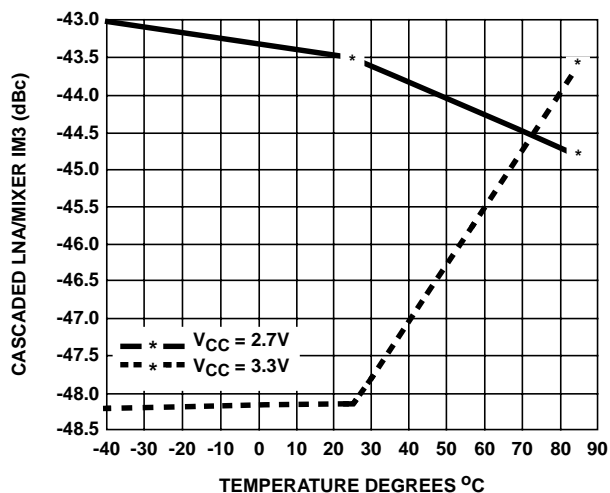

FIGURE 31. RX OUTPUT IM3 AT -5dBm INPUT TONES

Typical Performance Curves (Continued)

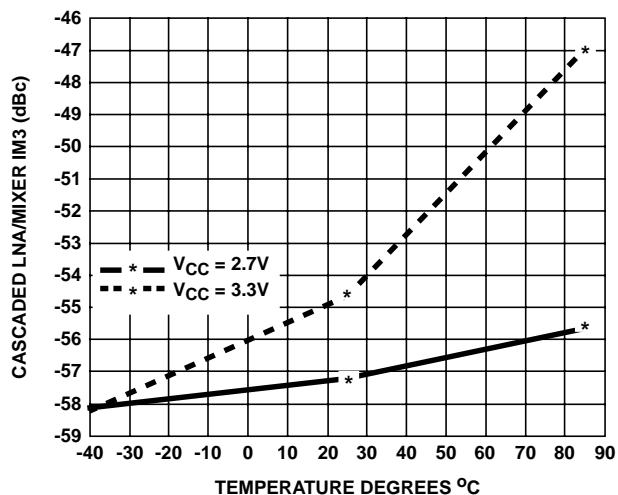

FIGURE 32. RX OUTPUT IM3 AT -12dBm INPUT TONES

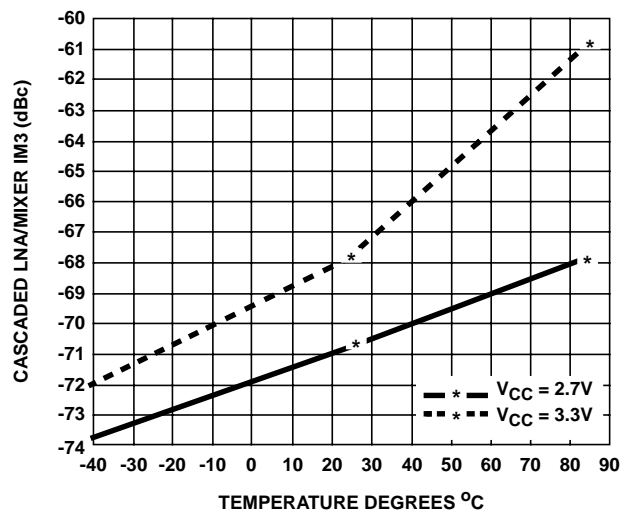

FIGURE 33. RX OUTPUT IM3 AT -20dBm INPUT TONES

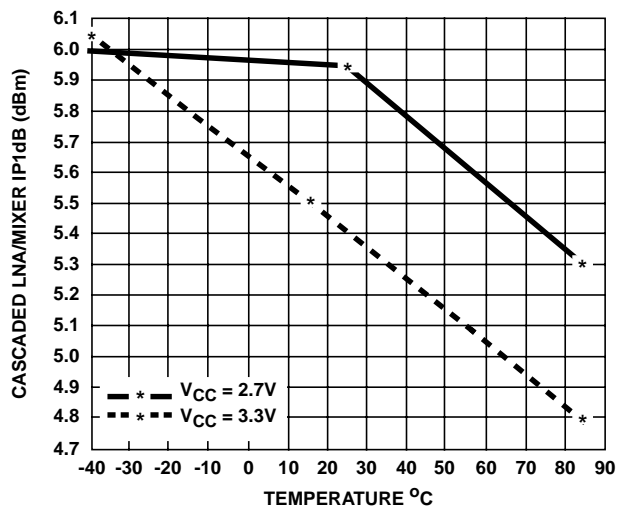

FIGURE 34. INPUT P1dB LOW GAIN MODE

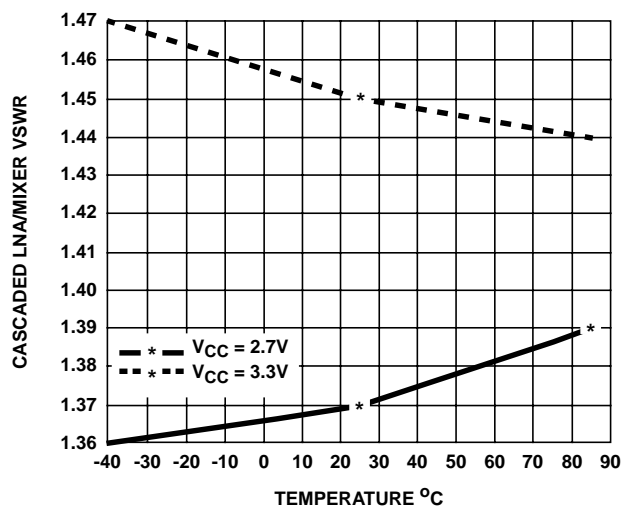

FIGURE 35. LNA INPUT 50Ω VSWR HIGH GAIN MODE

Typical Performance Curves (Continued)

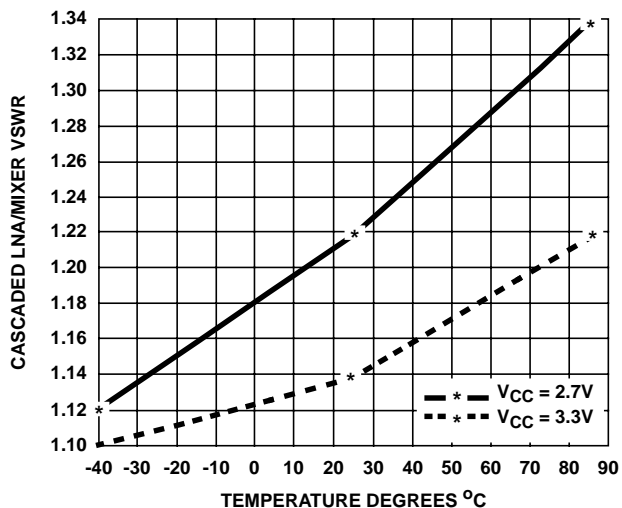

FIGURE 36. LNA INPUT 50Ω VSWR LOW GAIN MODE

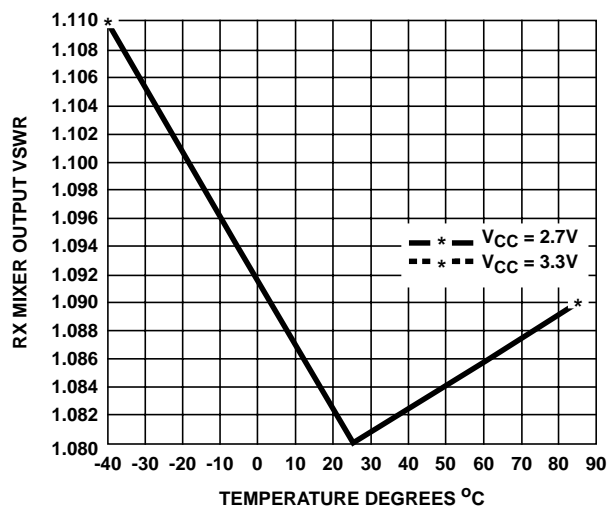

FIGURE 37. RX MIXER OUT VSWR

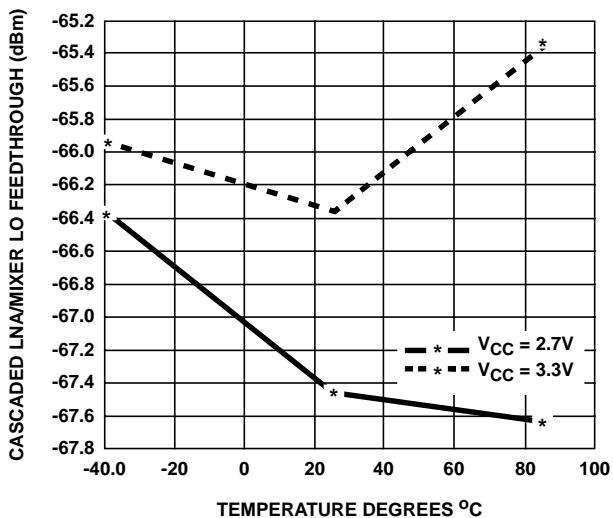

FIGURE 38. LO TO LNA INPUT FEEDTHROUGH (CASCADED, NO FILTER)

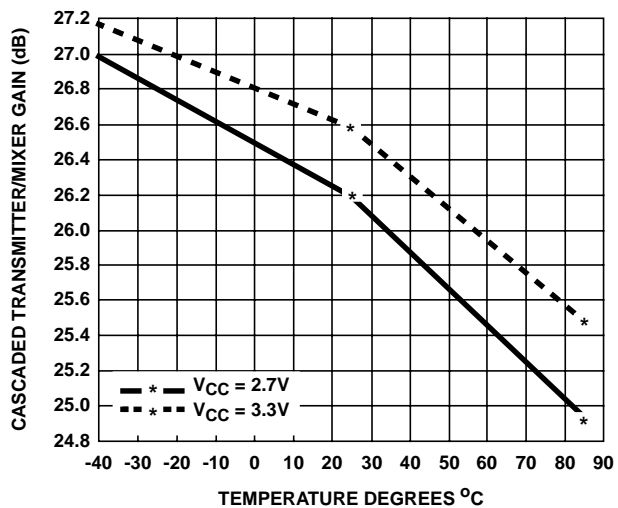

FIGURE 39. POWER CONVERSION GAIN

Typical Performance Curves (Continued)

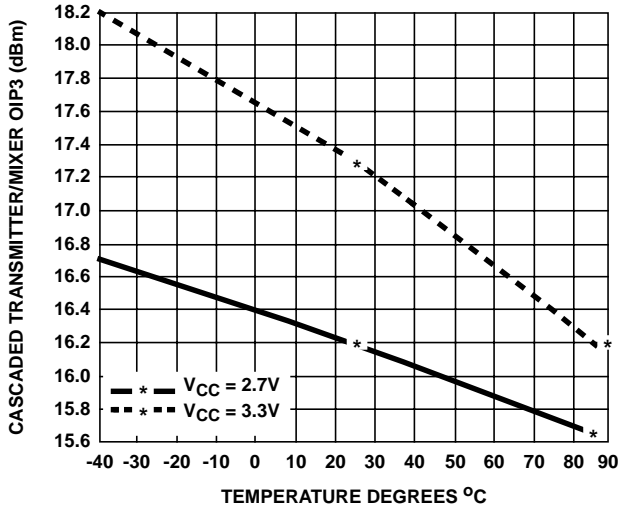

FIGURE 40. OUTPUT IP3

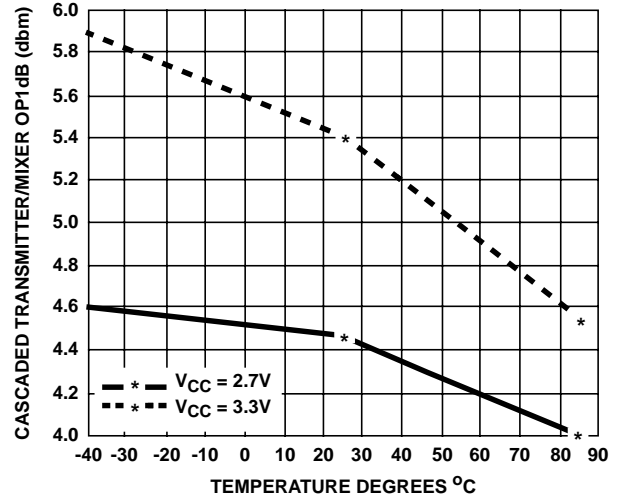

FIGURE 41. OUTPUT P1dB

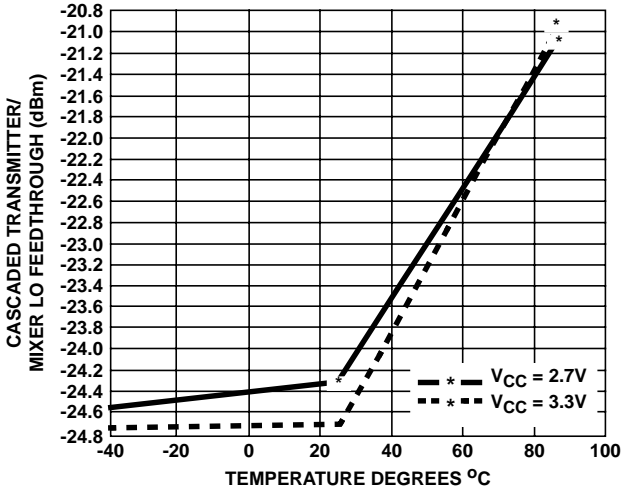

FIGURE 42. LO TO TRANSMIT AMP OUTPUT FEEDTHROUGH (CASCADED, NO FILTER)

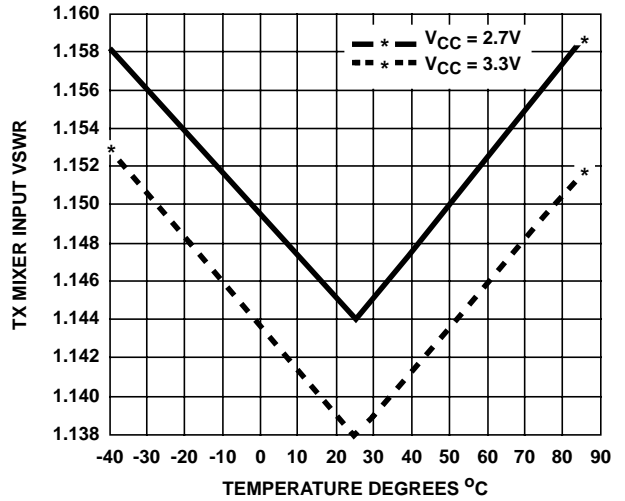

FIGURE 43. TX MIXER INPUT VSWR

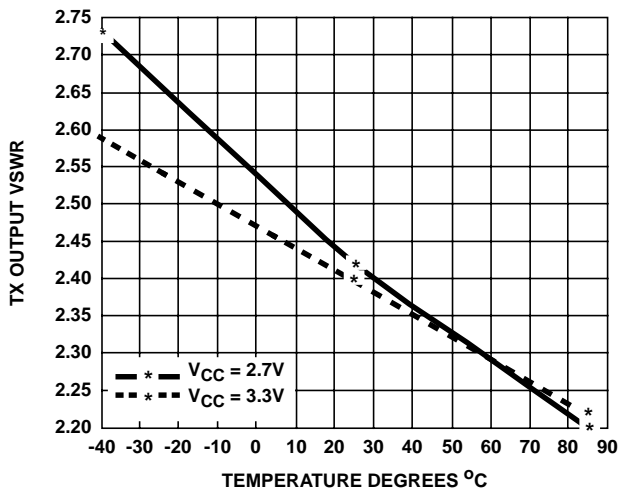

FIGURE 44. PREAMPLIFIER OUTPUT 50Ω VSWR

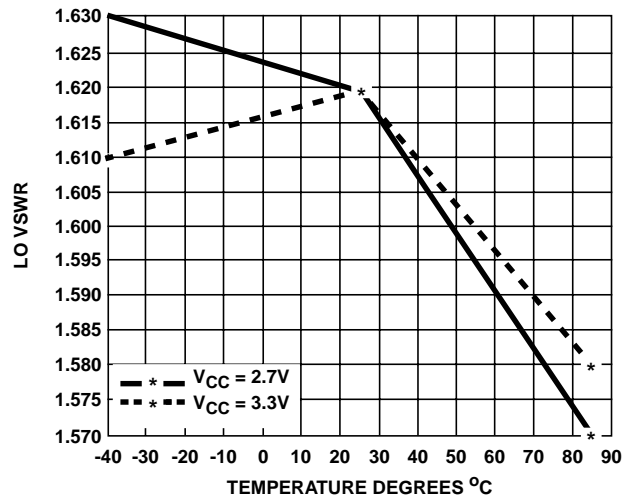

FIGURE 45. LO 50Ω VSWR

Typical Performance Curves (Continued)

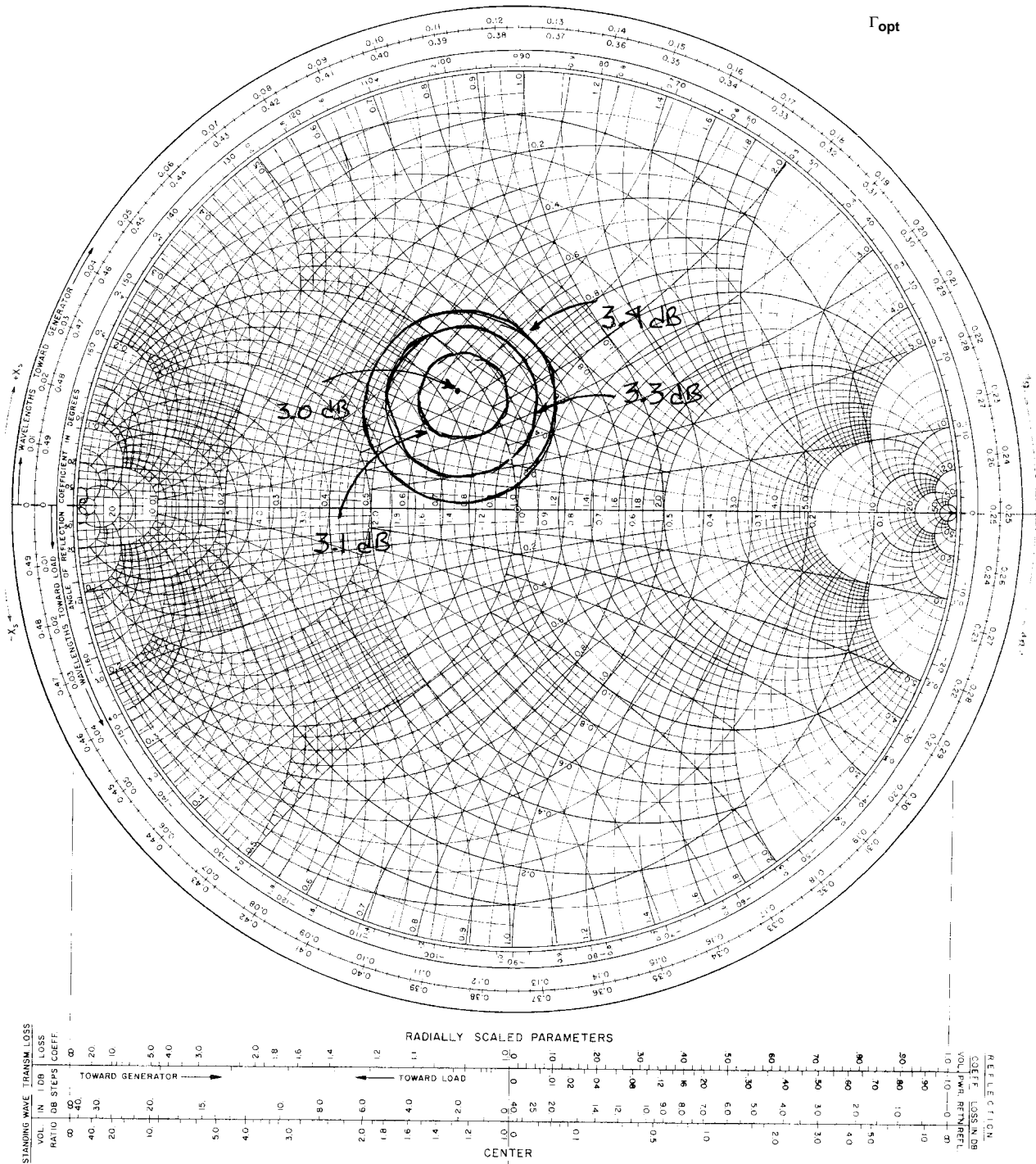

FIGURE 46. GAMMA OPT

All Intersil products are manufactured, assembled and tested utilizing ISO9000 quality systems. Intersil Corporation's quality certifications can be viewed at website www.intersil.com/quality/iso.asp.

Intersil products are sold by description only. Intersil Corporation reserves the right to make changes in circuit design and/or specifications at any time without notice. Accordingly, the reader is cautioned to verify that data sheets are current before placing orders. Information furnished by Intersil is believed to be accurate and reliable. However, no responsibility is assumed by Intersil or its subsidiaries for its use, nor for any infringements of patents or other rights of third parties which may result from its use. No license is granted by implication or otherwise under any patent or patent rights of Intersil or its subsidiaries.

For information regarding Intersil Corporation and its products, see web site www.intersil.com