

HM628128 Series

131072-word × 8-bit High Speed CMOS Static RAM

The Hitachi HM628128 is a CMOS static RAM organized 128-kword × 8-bit. It realizes higher density, higher performance and low power consumption by employing 0.8 μm Hi-CMOS process technology.

It offers low power standby power dissipation; therefore, it is suitable for battery back-up systems. The device, packaged in a 525-mil SOP (460-mil body SOP) or a 600-mil plastic DIP, or a 8 × 20 mm TSOP with thickness of 1.2 mm, is available for high density mounting. The TSOP package is suitable for cards, and reverse type TSOP is also provided.

Features

- High speed: fast access time 70/85/100/120 ns (max)
- Low power
 - Standby: 10 μW (typ) (L/L-L/L-SL version)
 - Operation: 75 mW (typ)
- Single 5 V supply
- Completely static memory
 - No clock or timing strobe required
- Equal access and cycle times
- Common data input and output: Three state output
- Directly TTL compatible: All inputs and outputs
- Capability of battery back up operation (L/L-L/L-SL version) (2 chip selection for battery back up)

5

4496203 0024973 218

HITACHI

Hitachi America, Ltd. • Hitachi Plaza • 2000 Sierra Point Pkwy. • Brisbane, CA 94005-1819 • (415) 589-8300

5-39

HM628128 Series

Ordering Information

Type No.	Access time	Package	Type No.	Access time	Package
HM628128P-7	70 ns	600-mil, 32-pin plastic DIP (DP-32)	HM628128FP-7	70 ns	525 mil, 32-pin plastic SOP (FP-32D)
HM628128P-8	85 ns				
HM628128P-10	100 ns				
HM628128P-12	120 ns				
HM628128LP-7	70 ns		HM628128LFP-7	70 ns	
HM628128LP-8	85 ns				
HM628128LP-10	100 ns				
HM628128LP-12	120 ns				
HM628128LP-7SL	70 ns		HM628128LFP-7SL	70 ns	
HM628128LP-8SL	85 ns				
HM628128LP-10SL	100 ns				
HM628128LP-12SL	120 ns				
HM628128T-7	70 ns	8mm x 20mm 32-pin TSOP (normal type) (TFP-32D)	HM628128R-7	70 ns	8mm x 20 mm 32-pin TSOP (reverse type) (TFP-32DR)
HM628128T-8	85 ns				
HM628128T-10	100 ns				
HM628128T-12	120 ns				
HM628128LT-7	70 ns		HM628128LR-7	70 ns	
HM628128LT-8	85 ns				
HM628128LT-10	100 ns				
HM628128LT-12	120 ns				
HM628128LT-7L	70 ns		HM628128LR-7L	70 ns	
HM628128LT-8L	85 ns				
HM628128LT-10L	100 ns				
HM628128LT-12L	120 ns				
HM628128LT-7SL	70 ns		HM628128LR-7SL	70 ns	
HM628128LT-8SL	85 ns				
HM628128LT-10SL	100 ns				
HM628128LT-12SL	120 ns				

4496203 0024974 154

HITACHI

5-40

Hitachi America, Ltd. • Hitachi Plaza • 2000 Sierra Point Pkwy. • Brisbane, CA 94005-1819 • (415) 589-8300

This Material Copyrighted By Its Respective Manufacturer

HM628128 Series

Pin Arrangement

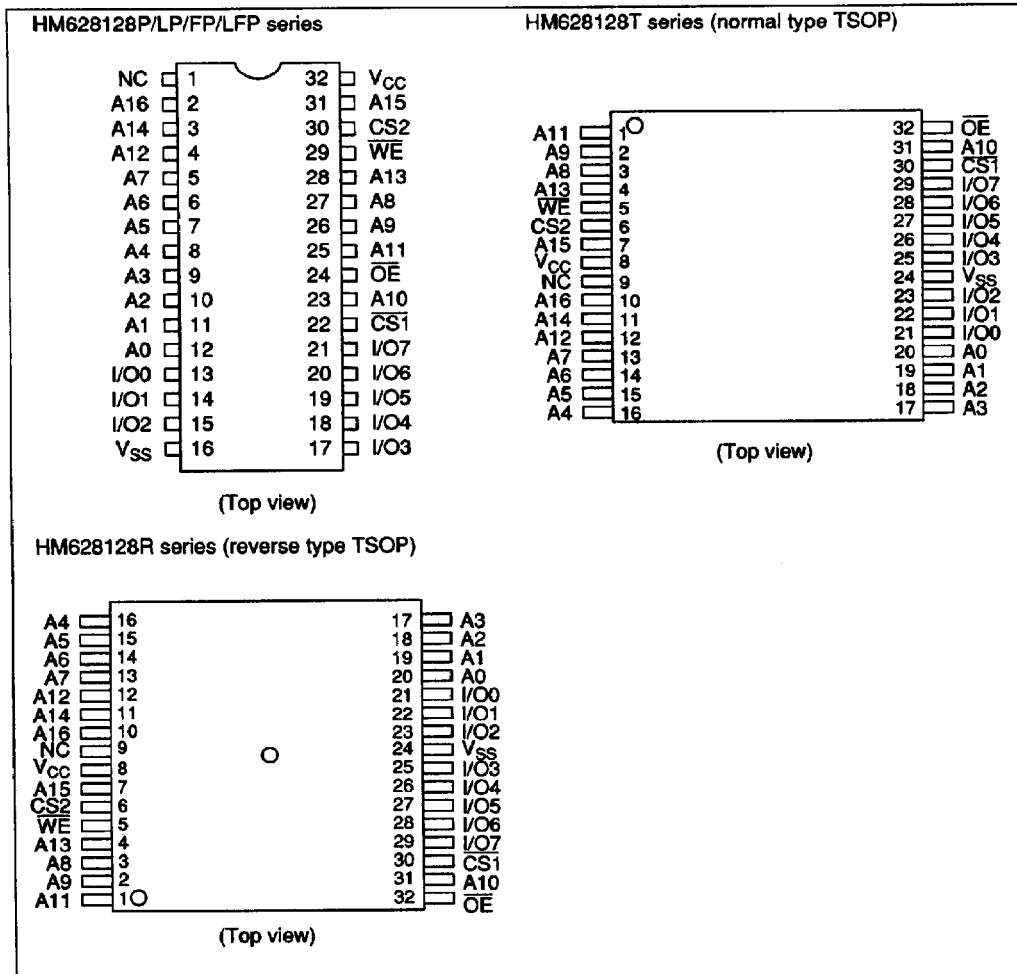

Pin Description

Pin name	Function	Pin name	Function
A0–A16	Address	OE	Output enable
I/O0–I/O7	Input/output	NC	Not connected
CS1	Chip select 1	V _{CC}	Power supply
CS2	Chip select 2	V _{SS}	Ground
WE	Write enable		

4496203 0024975 090 **HITACHI**

Hitachi America, Ltd. • Hitachi Plaza • 2000 Sierra Point Pkwy. • Brisbane, CA 94005-1819 • (415) 589-8300

5-41

5

HM628128 Series

Block Diagram

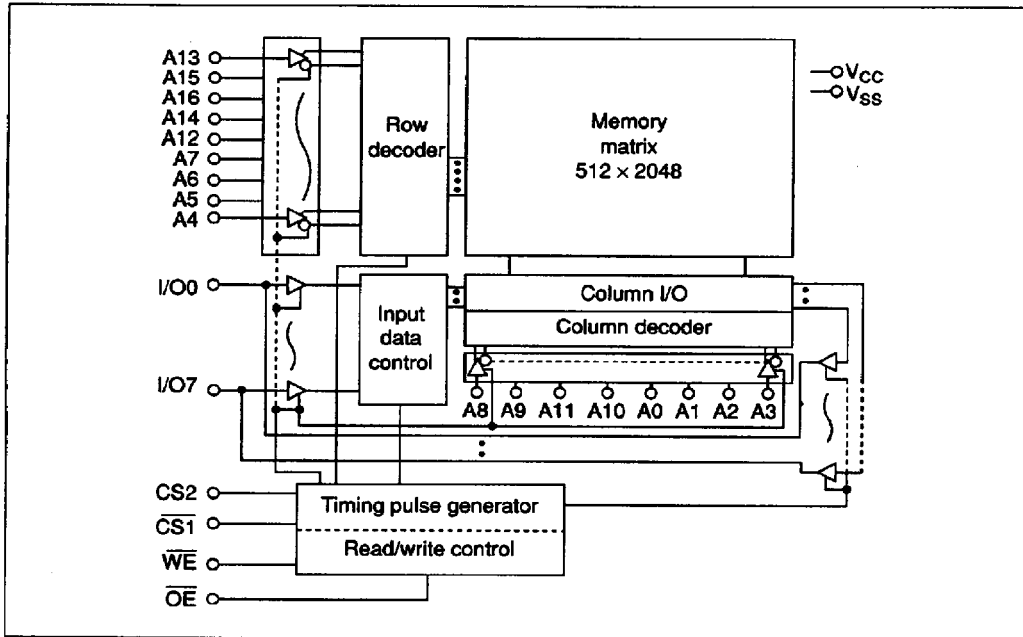

Truth Table

\overline{WE}	$\overline{CS1}$	$\overline{CS2}$	\overline{OE}	Mode	V_{CC} current	Dout pin	Cycle
x	H	x	x	Not selected	I_{SB}, I_{SB1}	High-Z	—
x	x	L	x		I_{SB}, I_{SB1}	High-Z	—
H	L	H	H	Output disable	I_{CC}	High-Z	—
H	L	H	L	Read	I_{CC}	Dout	Read cycle
L	L	H	H	Write	I_{CC}	D_{IN}	Write cycle (1)
L	L	H	L		I_{CC}	D_{IN}	Write cycle (2)

Note: x: H or L

4496203 0024976 T27

HITACHI

5-42

Hitachi America, Ltd. • Hitachi Plaza • 2000 Sierra Point Pkwy. • Brisbane, CA 94005-1819 • (415) 589-8300

HM628128 Series

Absolute Maximum Ratings

Parameter	Symbol	Value	Unit
Voltage on any pin relative to V_{SS}	V_T	-0.5 to +7.0	V
Power dissipation	P_T	1.0	W
Operating temperature	T_{opr}	0 to +70	°C
Storage temperature	T_{stg}	-55 to +125	°C
Storage temperature under bias	T_{bias}	-10 to +85	°C

Note: -3.0 V for pulse half-width \leq 30 ns

Recommended DC Operating Conditions ($T_a = 0$ to +70°C)

Parameter	Symbol	Min	Typ	Max	Unit
Supply voltage	V_{CC}	4.5	5.0	5.5	V
	V_{SS}	0	0	0	V
Input high (logic 1) voltage	V_{IH}	2.2	—	6.0	V
Input low (logic 0) voltage	V_{IL}	-0.3*	—	0.8	V

Note: -3.0 V for pulse half-width \leq 30 ns

5**4496203 0024977 963****HITACHI**

Hitachi America, Ltd. • Hitachi Plaza • 2000 Sierra Point Pkwy. • Brisbane, CA 94005-1819 • (415) 589-8300

5-43

HM628128 Series

DC Characteristics ($T_a = 0$ to $+70^\circ\text{C}$, $V_{CC} = 5\text{ V} \pm 10\%$, $V_{SS} = 0\text{ V}$)

Parameter	Symbol	Min	Typ ¹	Max	Unit	Test conditions
Input leakage current	$ I_{LI} $	—	—	2	μA	$V_{IN} = V_{SS}$ to V_{CC}
Output leakage current	$ I_{LO} $	—	—	2	μA	$\overline{CS1} = V_{IH}$ or $CS2 = V_{IL}$ or $\overline{OE} = V_{IH}$ or $WE = V_{IL}$, $V_{IO} = V_{SS}$ to V_{CC}
Operating power supply current: DC	I_{CC}	—	15	35	mA	$\overline{CS1} = V_{IL}$, $CS2 = V_{IH}$, others = V_{IH}/V_{IL} , $I_{IO} = 0\text{ mA}$
Operating power supply current	I_{CC1}	—	45	70	mA	Min. cycle, duty = 100%, $\overline{CS1} = V_{IL}$, $CS2 = V_{IH}$, others = V_{IH}/V_{IL} , $I_{IO} = 0\text{ mA}$
	I_{CC2}	—	15	30	mA	Cycle time = 1 μs , duty = 100%, $I_{IO} = 0\text{ mA}$, $\overline{CS1} \leq 0.2\text{ V}$, $CS2 \geq V_{CC} - 0.2\text{ V}$, $V_{IH} \geq V_{CC} - 0.2\text{ V}$, $V_{IL} \leq 0.2\text{ V}$
Standby power supply current: DC	I_{SB}	—	1	3	mA	$\overline{CS1} = V_{IH}$, $CS2 = V_{IH}$ or $CS2 = V_{IL}$
Standby power supply current (1): DC	I_{SB1}	—	0.02	2	mA	$V_{IN} \geq 0\text{ V}$, $\overline{CS1} \geq V_{CC} - 0.2\text{ V}$, $CS2 \geq V_{CC} - 0.2\text{ V}$ or $0\text{ V} \leq CS2 \leq CS2 = V_{IL}$
		—	2 ²	100 ²	μA	
		—	2 ³	50 ³	μA	
Output low voltage	V_{OL}	—	—	0.4	V	$I_{OL} = 2.1\text{ mA}$
Output high voltage	V_{OH}	2.4	—	—	V	$I_{OH} = -1.0\text{ mA}$

Note: 1. Typical values are at $V_{CC} = 5.0\text{ V}$, $T_a = +25^\circ\text{C}$ and specified loading.
2. These characteristics are guaranteed only for L-version.
3. These characteristics are guaranteed only for L-L/L-SL version.

Capacitance ($T_a = 25^\circ\text{C}$, $f = 1.0\text{ MHz}$)

Parameter	Symbol	Min	Typ	Max	Unit	Test conditions
Input capacitance	C_{in}	—	—	8	pF	$V_{IN} = 0\text{ V}$
Input/output capacitance	C_{IO}	—	—	10	pF	$V_{IO} = 0\text{ V}$

Note: These parameters are sampled and not 100% tested.

4496203 0024978 BTT

HITACHI

5-44

Hitachi America, Ltd. • Hitachi Plaza • 2000 Sierra Point Pkwy. • Brisbane, CA 94005-1819 • (415) 589-8300

HM628128 Series

AC Characteristics (Ta = 0 to +70°C, V_{CC} = 5 V ± 10%, unless otherwise noted)

Test Conditions:

- Input pulse levels: 0.8 V to 2.4 V
- Input and output timing reference: 1.5 V
- Input rise and fall times: 5 ns
- Output load: 1 TTL gate and C_L (100 pF) (Including scope and jig)

Read Cycle

Parameter	Symbol	HM628128-7		HM628128-8		HM628128-10		HM628128-12		Unit
		Min	Max	Min	Max	Min	Max	Min	Max	
Read cycle time	t _{RC}	70	—	85	—	100	—	120	—	ns
Address access time	t _{AA}	—	70	—	85	—	100	—	120	ns
Chip selection (CS1) to output valid	t _{CO1}	—	70	—	85	—	100	—	120	ns
Chip selection (CS2) to output valid	t _{CO2}	—	70	—	85	—	100	—	120	ns
Output enable (OE) output valid	t _{OE}	—	35	—	45	—	50	—	60	ns
Chip selection (CS1) to output in low-Z ^{1,2,3}	t _{LZ1}	10	—	10	—	10	—	10	—	ns
Chip selection (CS2) to output in low-Z ^{1,2,3}	t _{LZ2}	10	—	10	—	10	—	10	—	ns
Output enable (OE) to output in low-Z ^{1,2,3}	t _{OLZ}	5	—	5	—	5	—	5	—	ns
Chip deselection (CS1) to output in high-Z ^{1,2,3}	t _{HZ1}	0	25	0	30	0	35	0	45	ns
Chip deselection (CS2) to output in high-Z ^{1,2,3}	t _{HZ2}	0	25	0	30	0	35	0	45	ns
Output disable (OE) to output in high-Z ^{1,2,3}	t _{OHZ}	0	25	0	30	0	35	0	45	ns
Output hold from address change	t _{OH}	10	—	10	—	10	—	10	—	ns

- Notes: 1. t_{HZ} and t_{OHZ} are defined as the time at which the outputs achieve the open circuit conditions and are not referred to output voltage levels.
 2. At any given temperature and voltage condition, t_{HZ} max is less than t_{LZ} min both for a given device and from device to device.
 3. These parameters are sampled and not 100% tested.

4496203 0024979 736

HITACHI

Hitachi America, Ltd. • Hitachi Plaza • 2000 Sierra Point Pkwy. • Brisbane, CA 94005-1819 • (415) 589-8300

5-45

5

HM628128 Series

Read Timing Waveform

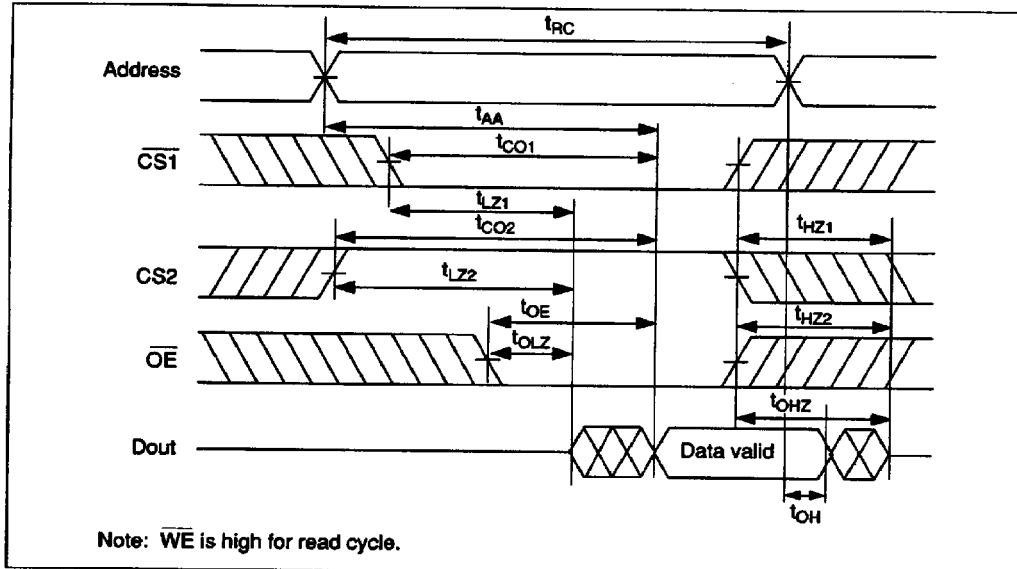

Write Cycle

Parameter	Symbol	HM628128-7		HM628128-8		HM628128-10		HM628128-12		Unit
		Min	Max	Min	Max	Min	Max	Min	Max	
Write cycle time	t_{WC}	70	—	85	—	100	—	120	—	ns
Chip selection to end of write	t_{CW}	60	—	75	—	80	—	85	—	ns
Address setup time	t_{AS}	0	—	0	—	0	—	0	—	ns
Address valid to end of write	t_{AW}	60	—	75	—	80	—	85	—	ns
Write pulse width	t_{WP}	50	—	55	—	60	—	70	—	ns
Write recovery time ^{*1}	t_{WR}	5	—	5	—	5	—	10	—	ns
		10	—	10	—	10	—	15	—	ns ^{*1}
Write to output in high-Z ^{*2}	t_{WHZ}	0	25	0	30	0	35	0	40	ns
Data to write time overlap	t_{DW}	30	—	35	—	40	—	45	—	ns
Write hold from write time	t_{DH}	0	—	0	—	0	—	0	—	ns
Output active from end of write ^{*1}	t_{OW}	5	—	5	—	5	—	5	—	ns

Notes: 1. This value is measured from CS2 going low to the end of write cycle.
2. This parameter is sampled and not 100% tested.

4496203 0024980 458

HITACHI

5-46

Hitachi America, Ltd. • Hitachi Plaza • 2000 Sierra Point Pkwy. • Brisbane, CA 94005-1819 • (415) 589-8300

Write Timing Waveform (1) (\overline{OE} Clock)

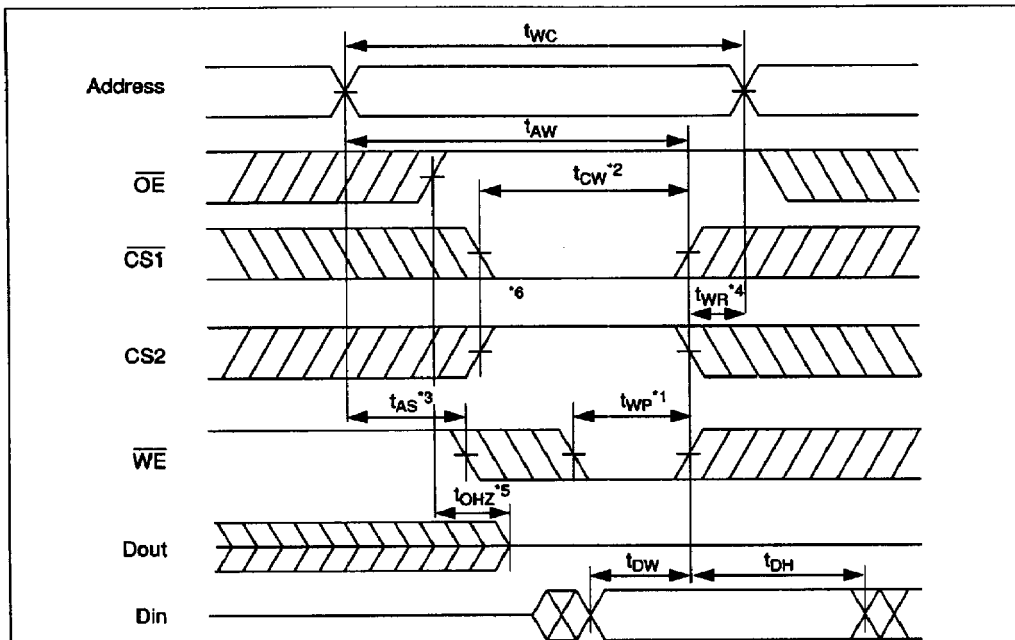

- Notes: 1. A write occurs during the overlap of a low $\overline{CS1}$, a high $\overline{CS2}$, and a low \overline{WE} . A write begin at the latest transition among $\overline{CS1}$ going low, $\overline{CS2}$ going high and \overline{WE} going low. A write end at the earliest transition among $\overline{CS1}$ going high, $\overline{CS2}$ going low and \overline{WE} going high. t_{WP} is measured from the beginning of write to the end of write.
2. t_{CW} is measure from the later of $\overline{CS1}$ going low or $\overline{CS2}$ going high to the end of write.
3. t_{AS} is measure from the address valid to the beginning of write.
4. t_{WR} is measured from the earliest of $\overline{CS1}$ or \overline{WE} going high or $\overline{CS2}$ going low to the end of write cycle.
5. During this period, I/O pins are in the output state; therefore, the input signals of the opposite phase to the outputs must not be applied.
6. If $\overline{CS1}$ goes low simultaneously with \overline{WE} going low or after \overline{WE} going low, the outputs remain in high impedance state.

5

4496203 0024981 394

HITACHI

Hitachi America, Ltd. • Hitachi Plaza • 2000 Sierra Point Pkwy. • Brisbane, CA 94005-1819 • (415) 589-8300

5-47

HM628128 Series

Write Timing Waveform (2) (\overline{OE} Fixed Low)

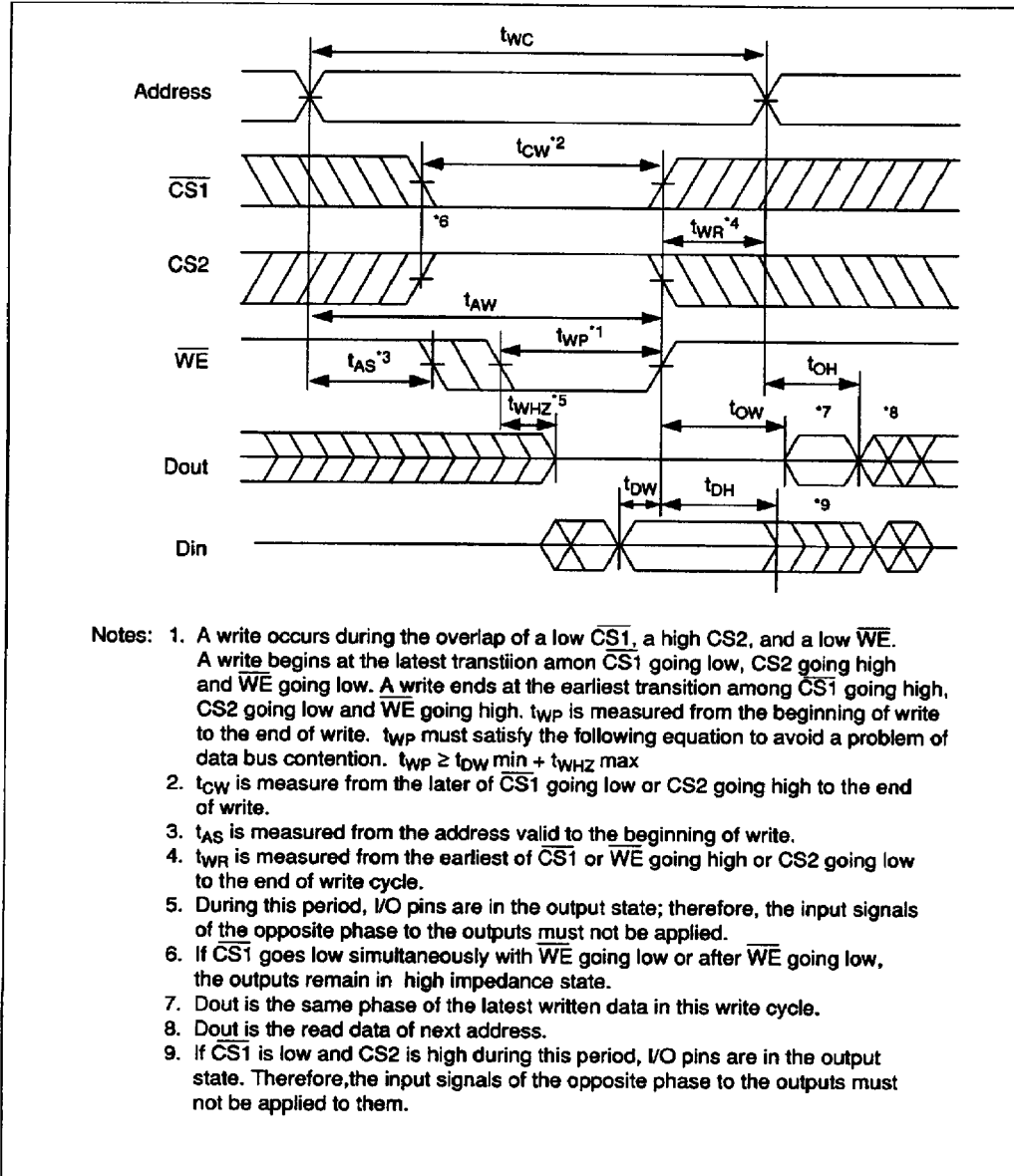

4496203 0024982 220

HITACHI

5-48

Hitachi America, Ltd. • Hitachi Plaza • 2000 Sierra Point Pkwy. • Brisbane, CA 94005-1819 • (415) 589-8300

Low V_{CC} Data Retention Characteristics ($T_a = 0$ to $+70^\circ\text{C}$)

(These characteristics are guaranteed only for L, L-L, and L-SL version.)

Parameter	Symbol	Min	Typ	Max	Unit	Test conditions ⁴	
V_{CC} for data retention	V_{DR}	2.0	—	—	V	$\overline{CS1} \geq V_{CC} - 0.2\text{V}$, $CS2 \geq V_{CC} - 0.2\text{V}$, or $0\text{V} \leq CS2 \leq 0.2\text{V}$, $V_{in} \geq$	
Data retention current	I_{CCDR}	L	—	1	50 ¹	μA	$V_{CC} = 3.0\text{V}$, $V_{in} \geq 0\text{V}$, $\overline{CS1} \geq V_{CC} - 0.2\text{V}$, $CS2 \geq V_{CC} - 0.2\text{V}$, or $0\text{V} \leq CS2 \leq 0.2\text{V}$
		L-L	—	1	30 ²	μA	
		L-SL	—	1	15 ³	μA	
Chip deselect to data retention time	t_{CDR}	0	—	—	ns	See retention waveform	
Operation recovery time	t_R	5	—	—	ms		

- Notes: 1. 20 μA max at $T_a = 0$ to 40°C
 2. 6 μA max at $T_a = 0$ to 40°C
 3. 3 μA max at $T_a = 0$ to 40°C
 4. CS2 controls address buffer, WE buffer, $\overline{CS1}$ buffer, OE buffer, and Din buffer. If CS2 controls data retention mode, V_{in} levels (address, WE, OE, $\overline{CS1}$, I/O) can be in the high impedance state. If $\overline{CS1}$ controls data retention mode, CS2 must be $CS2 \geq V_{CC} - 0.2\text{V}$ or $0\text{V} \leq CS2 \leq 0.2\text{V}$. The other input levels (address, WE, OE, I/O) can be in the high impedance state.

Low V_{CC} Data Retention Timing Waveform (1) ($\overline{CS1}$ Controlled)

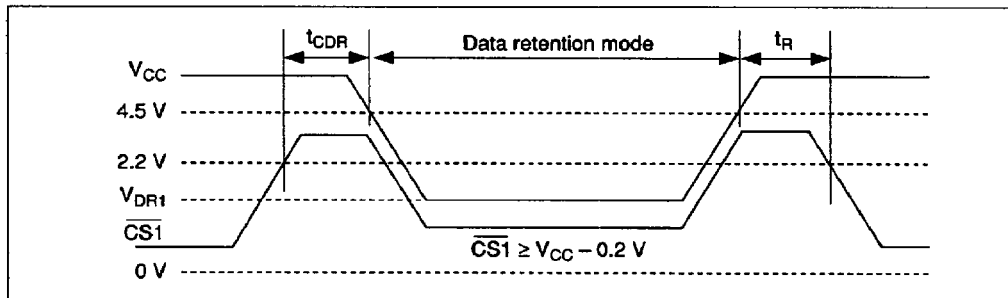

Low V_{CC} Data Retention Timing Waveform (2) ($CS2$ Controlled)

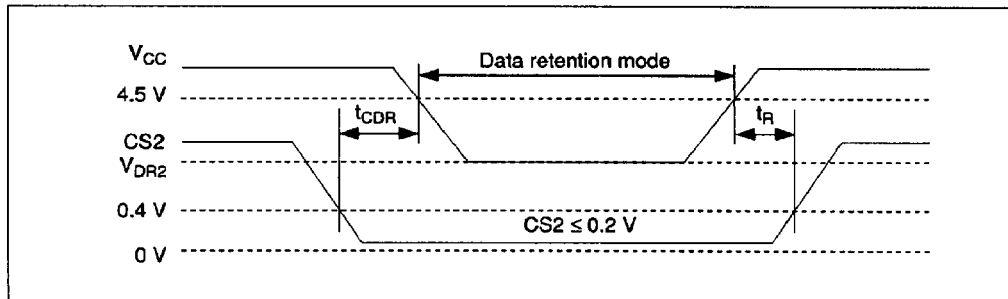

5

4496203 0024983 167

HITACHI

Hitachi America, Ltd. • Hitachi Plaza • 2000 Sierra Point Pkwy. • Brisbane, CA 94005-1819 • (415) 589-8300

5-49

HM628128 Series

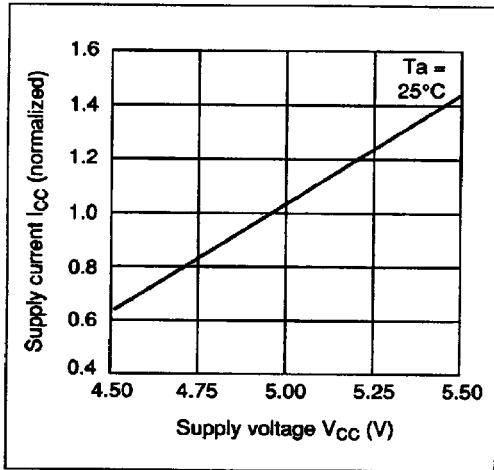

Supply Current vs. Supply Voltage (1)

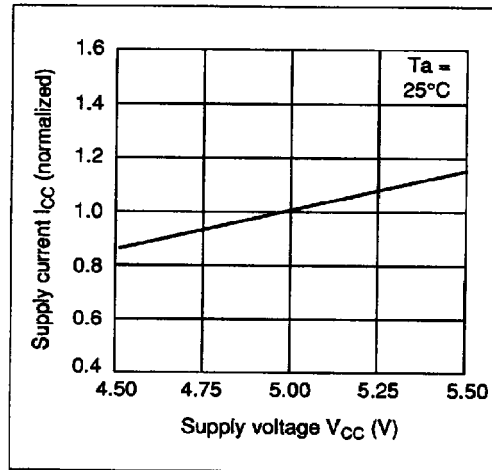

Supply Current vs. Supply Voltage (2)

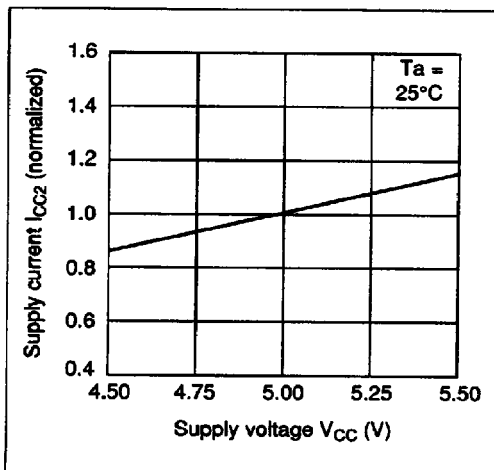

Supply Current vs. Supply Voltage (3)

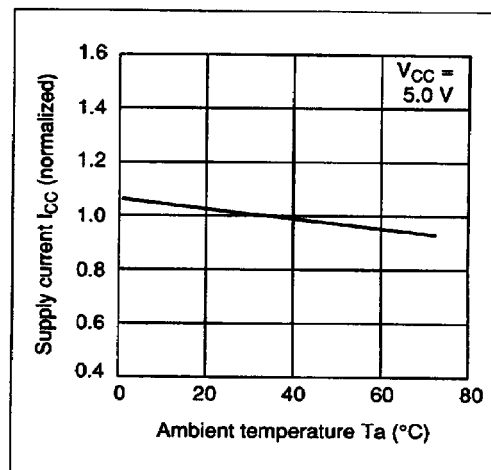

Supply Current vs. Ambient Temperature (1)

4496203 0024984 0T3

HITACHI

5-50

Hitachi America, Ltd. • Hitachi Plaza • 2000 Sierra Point Pkwy. • Brisbane, CA 94005-1819 • (415) 589-8300

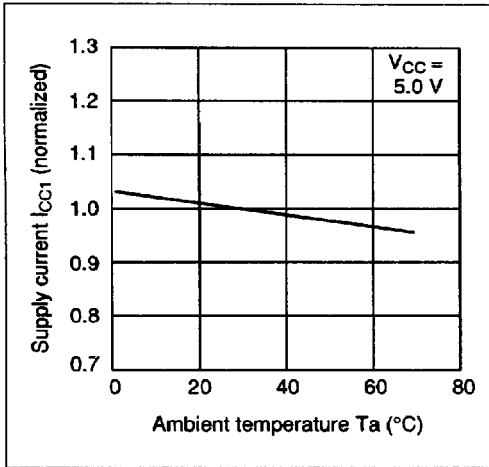

Supply Current vs. Ambient Temperature (2)

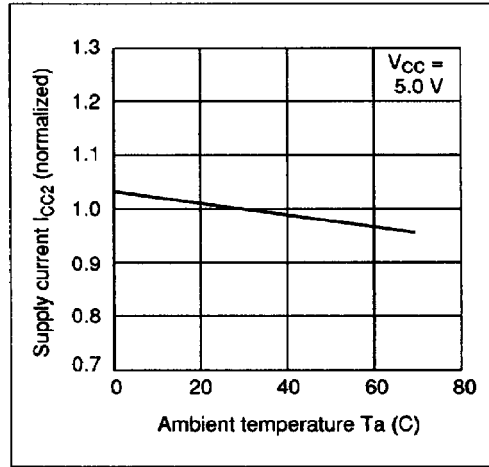

Supply Current vs. Ambient Temperature (3)

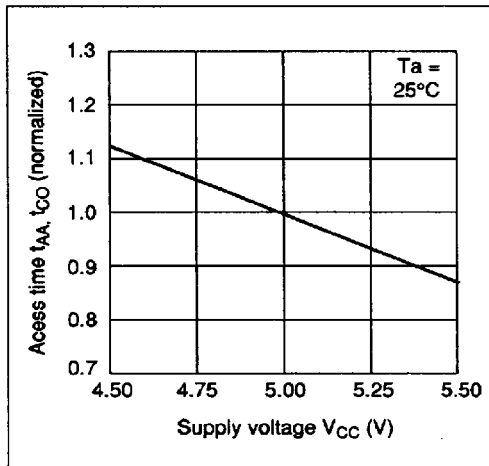

Access Time vs. Supply Voltage

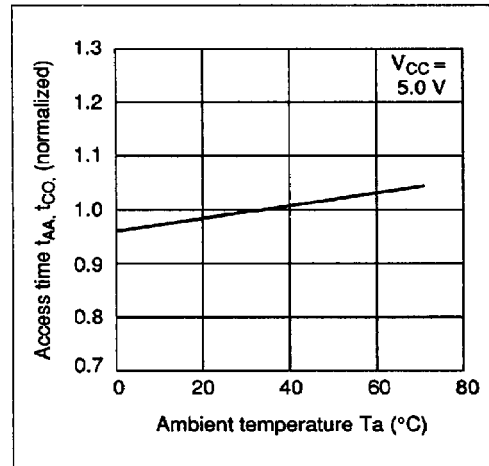

Access Time vs. Ambient Temperature

5

4496203 0024985 T3T

HITACHI

Hitachi America, Ltd. • Hitachi Plaza • 2000 Sierra Point Pkwy. • Brisbane, CA 94005-1819 • (415) 589-8300

5-51

HM628128 Series

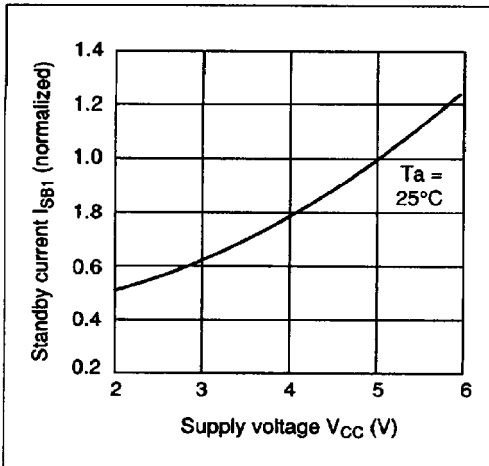

Standby Current vs. Supply Voltage

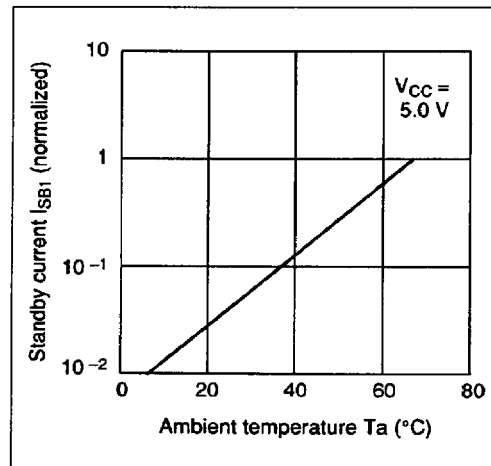

Standby Current vs. Ambient Temperature

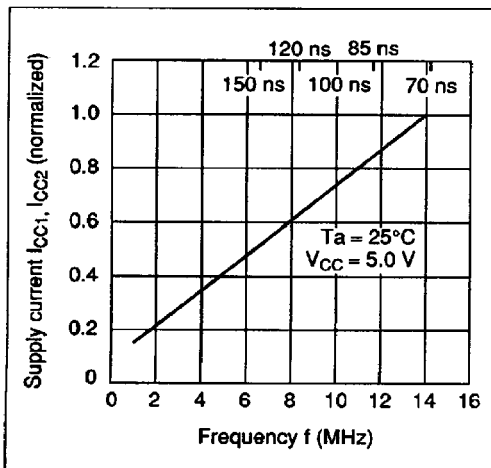

Supply Current vs. Frequency (Read)

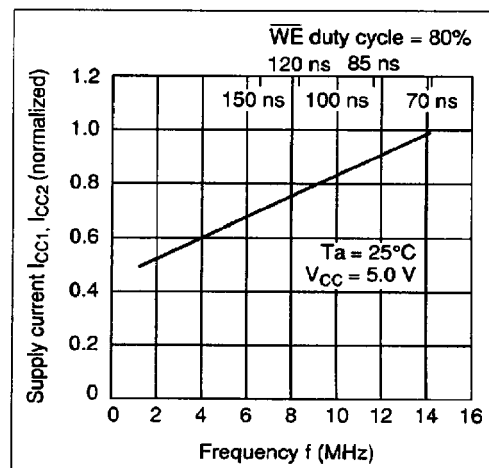

Supply Current vs. Frequency (Write)

4496203 0024986 976

HITACHI

5-52

Hitachi America, Ltd. • Hitachi Plaza • 2000 Sierra Point Pkwy. • Brisbane, CA 94005-1819 • (415) 589-8300

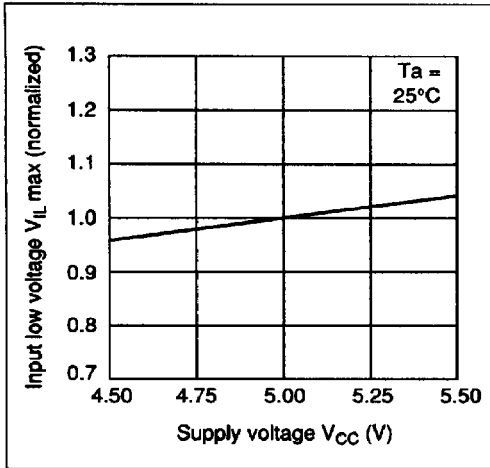

Input Low Voltage vs. Supply Voltage

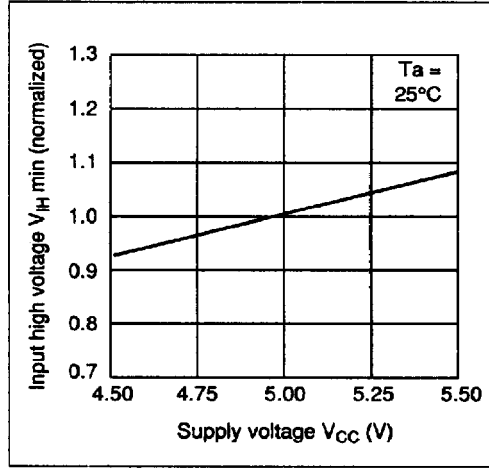

Input High Voltage vs. Supply Voltage

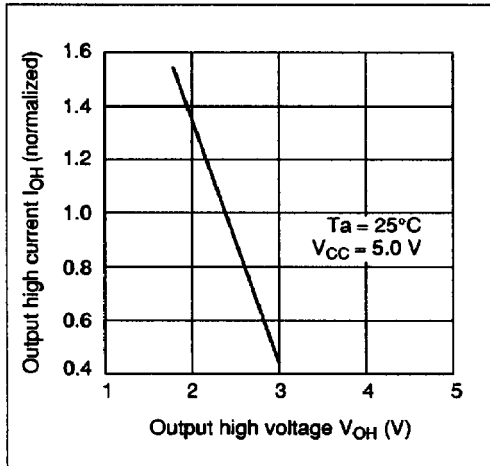

Output High Current vs. Output High Voltage

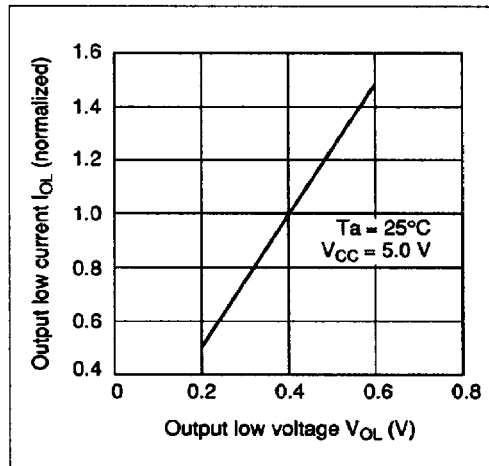

Output Low Current vs. Output Low Voltage

5

4496203 0024987 802 HITACHI

Hitachi America, Ltd. • Hitachi Plaza • 2000 Sierra Point Pkwy. • Brisbane, CA 94005-1819 • (415) 589-8300

5-53

HM628128 Series

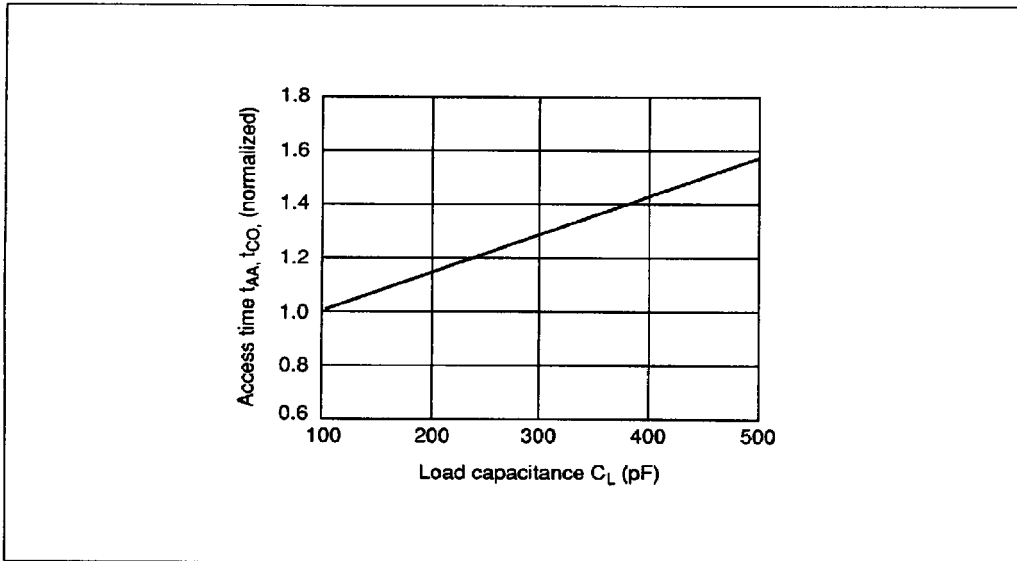

Access Time vs. Load Capacitance

■ 4496203 0024988 749 ■

HITACHI

5-54

Hitachi America, Ltd. • Hitachi Plaza • 2000 Sierra Point Pkwy. • Brisbane, CA 94005-1819 • (415) 589-8300