

## 9-Line SCSI Terminator

The 9-channel IMP5219 SCSI terminator is part of IMP's family of high-performance SCSI terminators that deliver true UltraSCSI performance. The BiCMOS design offers superior performance over first generation linear regulator/resistor based terminators.

IMP's new architecture employs high-speed adaptive elements for each channel, thereby providing the fastest response possible - typically 35MHz, which is 100 times faster than the older linear regulator terminator approach. The bandwidth of terminators based on the older regulator/resistor terminator architecture is limited to 500kHz since a large output stabilization capacitor is required. The IMP architecture eliminates the external output compensation capacitor and the need for transient output capacitors while maintaining pin compatibility with first generation designs. Reduced component count is inherent with the IMP5219.

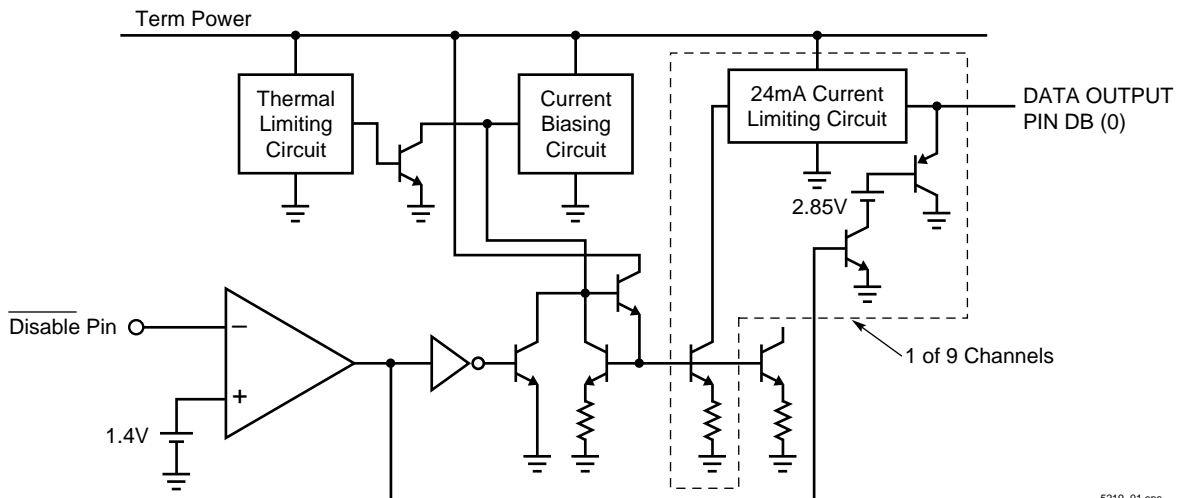
The IMP5219 architecture tolerates marginal system designs. A key improvement offered by the IMP5219 lies in its ability to insure reliable, error-free communications even in systems which do not adhere to recommended SCSI hardware design guidelines, such as improper cable lengths and impedance. Frequently, this situation is not controlled by the peripheral or host designer.

For portable and configurable peripherals, the IMP5219 can be placed in a sleep mode with an active LOW disable signal. Quiescent current is typically 375 $\mu$ A and output are in a high impedance state when disabled.

### Key Features

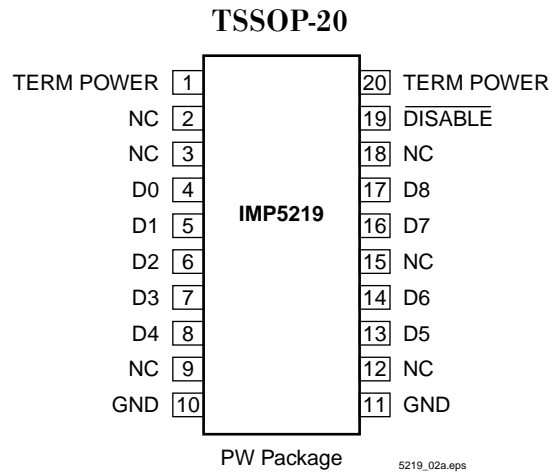
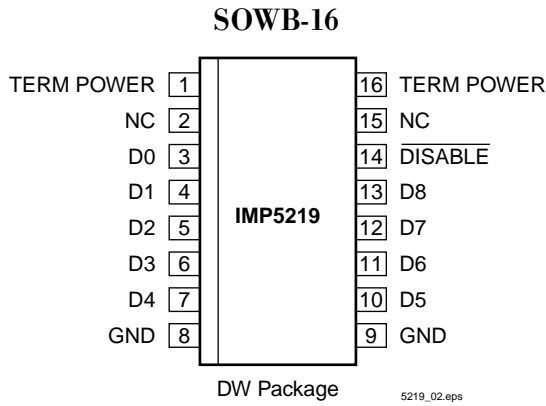
- ◆ Ultra-Fast response for Fast-20 SCSI applications
- ◆ Hot swap compatible
- ◆ 35MHz channel bandwidth
- ◆ 3.5V operation
- ◆ Less than 3pF output capacitance
- ◆ Sleep-mode current less than 375 $\mu$ A
- ◆ Thermally self limiting
- ◆ No external compensation capacitors
- ◆ Implements 8-bit or 16-bit (wide) applications
- ◆ Compatible with active negation drivers (60ma/channel)
- ◆ Compatible with passive and active terminations
- ◆ Approved for use with SCSI 1, 2, 3 and UltraSCSI

### Block Diagrams



5219\_01.eps

## Pin Configuration



## Ordering Information

Part Number	Temperature Range	Package
IMP5219CDW	0°C to 125°C	16-pin Plastic SOWB
IMP5219CDWT	0°C to 125°C	Tape and Reel, 16-pin Plastic SOWB
IMP5219CPW	0°C to 125°C	20-pin Plastic TSSOP
IMP5219CPWT	0°C to 125°C	Tape and Reel, 20-pin Plastic TSSOP

5219\_011.ai3

## Absolute Maximum Ratings<sup>1</sup>

Continuous Termination Voltage ..... 10V  
 Continuous Output Voltage Range ..... 0V to 5.5V  
 Continuous Disable Voltage Range ..... 0V to 5.5V  
 Operating Junction Temperature ..... 0°C to 125°C  
 Storage Temperature Range ..... -65°C to 150°C  
 Lead Temperature (Soldering, 10 sec.) ..... 300°C

*Note: 1. Exceeding these ratings could cause damage to the device. All voltages are with respect to Ground. Currents are positive into, negative out of the specified terminal.*

## Thermal Data

DW Package:

Thermal Resistance Junction-to-Ambient,  $\theta_{JA}$  ..... 95°C/W

PW Package:

Thermal Resistance Junction-to-Ambient,  $\theta_{JA}$  ..... 144°C/W

Junction Temperature Calculation:  $T_J = T_A + (P_D \times \theta_{JA})$ .

The  $\theta_{JA}$  numbers are guidelines for the thermal performance of the device/pc-board system. All of the ambient airflow is assumed.

## Recommended Operating Conditions<sup>2</sup>

Parameter	Symbol	Min	Typ	Max	Units
TermPwr Voltage	$V_{\text{TERM}}$	3.5		5.5	V
High Level Disable Input Voltage	$V_{\text{IH}}$	2		$V_{\text{TERM}}$	V
Low Level Disable Input Voltage	$V_{\text{IL}}$	0		0.8	V
Operating Junction Temperature Range		0		125	°C

Note: 2. Recommended operating conditions indicate the range over which the device is functional.

5219\_102.eps

## Electrical Characteristics

Unless otherwise specified, these specifications apply at an ambient operating temperature of  $T_A = 25^\circ\text{C}$ . TermPwr = 4.75V. Low duty cycle pulse testing techniques are used which maintain junction and case temperatures equal to the ambient temperature.

Parameter	Symbol	Conditions	Min	Typ	Max	Units
Output High Voltage	$V_{\text{OUT}}$		2.65	2.85		V
TermPwr Supply Current	$I_{\text{CC}}$	All data lines = Open		6	9	mA
		All data lines = 0.5V		215	225	mA
		$\overline{\text{Disable}} < 0.8\text{V}$		375		$\mu\text{A}$
Output Current	$I_{\text{OUT}}$	$V_{\text{OUT}} = 0.5\text{V}$	-21	-23	-24	mA
Disable Input Current	$I_{\text{IN}}$	$\overline{\text{Disable}} = 4.75\text{V}$		10		nA
		$\overline{\text{Disable}} = 0\text{V}$		-90		$\mu\text{A}$
Output Leakage Current	$I_{\text{OL}}$	$\overline{\text{Disable}} = 0.8\text{V}, V_{\text{O}} = 0.5\text{V}$		10		nA
Capacitance in Disabled Mode	$C_{\text{OUT}}$	$V_{\text{OUT}} = 0\text{V}$ , Frequency = 1MHz		3		pF
Channel Bandwidth	BW			35		MHz
Termination Sink Current, per Channel	$I_{\text{SINK}}$	$V_{\text{OUT}} = 4\text{V}$		60		mA

5219\_103.eps

## Application Information

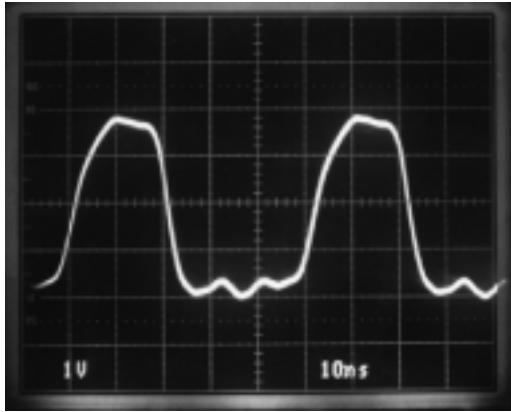


Figure 1. Receiving Waveform – 20MHz

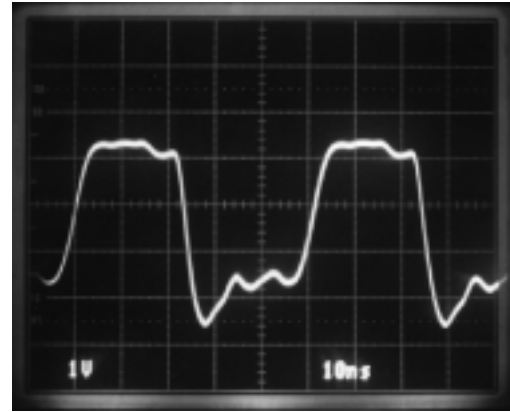


Figure 2. Driving Waveform – 20MHz

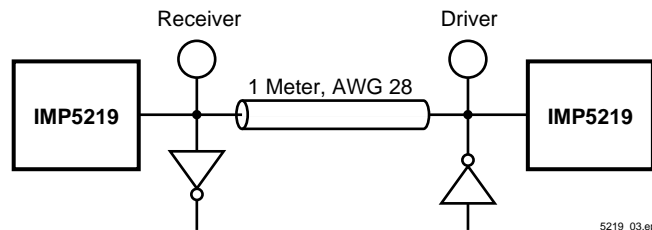


Figure 3.

### IMP5219 Maximizes Line Current

Cable transmission theory suggests to optimize signal speed and quality, the termination should act both as an ideal voltage reference when the line is released (deasserted) and as an ideal current source when the line is active (asserted). Common active terminators which consist of linear regulators in series with resistors (typically 110Ω) are a compromise. With conventional linear terminators as the line voltage increases the amount of current decreases linearly by the equation;

$$\frac{(V_{REF} - V_{LINE})}{R} = I$$

The IMP5219, with its unique new architecture, applies the maximum amount of current regardless of line voltage until the termination high threshold (2.85V) is reached.

Acting as a near ideal line terminator, the IMP5219 closely reproduces the optimum case when the device is enabled. To enable the device the `Disable` pin must be driven HIGH or left Open. When enabled, quiescent current is 6mA and the device will respond to line demands by delivering 24mA on assertion and by imposing 2.85V on de-assertion.

### Disable/Sleep Mode

Disable mode places the device in a sleep state, where quiescent current typically 375μA. When disabled, all outputs are in a high impedance state and output capacitance is a low 3pF. Sleep mode can be used for power conservation or to remove the terminator from the SCSI chain.

An additional feature of the IMP5219 is its compatibility with active negation drivers.

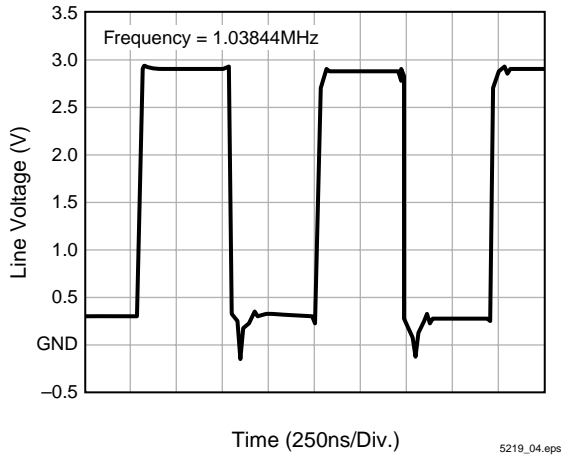
Table 1. Power Up/ Power Down Function Table

Disable	Outputs	Quiescent Current
H	Enabled	6mA
L	Disable/High Impedance	375μA
Open	Enabled	6mA

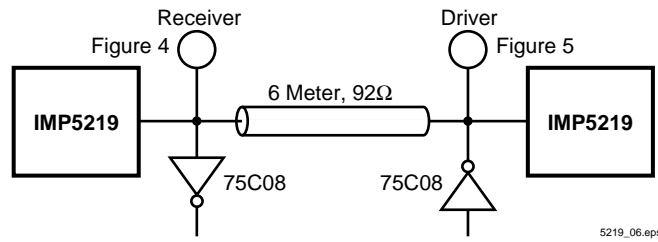
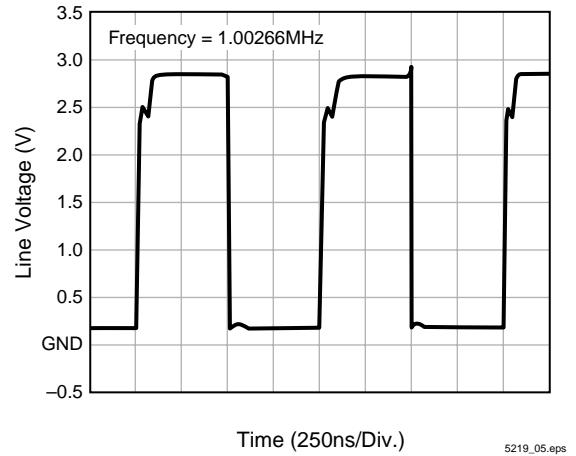
5219\_104.eps

## Typical Characteristics

**Figure 4. Receiving Waveform**



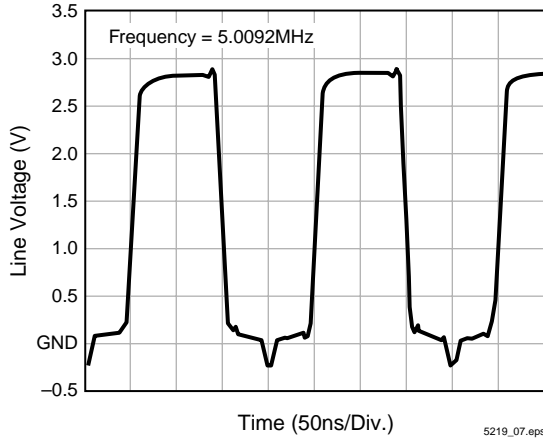
**Figure 5. Driving Waveform**



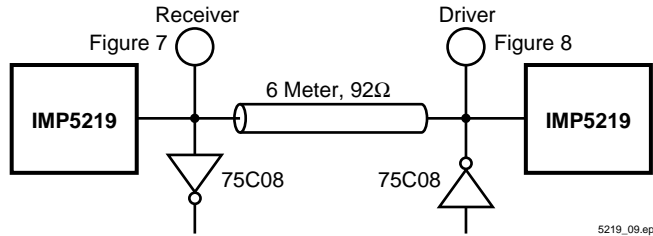
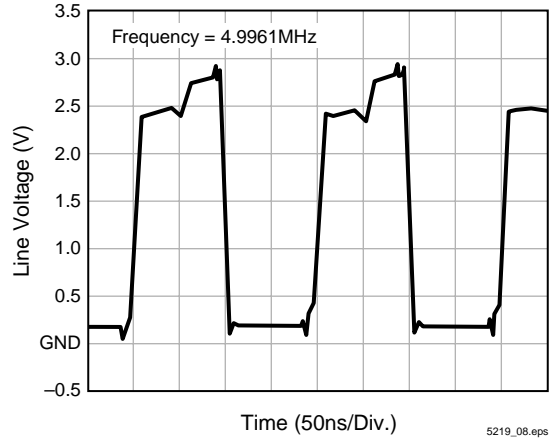
**Figure 6. End-Driven Cable**

## Typical Characteristics

**Figure 7. Receiving Waveform**

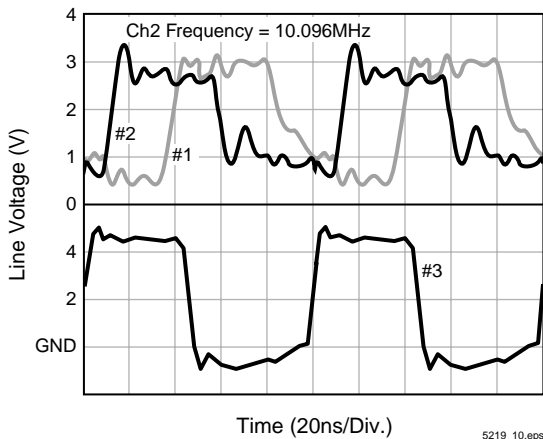


**Figure 8. Driving Waveform**

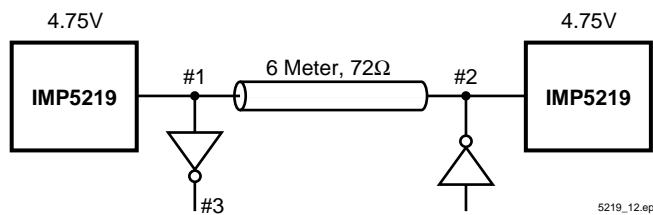
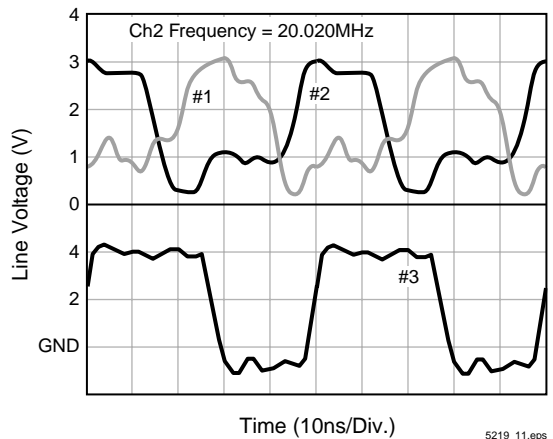


**Figure 9. End-Driven Cable**

**Figure 10. 10MHz Waveform**



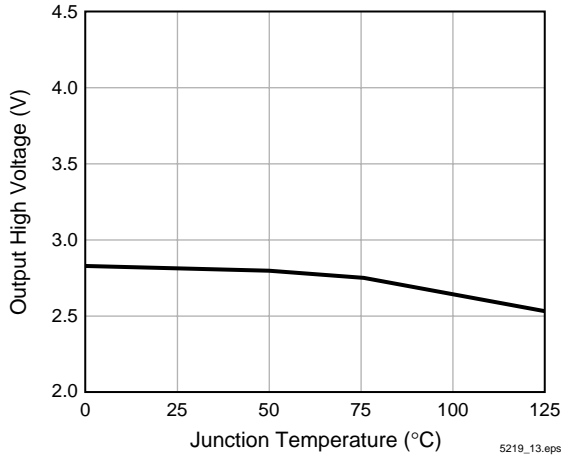
**Figure 11. 20MHz Waveform**



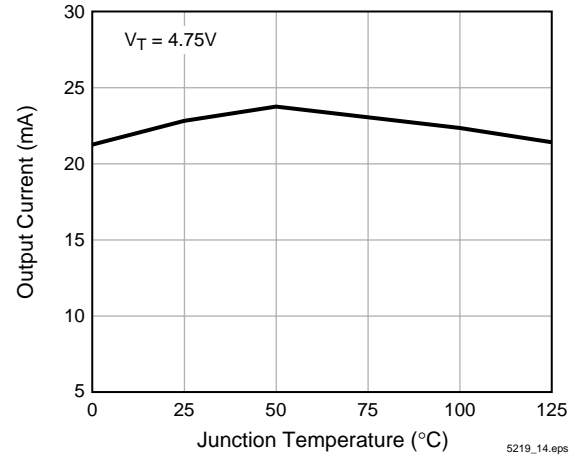
**Figure 12. End-Driven Cable**

## Typical Characteristics

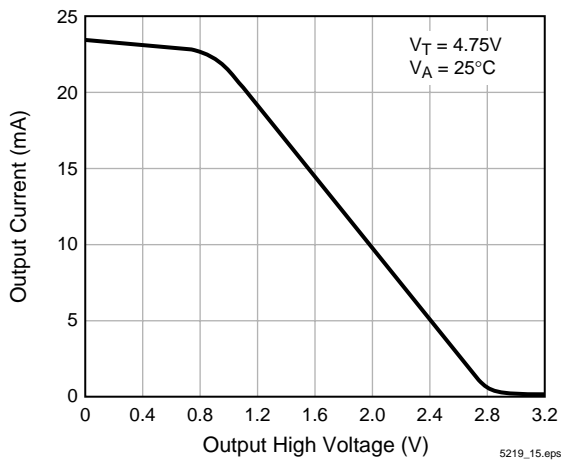
**Figure 13. Output High Voltage vs. Junction Temperature**



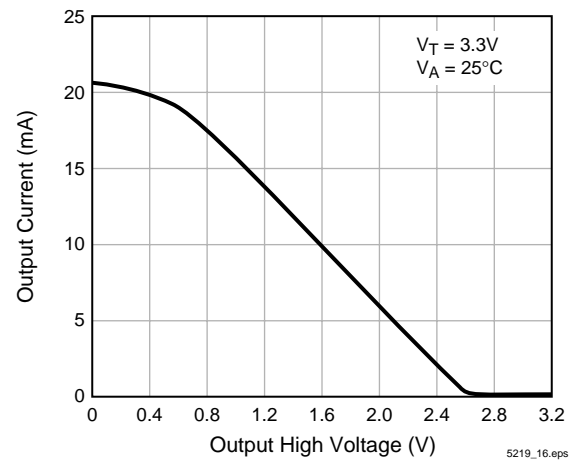
**Figure 14. Output Current vs. Junction Temperature**



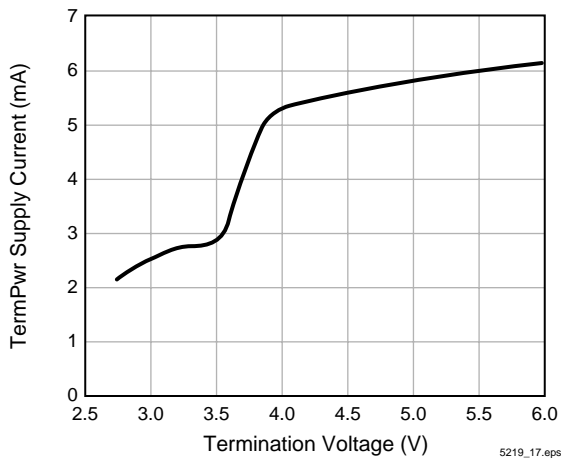
**Figure 15. Output Current vs. Output High Voltage**



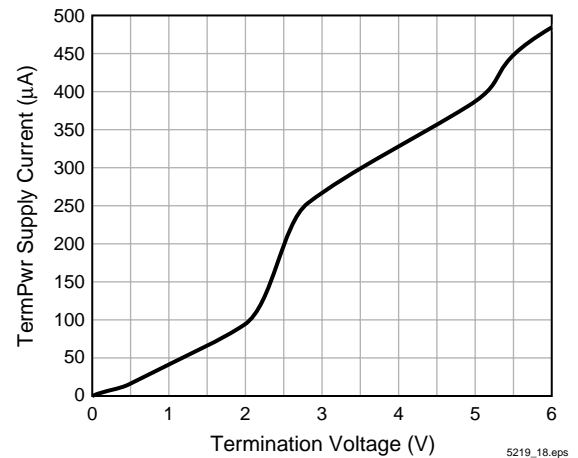
**Figure 16. Output Current vs. Output High Voltage**



**Figure 17. TermPwr Supply Current vs. Termination Voltage**

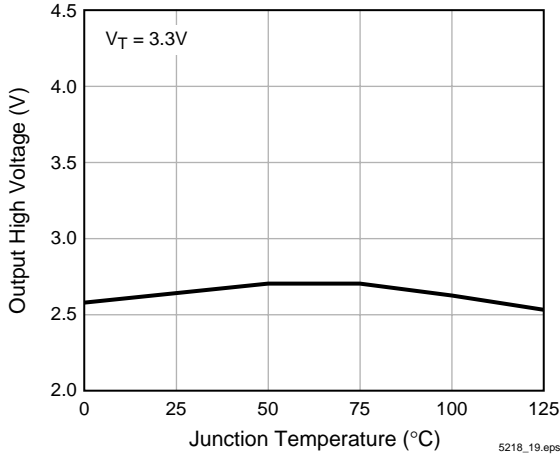


**Figure 18. TermPwr Supply Current vs. Termination Voltage (Disabled)**

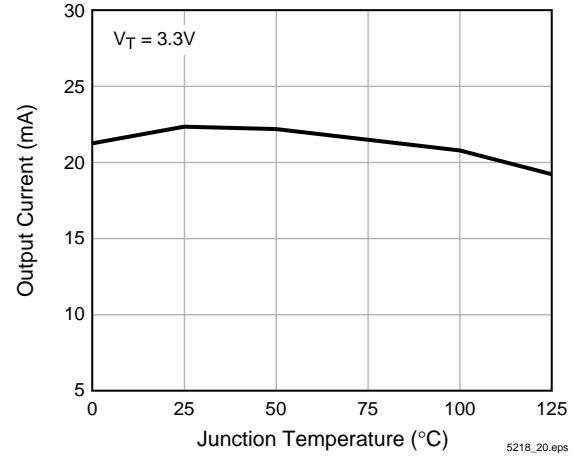


## Typical Characteristics

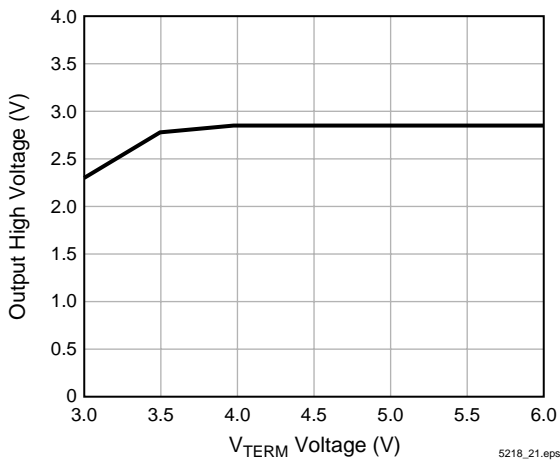
**Figure 19. Output High Voltage vs. Junction Temperature**



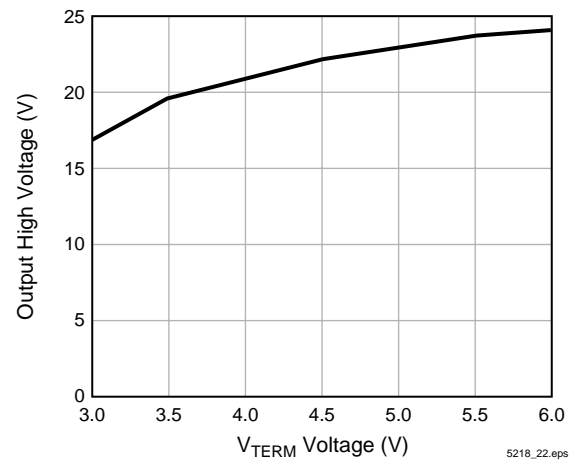
**Figure 20. Output Current vs. Junction Temperature**



**Figure 21. Output High Voltage vs. Termination Voltage**



**Figure 22. Output Current vs. Termination Voltage**





## Typical Characteristics

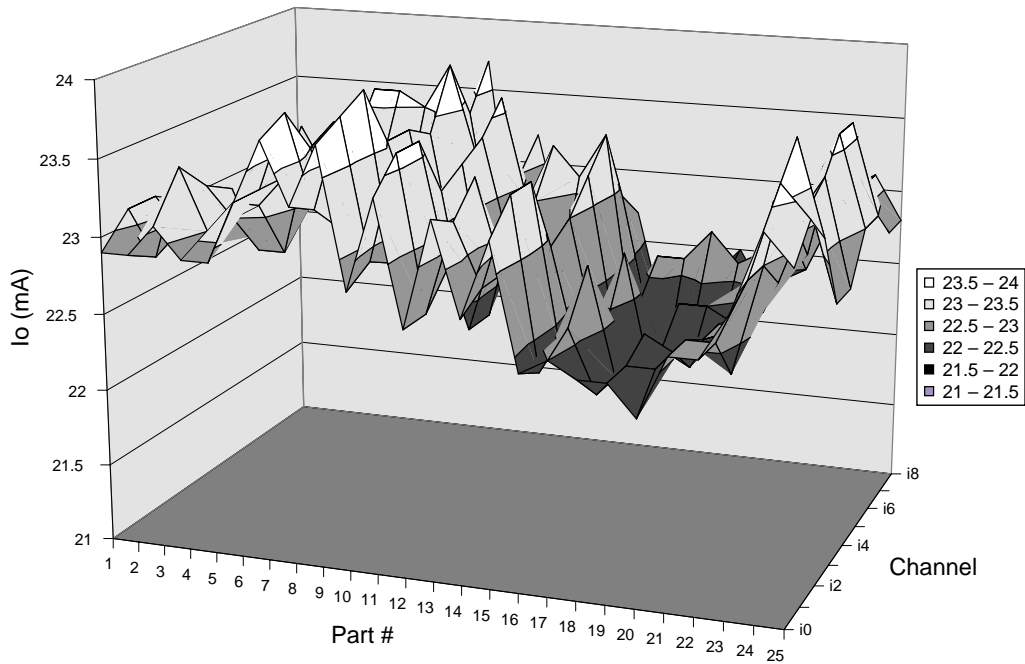
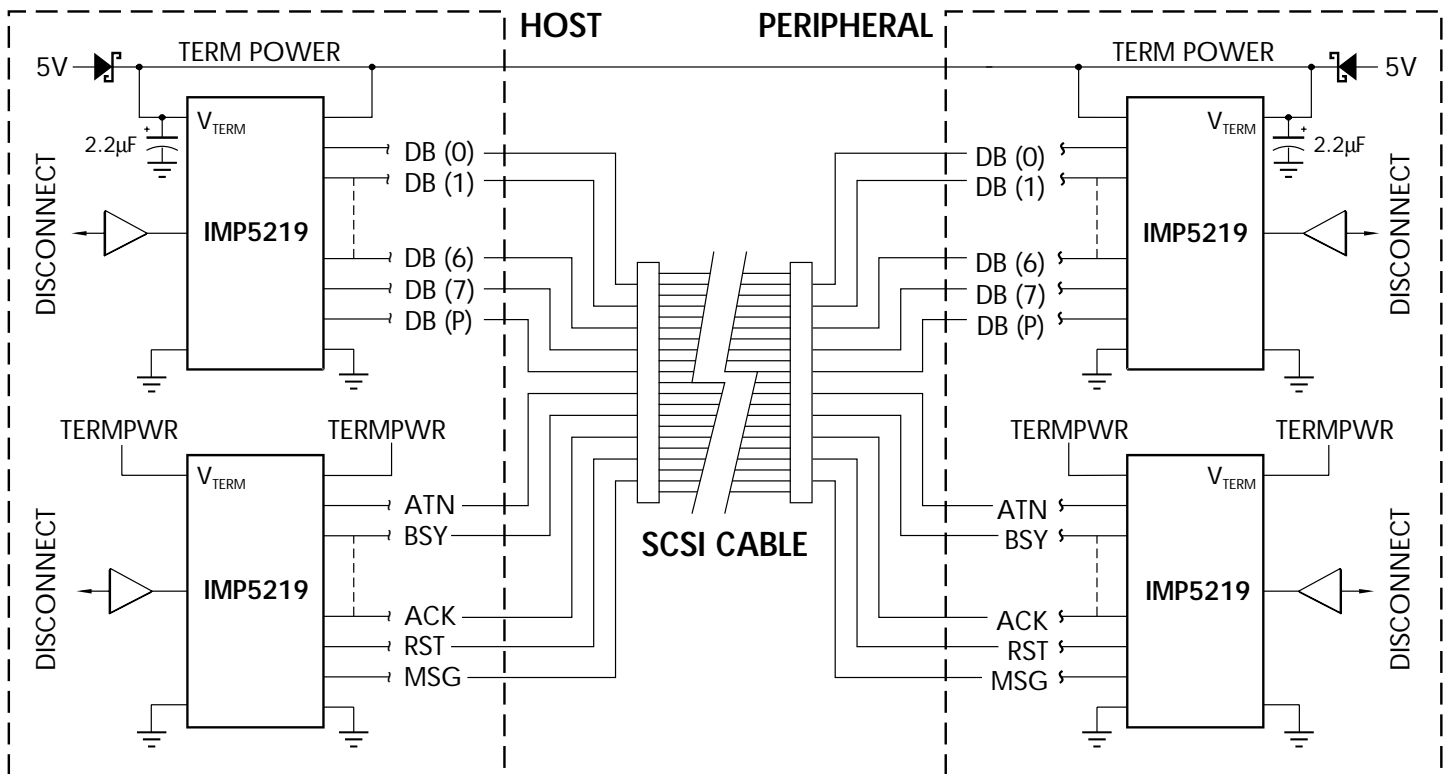


Figure 23. Output Current Matching Channel to Channel

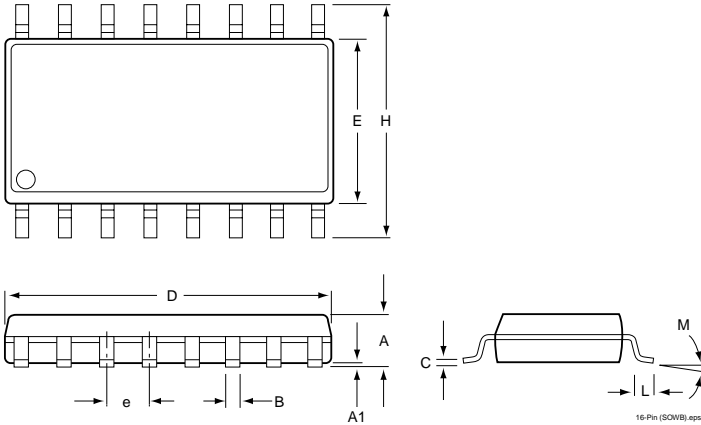


Note: Add third IMP5219 for 16-bit SCSI

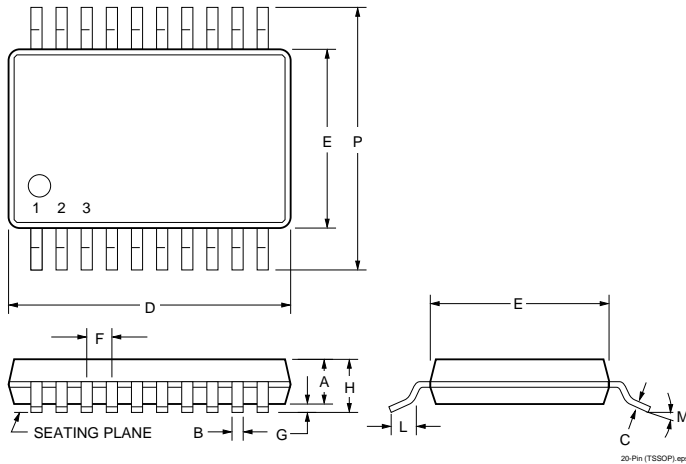
Figure 24. 8-Bit SCSI System Application

## Package Dimensions

### SOWB (16-Pin)



### TSSOP (20-Pin)



	Inches		Millimeters	
	Min	Max	Min	Max
<b>SOWB (16-Pin)</b>				
A	0.093	0.104	2.35	2.65
A1	0.004	0.012	0.10	0.30
B	0.013	0.020	0.33	0.51
C	0.009	0.013	0.23	0.32
D	0.398	0.413	10.10	10.50
E	0.291	0.299	7.40	7.60
e	0.05 BSC		1.27 BSC	
H	0.394	0.419	10.00	10.65
L	0.016	0.050	0.40	1.27
M	0°	8°	0°	8°
*LC	—	0.004	—	0.10
<b>TSSOP (20-Pin)</b>				
A	0.033	0.037	—	0.90
B	0.007	0.012	0.18	0.30
C	0.0035	0.008	0.90	0.180
D	0.252	0.260	6.40	6.60
E	0.169	0.177	4.30	4.48
F	0.025 BSC		0.65 BSC	
G	0.002	0.005	0.05	0.15
H	—	0.0433	—	1.10
L	0.020	0.028	0.50	0.70
M	0°	8°	0°	8°
P	0.246	0.256	6.25	6.50
*LC	—	0.004	—	0.10

\* Lead Coplanarity

5218\_106.at3