

## 3 AMP POSITIVE ADJUSTABLE VOLTAGE REGULATOR

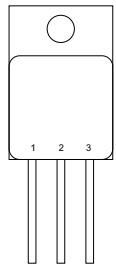

Pin 1 – ADJ.  
 Pin 2 –  $V_{OUT}$   
 Case –  $V_{IN}$

**Q Package – TO254**

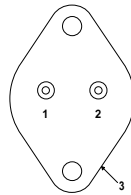

Pin 1 – ADJ.  
 Pin 2 –  $V_{IN}$   
 Case –  $V_{OUT}$

**K Package – TO-3**

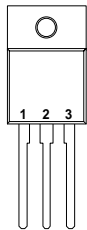

Pin 1 – ADJ.  
 Pin 2 –  $V_{OUT}$   
 Pin 3 –  $V_{IN}$   
 Case –  $V_{OUT}$

**V Package – TO-218**

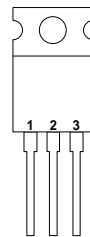

Pin 1 – ADJ.  
 Pin 2 –  $V_{OUT}$   
 Pin 3 –  $V_{IN}$   
 Case –  $V_{OUT}$

**T Package – TO-220**

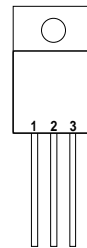

Pin 1 – ADJ.  
 Pin 2 –  $V_{OUT}$   
 Pin 3 –  $V_{IN}$   
 Case –  $V_{OUT}^*$

**G Package – TO-257**  
**IG Package - TO-257**  
 \* Isolated case on IG Package

### FEATURES

- OUTPUT VOLTAGE RANGE OF 1.25 TO 35V
- 1% OUTPUT VOLTAGE TOLERANCE (-A VERSIONS)
- 0.3% LOAD REGULATION
- 0.01%/V LINE REGULATION
- COMPLETE SERIES OF PROTECTIONS:
  - CURRENT LIMITING
  - THERMAL SHUTDOWN
  - SOA CONTROL

### Order Information

Part Number	K-Pack (TO-3)	G/IG-Pack (TO-257)	T-Pack (TO-220)	V-Pack (TO-218)	Q-Pack (TO-254)	Temp. Range	Note:
IP150A	✓	✓			✓	-55 to +150°C	To order, add the package identifier to the part number. eg. IP150AQ
IP150	✓	✓			✓	"	
LM150	✓				✓	-55 to +150°C	
IP350A	✓		✓	✓		0 to 125°C	
IP350	✓		✓	✓		"	

### ABSOLUTE MAXIMUM RATINGS ( $T_{case} = 25^{\circ}C$ unless otherwise stated)

$V_{I-O}$	Input - Output Differential Voltage	35V
$P_D$	Power Dissipation	Internally limited
$T_J$	Operating Junction Temperature Range	See Table Above
$T_{STG}$	Storage Temperature	-65 to 150°C
$T_L$	Lead Temperature (Soldering, 10 sec.)	300°C

Parameter	Test Conditions	IP150A			LM150 IP150			Units
		Min.	Typ.	Max.	Min.	Typ.	Max.	
$V_{REF}$ Reference Voltage	$I_{OUT} = 10\text{mA}$	1.238	1.25	1.262				V
	$I_{OUT} = 10\text{mA to } 3\text{A}$ $V_{IN} - V_{OUT} = 3\text{V to } 35\text{V}$ $P \leq 30\text{W}$ $T_J = -55 \text{ to } +150^\circ\text{C}$	1.225	1.250	1.270	1.200	1.250	1.300	V
$\frac{\Delta V_{OUT}}{\Delta I_{OUT}}$ Line Regulation 1	$V_{IN} - V_{OUT} = 3\text{V to } 35\text{V}$ $T_J = -55 \text{ to } +150^\circ\text{C}$		0.005	0.010		0.005	0.010	% / V
			0.020	0.050		0.020	0.050	
$\frac{\Delta V_{OUT}}{\Delta I_{OUT}}$ Load Regulation 1	$I_{OUT} = 10\text{mA to } 3\text{A}$ $V_{OUT} \leq 5\text{V}$ $T_J = -55 \text{ to } +150^\circ\text{C}$		5	15		5	15	mV
			15	50		20	50	
	$I_{OUT} = 10\text{mA to } 3\text{A}$ $V_{OUT} \geq 5\text{V}$ $T_J = -55 \text{ to } +150^\circ\text{C}$		0.1	0.3		0.1	0.3	%
			0.3	1		0.3	1	
Thermal Regulation	$t_p = 20\text{ms}$ $T_A = 25^\circ\text{C}$		0.002	0.010		0.002	0.010	%/W
Ripple Rejection	$V_{OUT} = 10\text{V}$ $f = 120\text{Hz}$ $T_J = -55 \text{ to } +150^\circ\text{C}$	$C_{ADJ} = 0$		65		65		dB
		$C_{ADJ} = 10\mu\text{F}$	66	86	66	86		dB
$I_{ADJ}$ Adjust Pin Current	$T_J = -55 \text{ to } +150^\circ\text{C}$		50	100		50	100	$\mu\text{A}$
$\Delta I_{ADJ}$ Adjust Pin Current Change	$I_{OUT} = 10\text{mA to } 3\text{A}$ $V_{IN} - V_{OUT} = 3\text{V to } 35\text{V}$ $T_J = -55 \text{ to } +150^\circ\text{C}$		0.2	5		0.2	5	$\mu\text{A}$
$I_{MIN}$ Minimum Load Current	$V_{IN} - V_{OUT} = 35\text{V}$ $T_J = -55 \text{ to } +150^\circ\text{C}$		3.5	5		3.5	5	mA
$I_{CL}$ Current Limit	$V_{IN} - V_{OUT} \leq 10\text{V}$ $T_J = -55 \text{ to } +150^\circ\text{C}$	3	4.5		3	4.5		A
	$V_{IN} - V_{OUT} = 30\text{V}$	0.3	1		0.3	1		A
$\frac{\Delta V_{OUT}}{\Delta \text{TEMP}}$ Temperature Stability	$T_J = -55 \text{ to } +150^\circ\text{C}$		1	2		1		%
$\frac{\Delta V_{OUT}}{\Delta \text{TIME}}$ Long Term Stability	$T_A = 125^\circ\text{C}$ $t = 1000 \text{ Hrs}$		0.3	1		0.3	1	%
$e_n$ RMS Output Noise (% of $V_{OUT}$ )	$f = 10 \text{ Hz to } 10 \text{ kHz}$ $T_A = 25^\circ\text{C}$		0.001			0.001		%
$R_{\theta JC}$ Thermal Resistance Junction to Case	K Package (TO-3)		1.5			1.5		$^\circ\text{C/W}$
	G Package (TO-257)		3	4		3	4	

- 1) Regulation is measured at constant junction temperature, using pulse testing at a low duty cycle. Changes in output voltage due to heating effects are covered under thermal regulation specifications. Load regulation is measured from the bottom of the package for the TO-3 package and on the back of the heat tab for the TO-218, TO-220 and TO-257 packages.
- 2) Test Conditions unless otherwise stated:  $V_{IN} - V_{OUT} = 5\text{V}$ ,  $T_J = 25^\circ\text{C}$ ,  $I_{OUT} = 1.5\text{A}$ .  
Although power dissipation is internally limited, these specifications apply for dissipations of 30W for the TO-3, TO-218 and TO-257 packages, and 25W for the TO-220 package;  $I_{MAX} = 3\text{A}$ .

Parameter	Test Conditions	IP350A			IP350			Units
		Min.	Typ.	Max.	Min.	Typ.	Max.	
$V_{REF}$ Reference Voltage	$I_{OUT} = 10mA$	1.238	1.25	1.262				V
	$I_{OUT} = 10mA$ to 3A $V_{IN} - V_{OUT} = 3V$ to 35V $P \leq 30W$ $T_J = 0$ to +125°C	1.225	1.250	1.270	1.200	1.250	1.300	V
$\frac{\Delta V_{OUT}}{\Delta I_{OUT}}$ Line Regulation 1	$V_{IN} - V_{OUT} = 3V$ to 35V $T_J = 0$ to +125°C		0.005	0.010		0.005	0.030	% / V
	$T_J = 0$ to +125°C		0.020	0.050		0.020	0.070	
$\frac{\Delta V_{OUT}}{\Delta I_{OUT}}$ Load Regulation 1	$I_{OUT} = 10mA$ to 3A $V_{OUT} \leq 5V$ $T_J = 0$ to +125°C		5	15		5	25	mV
	$T_J = 0$ to +125°C		15	50		20	70	
	$I_{OUT} = 10mA$ to 3A $V_{OUT} \geq 5V$ $T_J = 0$ to +125°C		0.1	0.3		0.1	0.5	%
	$T_J = 0$ to +125°C		0.3	1		0.3	1.5	
Thermal Regulation	$t_p = 20ms$ $T_A = 25^\circ C$		0.002	0.010		0.002	0.030	%/W
Ripple Rejection	$V_{OUT} = 10V$ $C_{ADJ} = 0$ $f = 120Hz$		65			65		dB
	$C_{ADJ} = 10\mu F$ $T_J = 0$ to +125°C	66	86		66	86		dB
$I_{ADJ}$ Adjust Pin Current	$T_J = 0$ to +125°C		50	100		50	100	$\mu A$
$\Delta I_{ADJ}$ Adjust Pin Current Change	$I_{OUT} = 10mA$ to 3A $V_{IN} - V_{OUT} = 3V$ to 35V $T_J = 0$ to +125°C		0.2	5		0.2	5	$\mu A$
$I_{MIN}$ Minimum Load Current	$V_{IN} - V_{OUT} = 35V$ $T_J = 0$ to +125°C		3.5	5		3.5	10	mA
$I_{CL}$ Current Limit	$V_{IN} - V_{OUT} \leq 10V$ $T_J = 0$ to +125°C	3	4.5		3	4.5		A
	$V_{IN} - V_{OUT} = 30V$	0.25	1		0.25	1		A
$\frac{\Delta V_{OUT}}{\Delta TEMP}$ Temperature Stability	$T_J = 0$ to +125°C		1	2		1		%
$\frac{\Delta V_{OUT}}{\Delta TIME}$ Long Term Stability	$T_A = 125^\circ C$ $t = 1000$ Hrs		0.3	1		0.3	1	%
$e_n$ RMS Output Noise (% of $V_{OUT}$ )	$f = 10$ Hz to 10 kHz $T_A = 25^\circ C$		0.001			0.001		%
$R_{\theta JC}$ Thermal Resistance Junction to Case	K Package (TO-3)		1.5			1.5		°C/W
	T Package (TO-220)		3	4		3	4	
	V Package (TO-218)		1.5			1.5		

- 1) Regulation is measured at constant junction temperature, using pulse testing at a low duty cycle. Changes in output voltage due to heating effects are covered under thermal regulation specifications. Load regulation is measured from the bottom of the package for the TO-3 package and on the back of the heat tab for the TO-218, TO-220 and TO-257 packages.
- 2) Test Conditions unless otherwise stated:  $V_{IN} - V_{OUT} = 5V$ ,  $T_J = 25^\circ C$ ,  $I_{OUT} = 1.5A$ .  
 Although power dissipation is internally limited, these specifications apply for dissipations of 30W for the TO-3, TO-218 and TO-257 packages, and 25W for the TO-220 package;  $I_{MAX} = 3A$ .

**TYPICAL PERFORMANCE CHARACTERISTICS**

**Load Regulation**

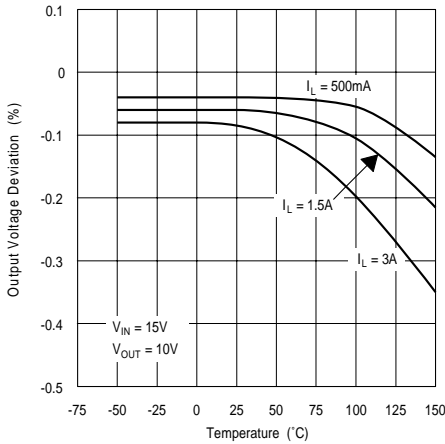

**Output Impedance**

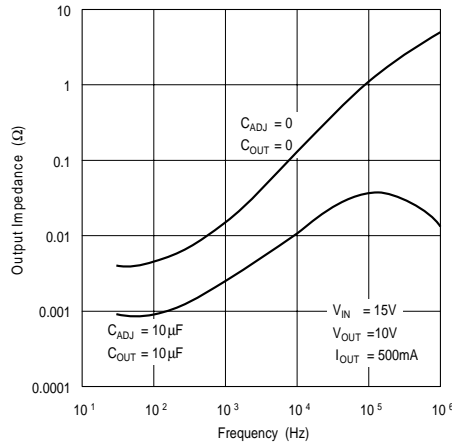

**Adjustment Current**

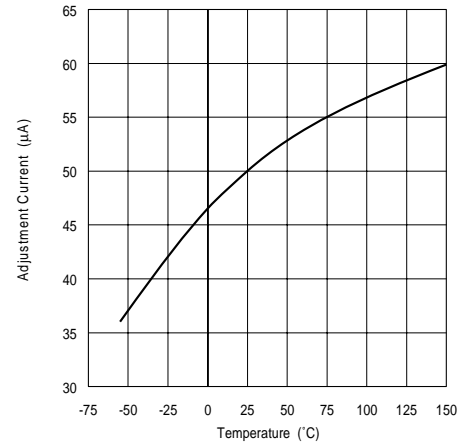

**Dropt Voltage**

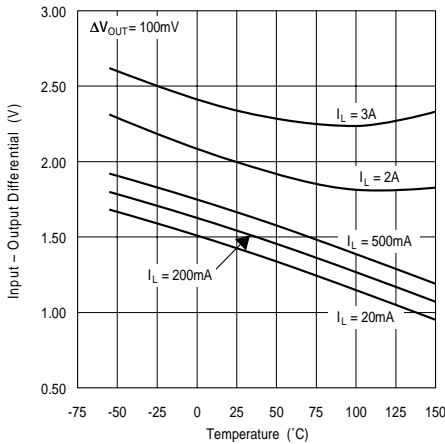

**Temperature Stability**

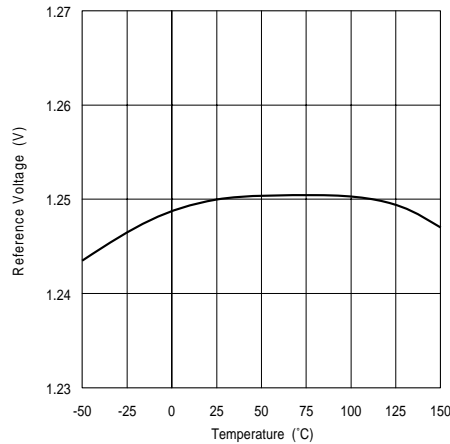

**Minimum Operating Current**

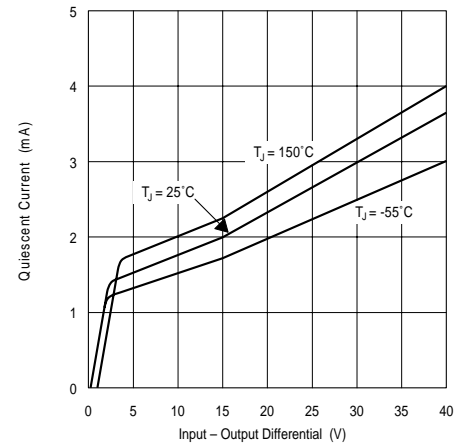

**Ripple Rejection**

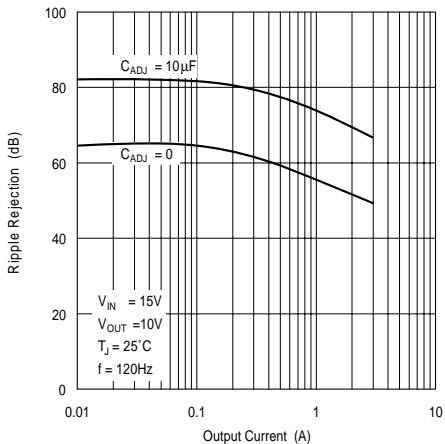

**Ripple Rejection**

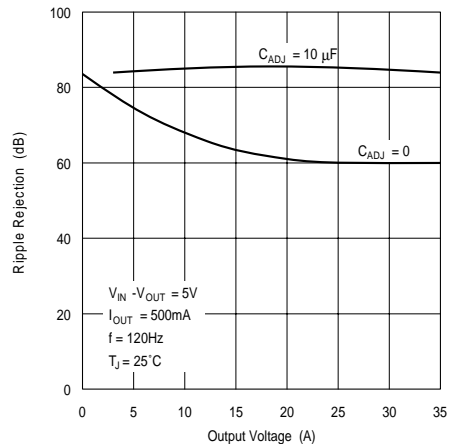

**Ripple Rejection**

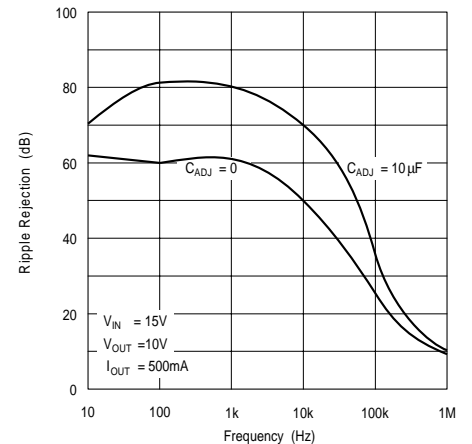

**TYPICAL PERFORMANCE CHARACTERISTICS**

**Current Limit**

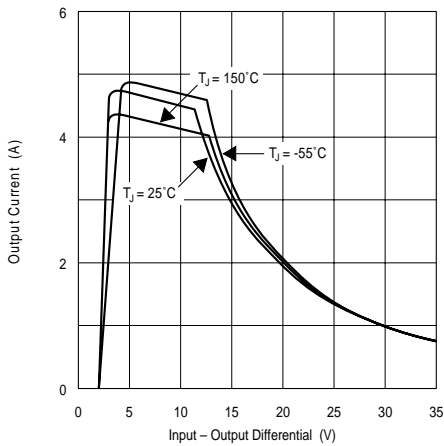

**Current Limit**

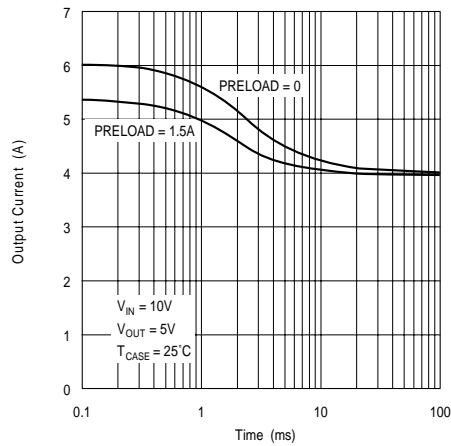

**Current Limit**

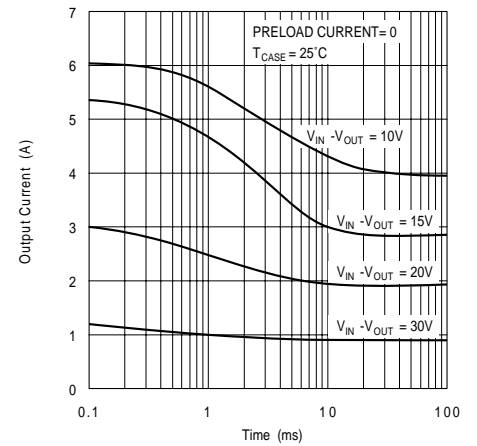

**Line Transient Response**

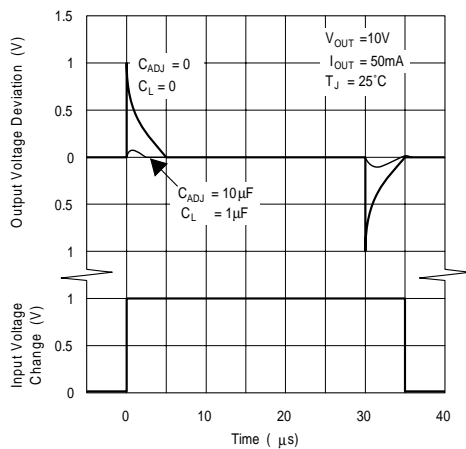

**Load Transient Response**

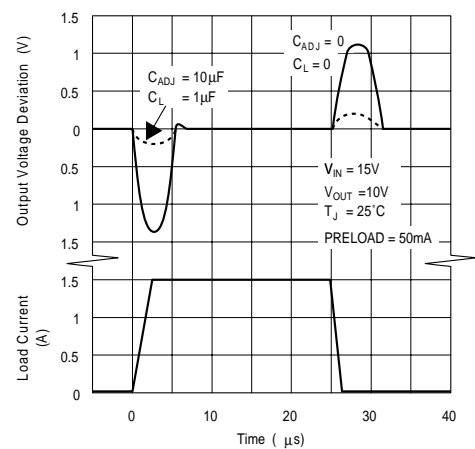

**APPLICATIONS INFORMATION**

**Remote Sensing**

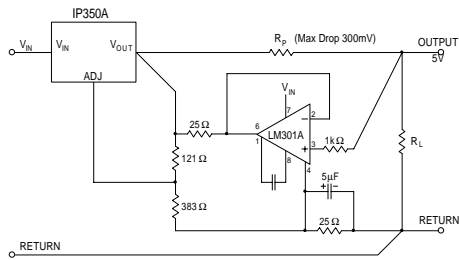

**5V Regulator with Shut Down**

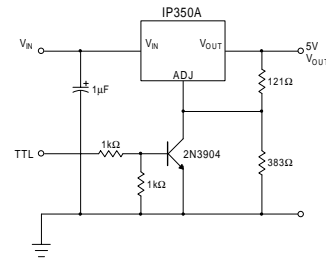

**2816 EEPROM Supply Programmer for Read/Write Control**

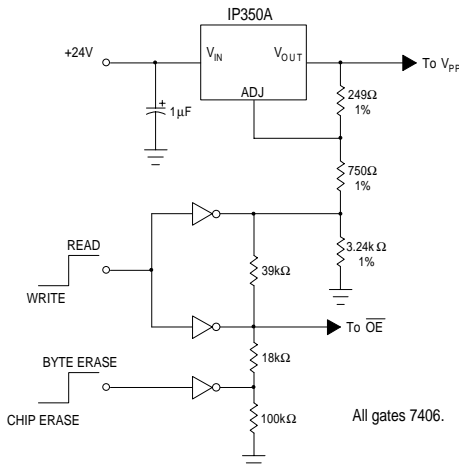

	$\overline{OE}$	$V_{PP}$
READ	0V	5V
WRITE		
BYTE ERASE	5V	21V
CHIP ERASE	12V	21V

**Improving Ripple Rejection**

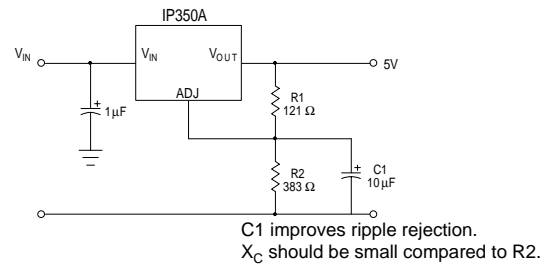

**Temperature Compensated Lead-Acid Battery Charger**

