

# Switching diode

## DA221 / DA204U / DA204K DA228U / DA228K / UMR12N

### ●Applications

Bias circuits  
Protection circuits

### ●Features

- 1) Three types of packages are available.  
(EMD3,UMD3,SMD3)
- 2) Two diode elements are connected in series  
( $V_F \times 2$ ) per circuit.

### ●Construction

Silicon epitaxial planar

### ●Circuit

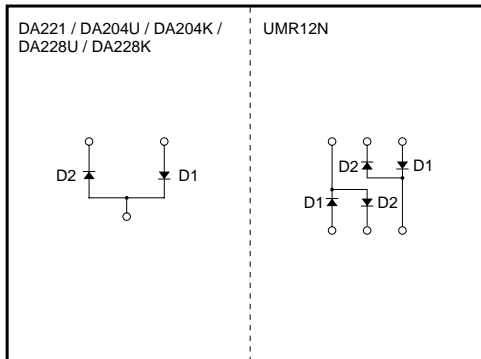

### ●External dimensions (Units : mm)

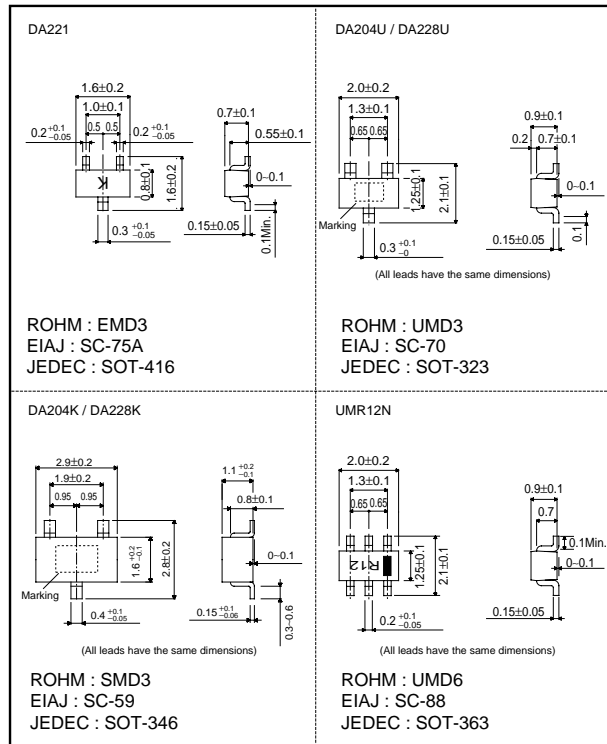

### ●Marking

EMD3		UMD3		UMD6		SMD3	
DA221		DA204U		UMR12N		DA204K	
-	-	DA228U		-	-	DA228K	

# DA221 / DA204U / DA204K / DA228U / DA228K / UMR12N

## Diodes

### ●Absolute maximum ratings (Ta=25°C)

Type	Peak reverse voltage V <sub>RM</sub> (V)	DC reverse voltage V <sub>R</sub> (V)	Peak forward current I <sub>FM</sub> (mA)	Mean rectifying current I <sub>o</sub> (mA)	Surge current (1μs) I <sub>surge</sub> (mA)	Power dissipation (TOTAL) Pd(mW)	Junction temperature T <sub>J</sub> (°C)	Storage temperature T <sub>stg</sub> (°C)
DA221	20	20	200	100	300	150	150	-55~+150
DA204U	20	20	200	100	300	200	150	-55~+150
DA228U	80	80	200	100	300	200	150	-55~+150
DA204K	20	20	200	100	300	200	150	-55~+150
DA228K	80	80	200	100	300	200	150	-55~+150
UMR12N	80	80	200	100	300	200	150	-55~+150

### ●Electrical characteristics (Ta=25°C)

Type	Forward voltage		Reverse current		Fig.
	V <sub>F</sub> (V) Max.	Cond. I <sub>F</sub> (mA)	I <sub>R</sub> (μA) Max.	Cond. V <sub>R</sub> (V)	
DA221	1.0	10	0.1	15	1~4
DA204U	1.0	10	0.1	15	1~4
DA228U	1.2	100	0.1	80	5~9
DA204K	1.0	10	0.1	15	1~4
DA228K	1.2	100	0.1	80	5~9
UMR12N	1.2	100	0.1	80	5~9

### ●Electrical characteristic curves (Ta=25°C)

(DA221, DA204U, DA204K) ...Fig.1~4

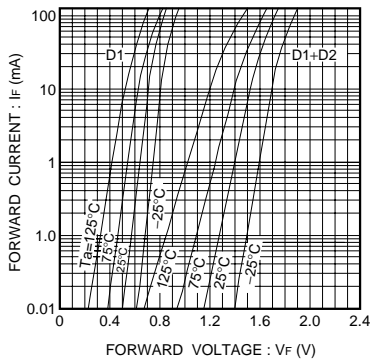

Fig.1 Forward characteristics

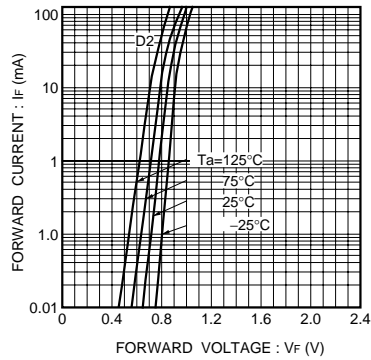

Fig.2 Forward characteristics

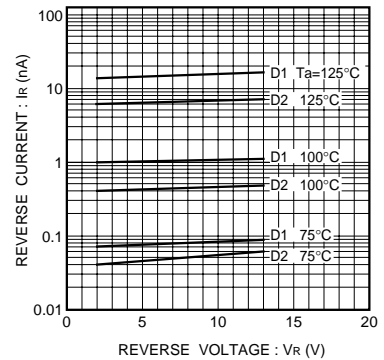

Fig.3 Reverse characteristics

Diodes

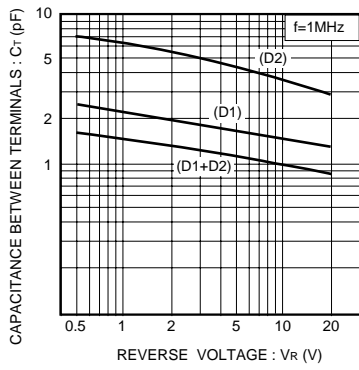

Fig.4 Capacitance between terminals characteristics

(DA228U, DA228K, UMR12N) ...Fig.5~9

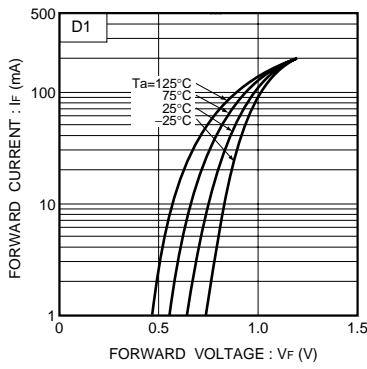

Fig.5 Forward characteristics

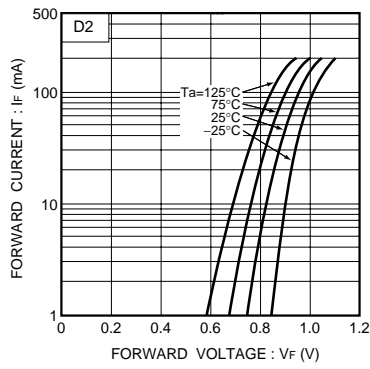

Fig.6 Forward characteristics

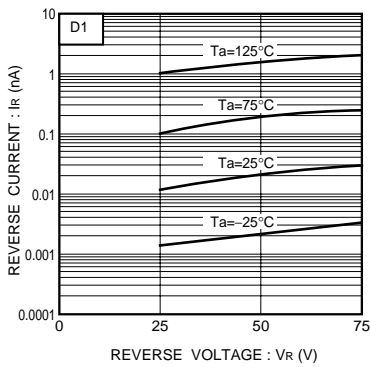

Fig.7 Reverse characteristics

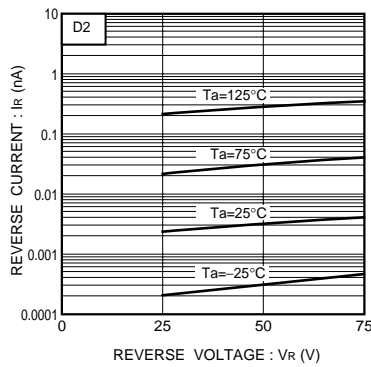

Fig.8 Reverse characteristics

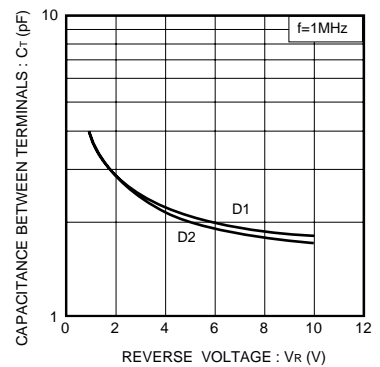

Fig.9 Capacitance between terminals characteristics