

## FFH30US30DN

### 30A, 300V Stealth™ Diode

#### General Description

The FFH30US30DN is a Stealth™ diode optimized for low loss performance in output rectification. The Stealth™ family exhibits low reverse recovery current ( $I_{RM(REC)}$ ), low  $V_F$  and soft recovery under typical operating conditions.

This device is intended for use as an output rectification diode in Telecom power supplies and other power switching applications. Lower  $V_F$  and  $I_{RM(REC)}$  reduces diode losses.

Formerly developmental type TA49449.

#### Features

- Soft Recovery . . . . .  $t_b/t_a > 0.45$
- Fast Recovery . . . . .  $t_{rr} < 50ns$
- High Operating Temperature . . . . . 175°C
- Reverse Voltage . . . . . 300V
- Avalanche Energy Rating . . . . . .20mJ

#### Applications

- Switch Mode Power Supplies
- Power Factor Correction
- Uninterruptable Power Supplies
- Motor Drives
- Welders

#### Package

JEDEC STYLE 3 LEAD TO-247

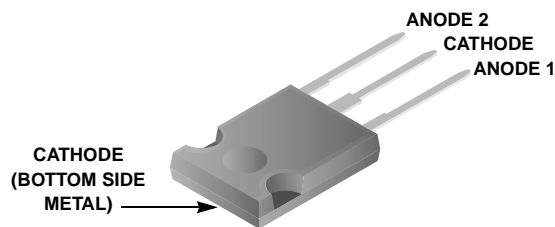

#### Symbol

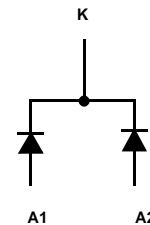

#### Device Maximum Ratings (per leg) $T_C = 25^\circ\text{C}$ unless otherwise noted

Symbol	Parameter	Ratings	Units
$V_{RRM}$	Repetitive Peak Reverse Voltage	300	V
$V_{RWM}$	Working Peak Reverse Voltage	300	V
$V_R$	DC Blocking Voltage	300	V
$I_{F(AV)}$	Average Rectified Forward Current ( $T_C = 160^\circ\text{C}$ )	30	A
	Total Device Current (Both Legs)	60	A
$I_{FRM}$	Repetitive Peak Surge Current (20kHz Square Wave)	70	A
$I_{FSM}$	Nonrepetitive Peak Surge Current (Halfwave 1 Phase 60Hz)	325	A
$P_D$	Power Dissipation	230	W
$E_{AVL}$	Avalanche Energy (1A, 40mH)	20	mJ
$T_J, T_{STG}$	Operating and Storage Temperature Range	-55 to 175	°C
$T_L$ $T_{PKG}$	Maximum Temperature for Soldering		
	Leads at 0.063in (1.6mm) from Case for 10s Package Body for 10s, See Application Note AN-7528	300 260	°C °C

CAUTION: Stresses above those listed in "Device Maximum Ratings" may cause permanent damage to the device. This is a stress only rating and operation of the device at these or any other conditions above those indicated in the operational sections of this specification is not implied.

## Package Marking and Ordering Information

Device Marking	Device	Package	Tape Width	Quantity
30US30DN	FFH30US30DN	TO-247	N/A	30

## Electrical Characteristics (per leg) $T_C = 25^\circ\text{C}$ unless otherwise noted

Symbol	Parameter	Test Conditions	Min	Typ	Max	Units
--------	-----------	-----------------	-----	-----	-----	-------

### Off State Characteristics

$I_R$	Instantaneous Reverse Current	$V_R = 300\text{V}$	$T_C = 25^\circ\text{C}$	-	-	100	$\mu\text{A}$
			$T_C = 125^\circ\text{C}$	-	-	1	$\text{mA}$

### On State Characteristics

$V_F$	Instantaneous Forward Voltage	$I_F = 30\text{A}$	$T_C = 25^\circ\text{C}$	-	0.93	1.0	V
			$T_C = 125^\circ\text{C}$	-	0.8	0.87	V

### Dynamic Characteristics

$C_J$	Junction Capacitance	$V_R = 10\text{V}, I_F = 0\text{A}$	-	410	-	$\text{pF}$
-------	----------------------	-------------------------------------	---	-----	---	-------------

### Switching Characteristics

$t_{rr}$	Reverse Recovery Time	$I_F = 1\text{A}, di_F/dt = 100\text{A}/\mu\text{s}, V_R = 15\text{V}$	-	29	50	$\text{ns}$
			$I_F = 30\text{A}, di_F/dt = 100\text{A}/\mu\text{s}, V_R = 15\text{V}$	-	32	55
$t_{rr}$	Reverse Recovery Time	$I_F = 30\text{A}, di_F/dt = 200\text{A}/\mu\text{s}, V_R = 195\text{V}, T_C = 25^\circ\text{C}$	-	46	-	$\text{ns}$
$I_{RM(REC)}$	Maximum Reverse Recovery Current		-	5.3	-	A
$Q_{RR}$	Reverse Recovered Charge		-	140	-	$\text{nC}$
$t_{rr}$	Reverse Recovery Time		-	77	-	$\text{ns}$
S	Softness Factor ( $t_b/t_a$ )	$V_R = 195\text{V}, T_C = 125^\circ\text{C}$	-	0.45	-	-
$I_{RM(REC)}$	Maximum Reverse Recovery Current		-	9	-	A
$Q_{RR}$	Reverse Recovered Charge		-	400	-	$\text{nC}$
$t_{rr}$	Reverse Recovery Time		-	54	-	$\text{ns}$
S	Softness Factor ( $t_b/t_a$ )	$I_F = 30\text{A}, di_F/dt = 1000\text{A}/\mu\text{s}, V_R = 195\text{V}, T_C = 125^\circ\text{C}$	-	0.49	-	-
$I_{RM(REC)}$	Maximum Reverse Recovery Current		-	32	-	A
$Q_{RR}$	Reverse Recovered Charge		-	930	-	$\text{nC}$

### Thermal Characteristics

$R_{\theta JC}$	Thermal Resistance Junction to Case	TO-247	-	-	0.65	$^\circ\text{C}/\text{W}$
$R_{\theta JA}$	Thermal Resistance Junction to Ambient	TO-247	-	-	30	$^\circ\text{C}/\text{W}$

**Typical Performance Curves (per leg)**

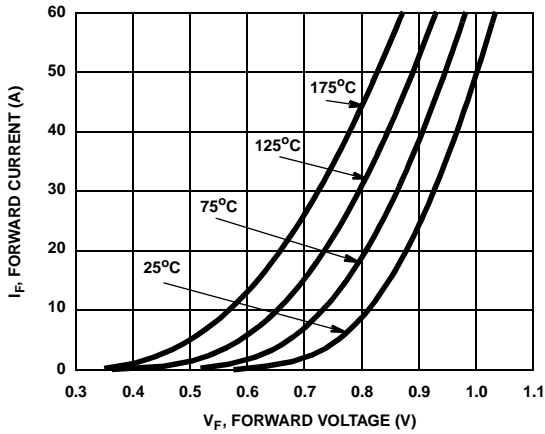

**Figure 1. Forward Current vs Forward Voltage**

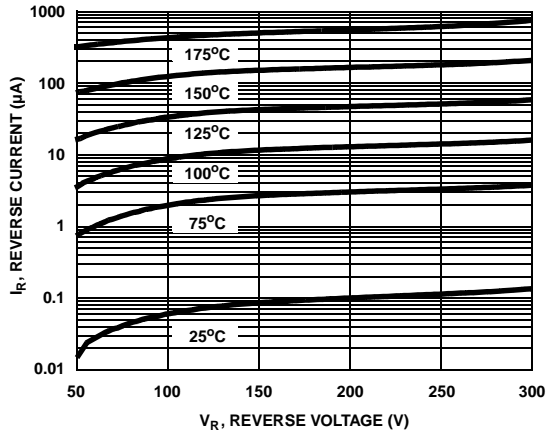

**Figure 2. Reverse Current vs Reverse Voltage**

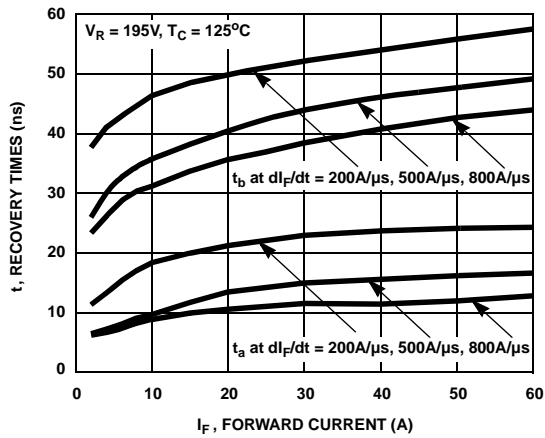

**Figure 3.  $t_a$  and  $t_b$  Curves vs Forward Current**

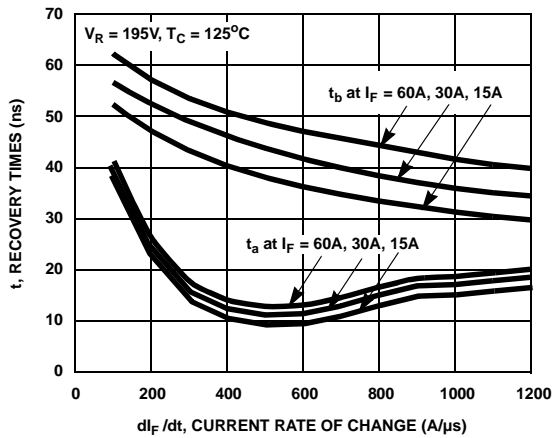

**Figure 4.  $t_a$  and  $t_b$  Curves vs  $di_F/dt$**

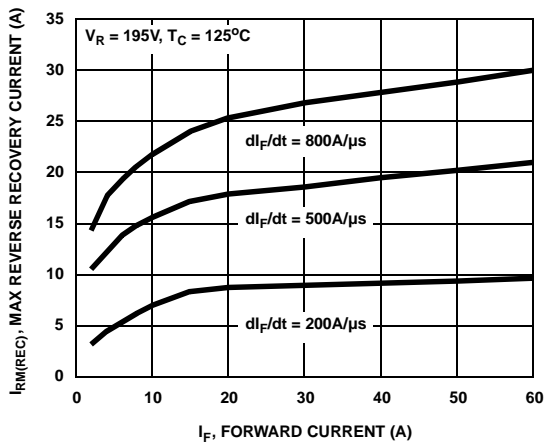

**Figure 5. Maximum Reverse Recovery Current vs Forward Current**

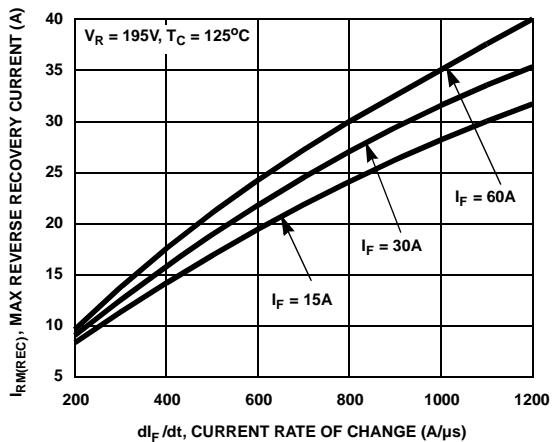

**Figure 6. Maximum Reverse Recovery Current vs  $di_F/dt$**

Typical Performance Curves (per leg) (Continued)

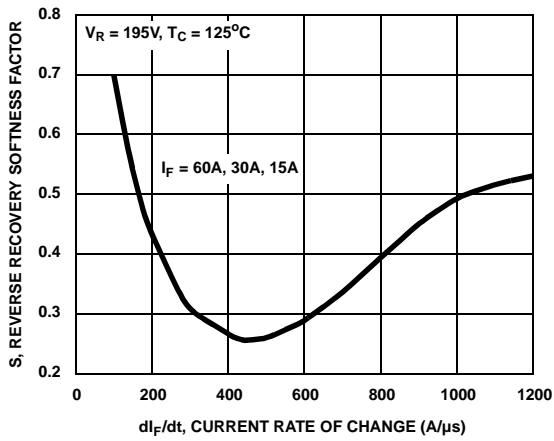

Figure 7. Reverse Recovery Softness Factor vs  $dI_F/dt$

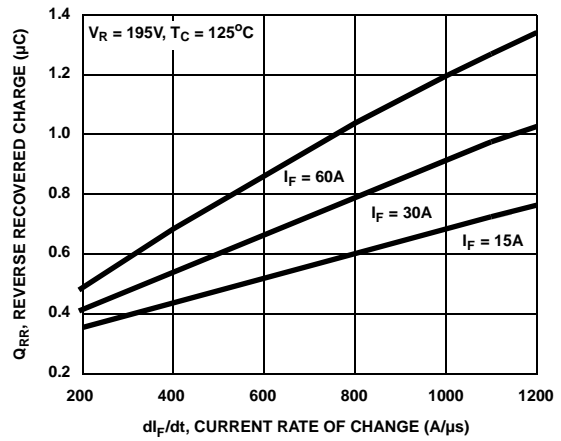

Figure 8. Reverse Recovery Charge vs  $dI_F/dt$

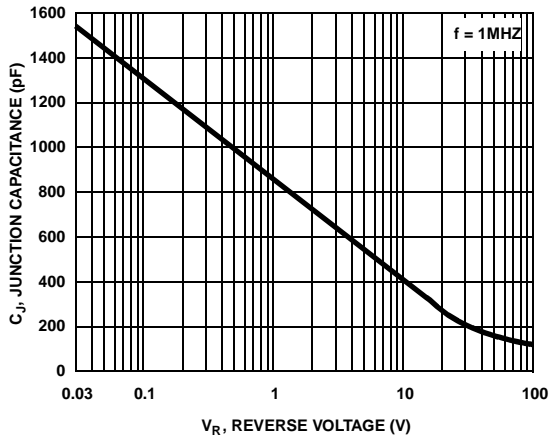

Figure 9. Junction Capacitance vs Reverse Voltage

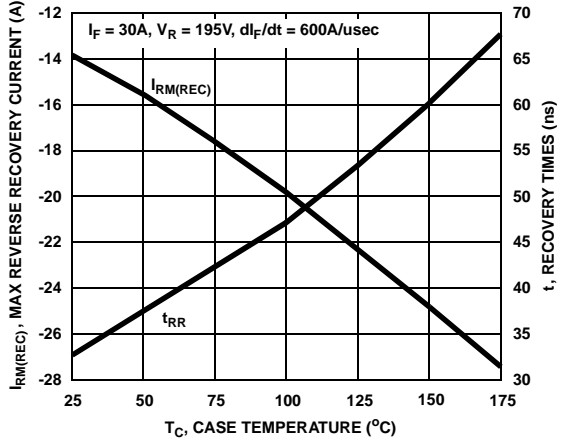

Figure 10. Maximum Reverse Recovery Current and  $t_{rr}$  vs Case Temperature

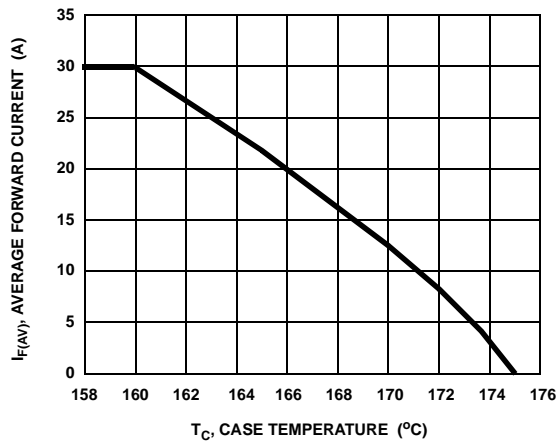

Figure 11. DC CURRENT DERATING CURVE

Typical Performance Curves (per leg) (Continued)

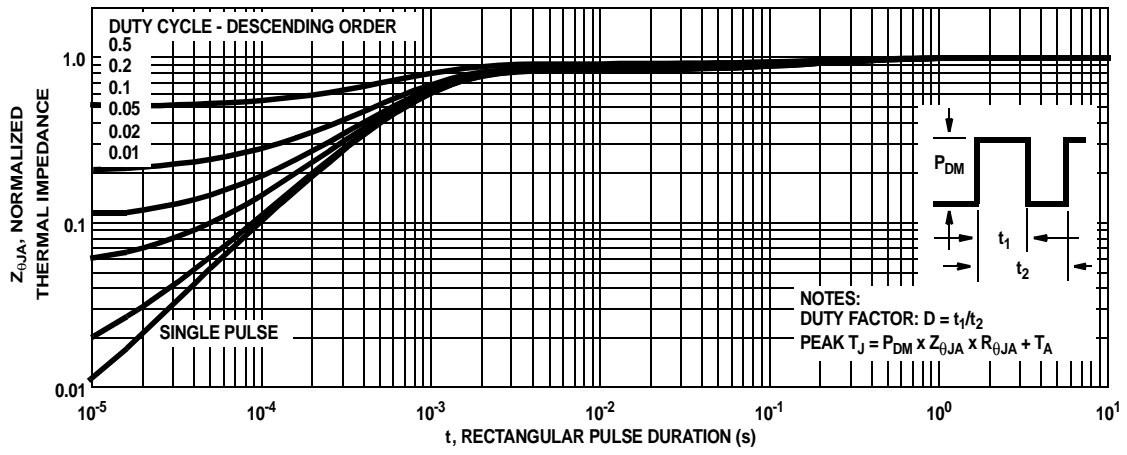

Figure 12. Normalized Maximum Transient Thermal Impedance

Test Circuit and Waveforms

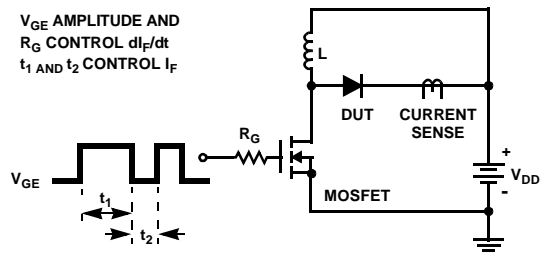

Figure 13.  $t_{tr}$  Test Circuit

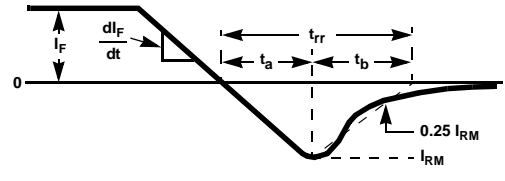
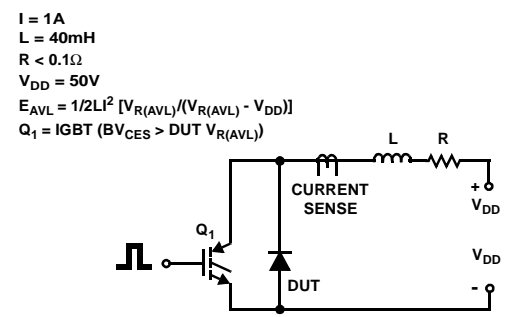

Figure 14.  $t_{tr}$  Waveforms and Definitions



$I = 1A$   
 $L = 40mH$   
 $R < 0.1\Omega$   
 $V_{DD} = 50V$   
 $E_{AVL} = 1/2LI^2 [V_{R(AVL)}/(V_{R(AVL)} - V_{DD})]$   
 $Q_1 = IGBT (BV_{CES} > DUT V_{R(AVL)})$

Figure 15. Avalanche Energy Test Circuit

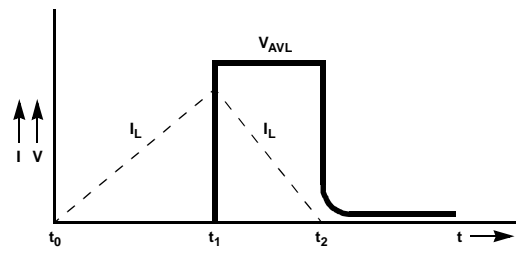

Figure 16. Avalanche Current and Voltage Waveforms

## TRADEMARKS

The following are registered and unregistered trademarks Fairchild Semiconductor owns or is authorized to use and is not intended to be an exhaustive list of all such trademarks.

ACEx™	FACT™	ImpliedDisconnect™	PACMAN™	SPM™
ActiveArray™	FACT Quiet Series™	ISOPLANAR™	POP™	Stealth™
Bottomless™	FAST®	LittleFET™	Power247™	SuperSOT™-3
CoolFET™	FASTr™	MicroFET™	PowerTrench®	SuperSOT™-6
CROSSVOLT™	FRFET™	MicroPak™	QFET™	SuperSOT™-8
DOME™	GlobalOptoisolator™	MICROWIRE™	QS™	SyncFET™
EcoSPARK™	GTO™	MSX™	QT Optoelectronics™	TinyLogic®
E <sup>2</sup> CMOS™	HiSeC™	MSXPro™	Quiet Series™	TruTranslation™
EnSigna™	I <sup>2</sup> C™	OCX™	RapidConfigure™	UHC™
Across the board. Around the world.™		OCXPro™	RapidConnect™	UltraFET®
The Power Franchise™		OPTOLOGIC®	SILENT SWITCHER®	VCX™
Programmable Active Droop™		OPTOPLANAR™	SMART START™	

## DISCLAIMER

FAIRCHILD SEMICONDUCTOR RESERVES THE RIGHT TO MAKE CHANGES WITHOUT FURTHER NOTICE TO ANY PRODUCTS HEREIN TO IMPROVE RELIABILITY, FUNCTION OR DESIGN. FAIRCHILD DOES NOT ASSUME ANY LIABILITY ARISING OUT OF THE APPLICATION OR USE OF ANY PRODUCT OR CIRCUIT DESCRIBED HEREIN; NEITHER DOES IT CONVEY ANY LICENSE UNDER ITS PATENT RIGHTS, NOR THE RIGHTS OF OTHERS.

## LIFE SUPPORT POLICY

FAIRCHILD'S PRODUCTS ARE NOT AUTHORIZED FOR USE AS CRITICAL COMPONENTS IN LIFE SUPPORT DEVICES OR SYSTEMS WITHOUT THE EXPRESS WRITTEN APPROVAL OF FAIRCHILD SEMICONDUCTOR CORPORATION.

As used herein:

1. Life support devices or systems are devices or systems which, (a) are intended for surgical implant into the body, or (b) support or sustain life, or (c) whose failure to perform when properly used in accordance with instructions for use provided in the labeling, can be reasonably expected to result in significant injury to the user.
2. A critical component is any component of a life support device or system whose failure to perform can be reasonably expected to cause the failure of the life support device or system, or to affect its safety or effectiveness.

## PRODUCT STATUS DEFINITIONS

### Definition of Terms

Datasheet Identification	Product Status	Definition
Advance Information	Formative or In Design	This datasheet contains the design specifications for product development. Specifications may change in any manner without notice.
Preliminary	First Production	This datasheet contains preliminary data, and supplementary data will be published at a later date. Fairchild Semiconductor reserves the right to make changes at any time without notice in order to improve design.
No Identification Needed	Full Production	This datasheet contains final specifications. Fairchild Semiconductor reserves the right to make changes at any time without notice in order to improve design.
Obsolete	Not In Production	This datasheet contains specifications on a product that has been discontinued by Fairchild semiconductor. The datasheet is printed for reference information only.