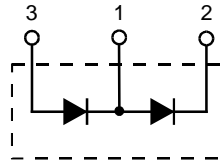
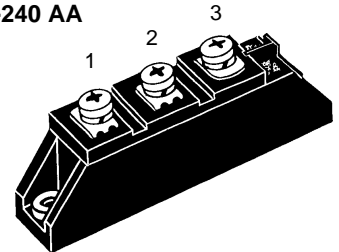

Diode Modules

$I_{FRMS} = 2 \times 180 \text{ A}$
 $I_{FAVM} = 2 \times 113 \text{ A}$
 $V_{RRM} = 800-1800 \text{ V}$

V_{RSM} V	V_{RRM} V	Type
900	800	MDD 72-08N1 B
1300	1200	MDD 72-12N1 B
1500	1400	MDD 72-14N1 B
1700	1600	MDD 72-16N1 B
1900	1800	MDD 72-18N1 B

TO-240 AA

Symbol	Test Conditions	Maximum Ratings	
I_{FRMS}	$T_{VJ} = T_{VJM}$	180	A
I_{FAVM}	$T_C = 92^\circ\text{C}; 180^\circ \text{ sine}$	113	A
	$T_C = 100^\circ\text{C}; 180^\circ \text{ sine}$	99	A
I_{FSM}	$T_{VJ} = 45^\circ\text{C}; V_R = 0$	t = 10 ms (50 Hz), sine	1700 A
		t = 8.3 ms (60 Hz), sine	1950 A
	$T_{VJ} = T_{VJM}; V_R = 0$	t = 10 ms (50 Hz), sine	1540 A
		t = 8.3 ms (60 Hz), sine	1800 A
$\int i^2 dt$	$T_{VJ} = 45^\circ\text{C}; V_R = 0$	t = 10 ms (50 Hz), sine	14 450 A ² s
		t = 8.3 ms (60 Hz), sine	15 700 A ² s
	$T_{VJ} = T_{VJM}; V_R = 0$	t = 10 ms (50 Hz), sine	11 850 A ² s
		t = 8.3 ms (60 Hz), sine	13 400 A ² s
T_{VJ}		-40...+150	°C
T_{VJM}		150	°C
T_{stg}		-40...+125	°C
V_{ISOL}	50/60 Hz, RMS	t = 1 min	3000 V~
	$I_{ISOL} \leq 1 \text{ mA}$	t = 1 s	3600 V~
M_d	Mounting torque (M5)		2.5-4/22-35 Nm/lb.in.
	Terminal connection torque (M5)		2.5-4/22-35 Nm/lb.in.
Weight	Typical including screws		90 g

Features

- International standard package JEDEC TO-240 AA
- Direct copper bonded Al₂O₃ -ceramic base plate
- Planar passivated chips
- Isolation voltage 3600 V~
- UL registered, E 72873

Applications

- Supplies for DC power equipment
- DC supply for PWM inverter
- Field supply for DC motors
- Battery DC power supplies

Advantages

- Space and weight savings
- Simple mounting
- Improved temperature and power cycling
- Reduced protection circuits

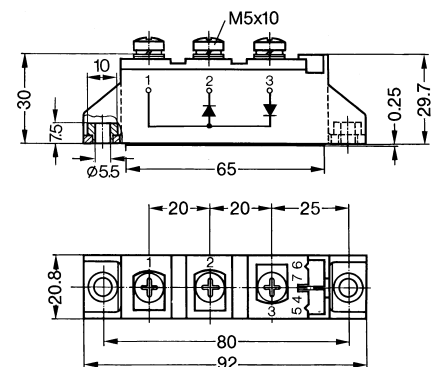
Dimensions in mm (1 mm = 0.0394")

Symbol	Test Conditions	Characteristic Values		
I_R	$T_{VJ} = T_{VJM}; V_R = V_{RRM}$	15	mA	
V_F	$I_F = 300 \text{ A}; T_{VJ} = 25^\circ\text{C}$	1.6	V	
V_{T0}	For power-loss calculations only	0.8	V	
r_T	$T_{VJ} = T_{VJM}$	2.3	mΩ	
Q_S	$T_{VJ} = 125^\circ\text{C}; I_F = 50 \text{ A}, -di/dt = 3 \text{ A}/\mu\text{s}$	170	μC	
I_{RM}		45	A	
R_{thJC}	per diode; DC current	} other values see Fig. 6/7	0.35	K/W
			per module	0.175
	per diode; DC current		0.55	K/W
			per module	0.275
d_s	Creepage distance on surface	12.7	mm	
d_A	Strike distance through air	9.6	mm	
a	Maximum allowable acceleration	50	m/s ²	

Data according to IEC 60747 and refer to a single diode unless otherwise stated. IXYS reserves the right to change limits, test conditions and dimensions

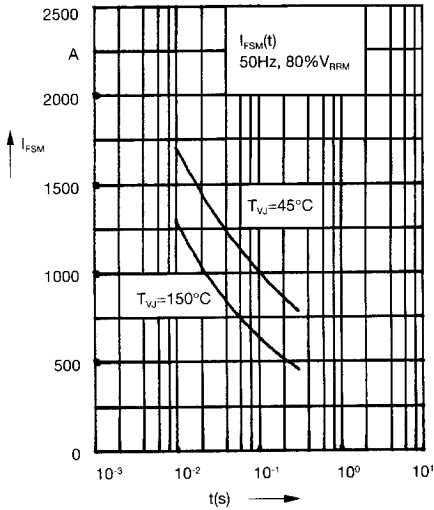

Fig. 1 Surge overload current
 I_{FSM} : Crest value, t: duration

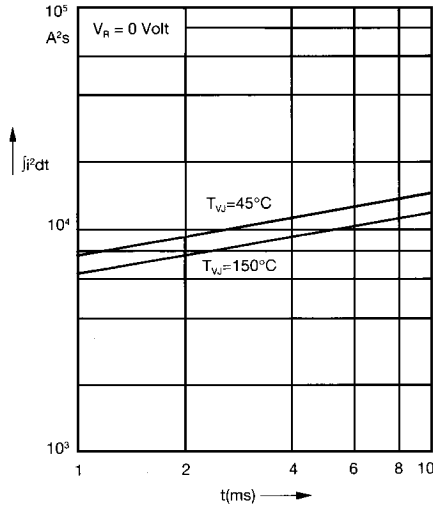

Fig. 2 $j_i^2 dt$ versus time (1-10 ms)

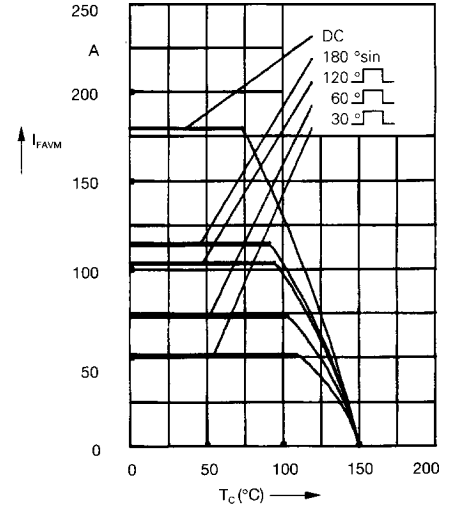

Fig. 2a Maximum forward current at case temperature

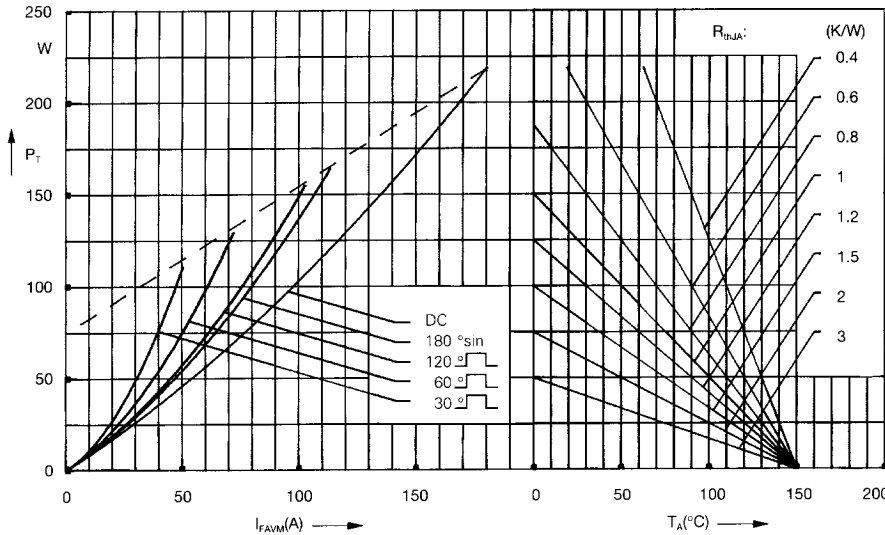

Fig. 3 Power dissipation versus forward current and ambient temperature (per diode)

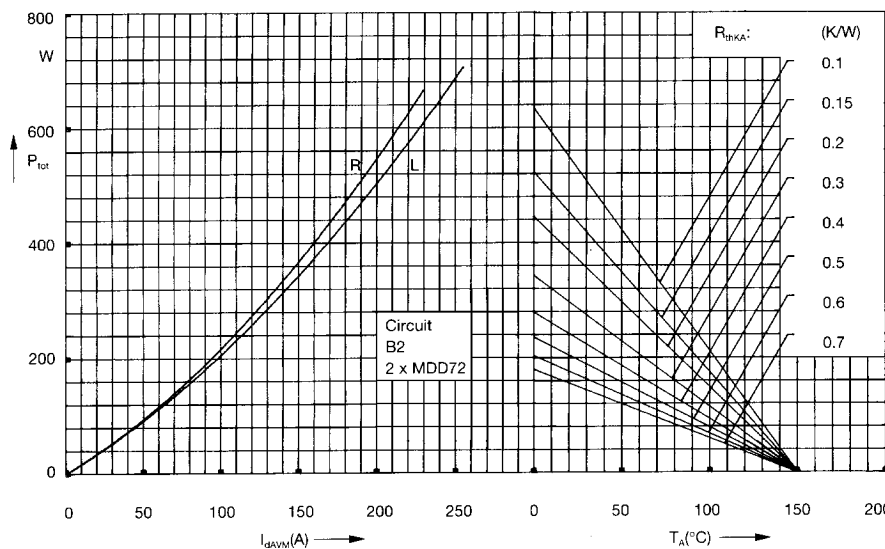

Fig. 4 Single phase rectifier bridge:
 Power dissipation versus direct output current and ambient temperature
 R = resistive load
 L = inductive load

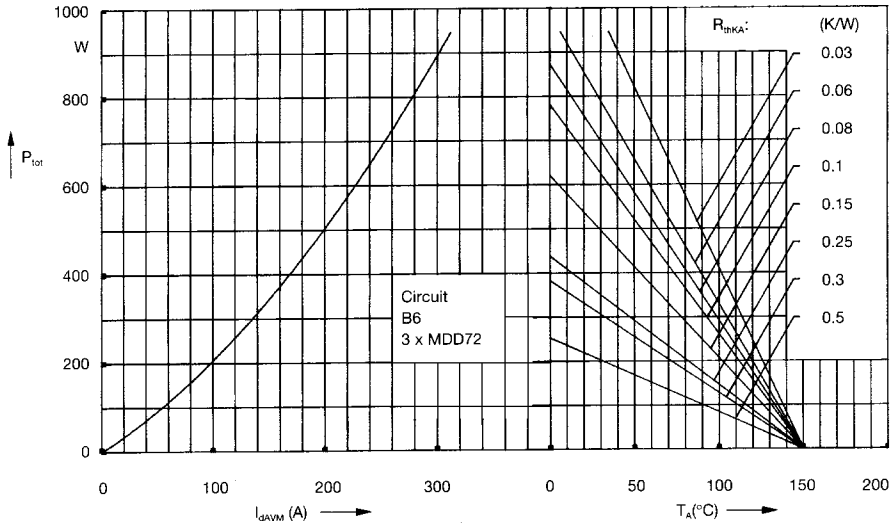

Fig. 5 Three phase rectifier bridge: Power dissipation versus direct output current and ambient temperature

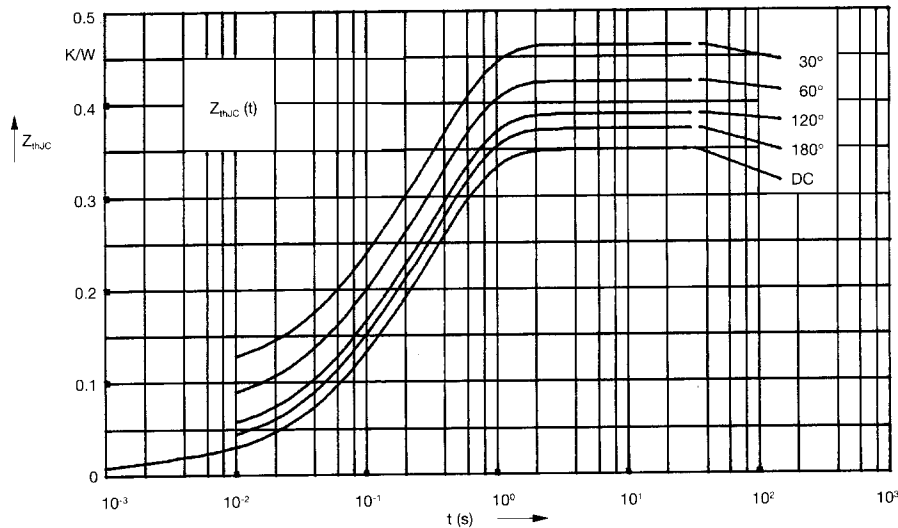

Fig. 6 Transient thermal impedance junction to case (per diode)

R_{thJC} for various conduction angles d:

d	R_{thJC} (K/W)
DC	0.35
180°	0.37
120°	0.39
60°	0.43
30°	0.47

Constants for Z_{thJC} calculation:

i	R_{thi} (K/W)	t_i (s)
1	0.013	0.0014
2	0.072	0.062
3	0.265	0.375

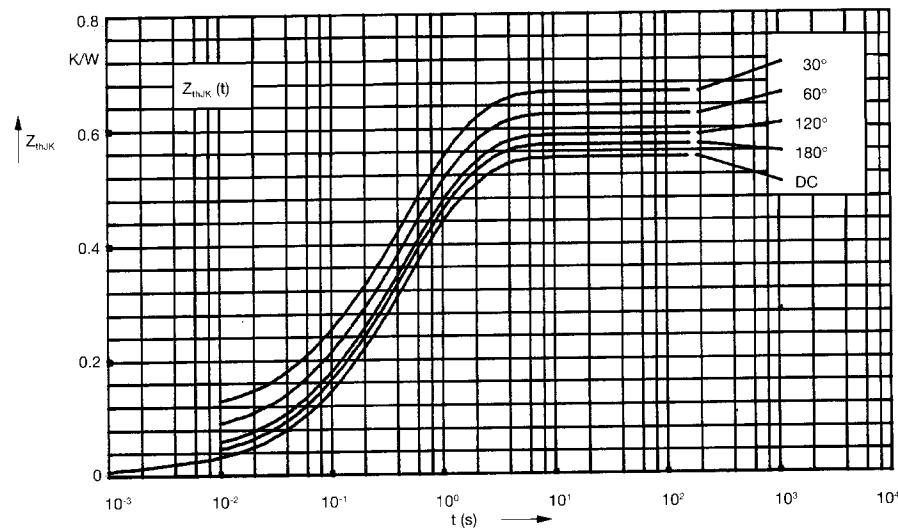

Fig. 7 Transient thermal impedance junction to heatsink (per diode)

R_{thJK} for various conduction angles d:

d	R_{thJK} (K/W)
DC	0.55
180°	0.57
120°	0.59
60°	0.63
30°	0.67

Constants for Z_{thJK} calculation:

i	R_{thi} (K/W)	t_i (s)
1	0.013	0.0014
2	0.072	0.062
3	0.265	0.375
4	0.2	1.32