

FAST RECOVERY DIODES

Hockey Puk Version

Features

- High power FAST recovery diode series
- 2.0 to 3.0 μ s recovery time
- High voltage ratings up to 2500V
- High current capability
- Optimized turn on and turn off characteristics
- Low forward recovery
- Fast and soft reverse recovery
- Press-puk encapsulation
- Case style conform to JEDEC DO-200AB (B-PUK)
- Maximum junction temperature 150°C

Typical Applications

- Snubber diode for GTO
- High voltage free-wheeling diode
- Fast recovery rectifier applications

700A
790A

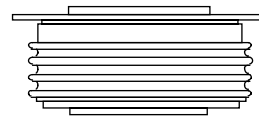

case style DO-200AB (B-PUK)

Major Ratings and Characteristics

Parameters	SD703C..L		Units
	S20	S30	
$I_{F(AV)}$	700	790	A
$@ T_{hs}$	55	55	°C
$I_{F(RMS)}$	1320	1470	A
I_{FSM}			
$@ 50\text{Hz}$	9300	9600	A
$@ 60\text{Hz}$	9730	10050	A
V_{RRM} range	1200 to 2500	1200 to 2500	V
t_{tr}	2.0	3.0	μ s
$@ T_J$	25	25	°C
T_J	- 40 to 150		°C

SD703C..L Series

Bulletin I2075 rev.D 04/00

International
IR Rectifier

ELECTRICAL SPECIFICATIONS

Voltage Ratings

Type number	Voltage Code	V_{RRM} , maximum repetitive peak reverse voltage V	V_{RSM} , maximum non-repetitive peak rev. voltage V	I_{RRM} max. @ $T_J = T_J$ max. mA
SD703C..L	12	1200	1300	50
	16	1600	1700	
	20	2000	2100	
	25	2500	2600	

Forward Conduction

Parameter	SD703C..L		Units	Conditions
	S20	S30		
$I_{F(AV)}$ Max. average forward current @ case temperature	700 (365) 55 (85)	790 (400) 55 (85)	A °C	180° conduction, half sine wave Double side (single side) cooled
$I_{F(RMS)}$ Max. RMS forward current	1320	1470	A	@ 25°C heatsink temperature double side cooled
I_{FSM} Max. peak, one-cycle forward, non-repetitive surge current	9300	9600	A	t = 10ms No voltage reappplied
	9730	10050		t = 8.3ms reappplied
	7820	8070		t = 10ms 100% V_{RRM}
	8190	8450		t = 8.3ms reappplied
I^2t Maximum I^2t for fusing	432	460	KA ² s	t = 10ms No voltage reappplied
	395	420		t = 8.3ms reappplied
	306	326		t = 10ms 100% V_{RRM}
	279	297		t = 8.3ms reappplied
$I^2\sqrt{t}$ Maximum $I^2\sqrt{t}$ for fusing	4320	4600	KA ² √s	t = 0.1 to 10ms, no voltage reappplied
$V_{F(TO)1}$ Low level value of threshold voltage	1.00	0.95	V	(16.7% x π x $I_{F(AV)}$) < I < (π x $I_{F(AV)}$), $T_J = T_J$ max.
$V_{F(TO)2}$ High level value of threshold voltage	1.11	1.05		(I > π x $I_{F(AV)}$), $T_J = T_J$ max.
r_{f1} Low level value of forward slope resistance	0.80	0.60	mΩ	(16.7% x π x $I_{F(AV)}$) < I < (π x $I_{F(AV)}$), $T_J = T_J$ max.
r_{f2} High level value of forward slope resistance	0.76	0.56		(I > π x $I_{F(AV)}$), $T_J = T_J$ max.
V_{FM} Max. forward voltage drop	2.20	1.85	V	$I_{pk} = 1500A$, $T_J = T_J$ max, $t_p = 10ms$ sinusoidal wave

Recovery Characteristics

Code	$T_J = 25^\circ C$ typical t_{rr} @ 25% I_{RRM} (μs)	Test conditions			Max. values @ $T_J = 150^\circ C$			
		I_{pk} Square Pulse (A)	di/dt (A/μs)	V_r (V)	t_{rr} @ 25% I_{RRM} (μs)	Q_{rr} (μC)	I_{rr} (A)	
S20	2.0	1000	50	-50	3.5	240	110	
S30	3.0	1000	50	-50	5.0	380	130	

Thermal and Mechanical Specifications

Parameter	SD703C..L		Units	Conditions
	S20	S30		
T _J Max. junction operating temperature range	-40 to 150		°C	
T _{stg} Max. storage temperature range	-40 to 150			
R _{thJ-hs} Max. thermal resistance, case junction to heatsink	0.092 0.046		K/W	DCoperation single side cooled DCoperation double side cooled
F Mounting force, ± 10%	9800 (1000)		N (Kg)	
wt Approximate weight	250		g	
Case style	DO-200AB (B-PUK)			See Outline Table

ΔR_{thJ-hs} Conduction

(The following table shows the increment of thermal resistance R_{thJ-hs} when devices operate at different conduction angles than DC)

Conduction angle	Sinusoidal conduction		Rectangular conduction		Units	Conditions
	Single Side	Double Side	Single Side	Double Side		
180°	0.011	0.011	0.008	0.008	K/W	T _J = T _J max.
120°	0.013	0.014	0.013	0.013		
90°	0.017	0.017	0.018	0.018		
60°	0.024	0.025	0.026	0.026		
30°	0.043	0.043	0.043	0.044		

Ordering Information Table

Device Code															
<table border="1" style="margin: auto;"> <tr> <td style="padding: 5px;">SD</td> <td style="padding: 5px;">70</td> <td style="padding: 5px;">3</td> <td style="padding: 5px;">C</td> <td style="padding: 5px;">25</td> <td style="padding: 5px;">S20</td> <td style="padding: 5px;">L</td> </tr> <tr> <td style="text-align: center;">①</td> <td style="text-align: center;">②</td> <td style="text-align: center;">③</td> <td style="text-align: center;">④</td> <td style="text-align: center;">⑤</td> <td style="text-align: center;">⑥</td> <td style="text-align: center;">⑦</td> </tr> </table>	SD	70	3	C	25	S20	L	①	②	③	④	⑤	⑥	⑦	<ul style="list-style-type: none"> 1 - Diode 2 - Essential part number 3 - 3 = Fast recovery 4 - C = Ceramic Puk 5 - Voltage code: Code x 100 = V_{RRM} (See Voltage Ratings table) 6 - t_{rr} code 7 - L = Puk Case DO-200AB (B-PUK)
SD	70	3	C	25	S20	L									
①	②	③	④	⑤	⑥	⑦									

SD703C..L Series

Bulletin I2075 rev.D 04/00

International
IRF Rectifier

Outline Table

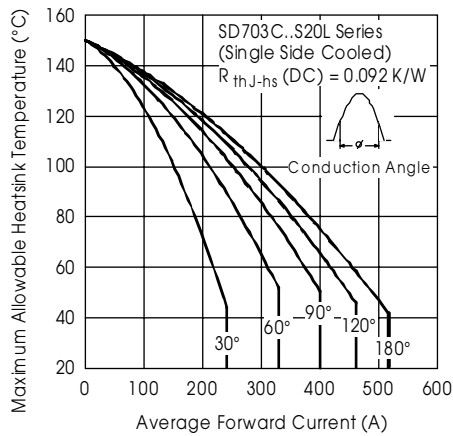
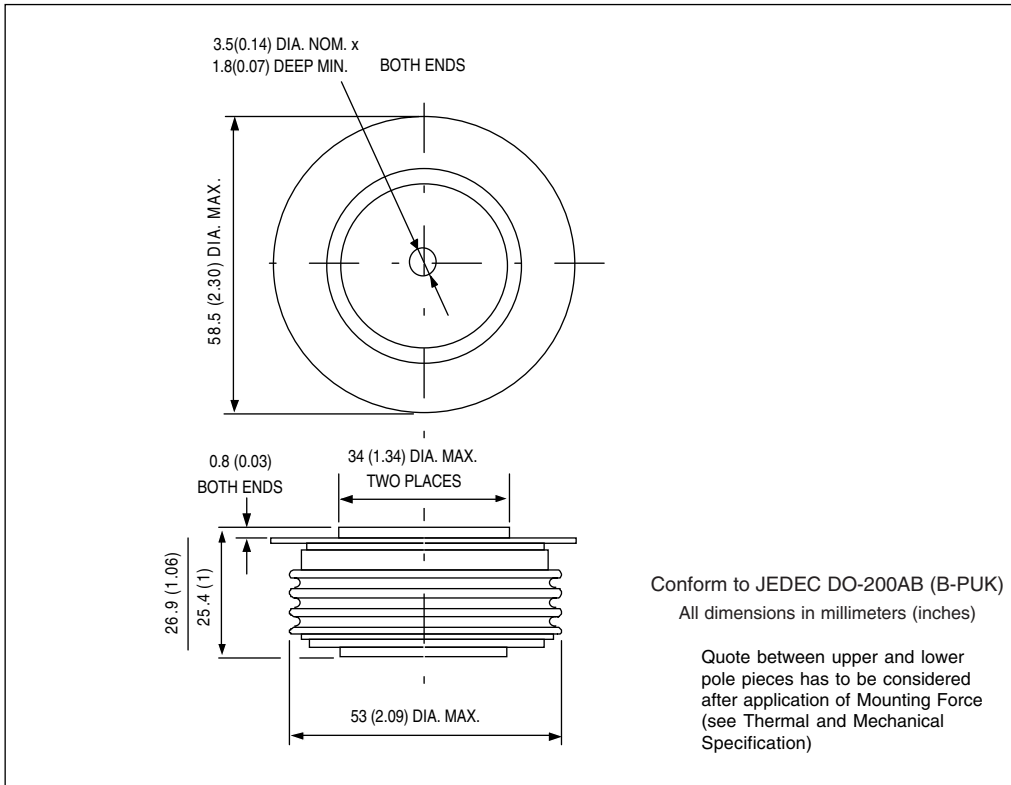

Fig. 1 - Current Ratings Characteristics

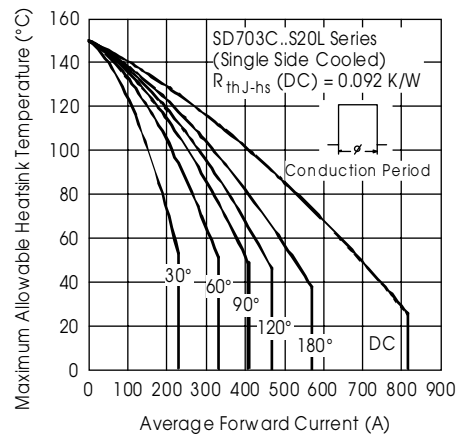

Fig. 2 - Current Ratings Characteristics

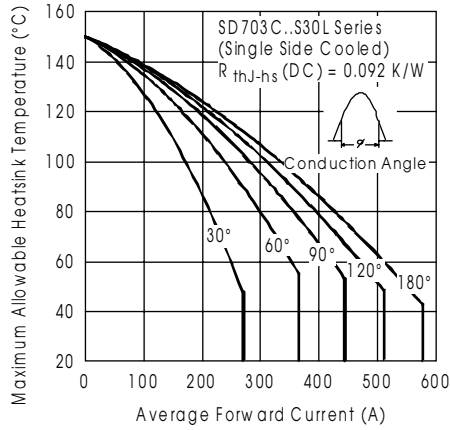

Fig. 3 - Current Ratings Characteristics

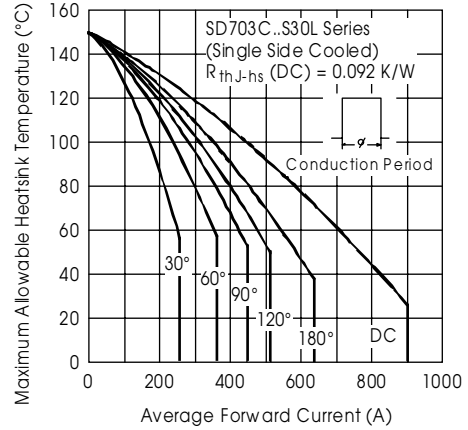

Fig. 4 - Current Ratings Characteristics

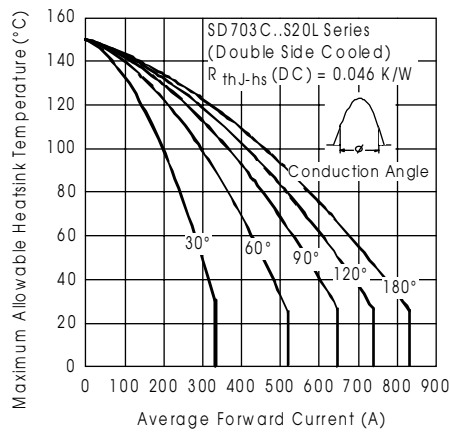

Fig. 5 - Current Ratings Characteristics

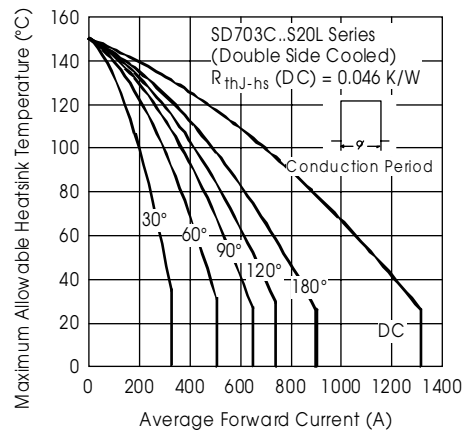

Fig. 6 - Current Ratings Characteristics

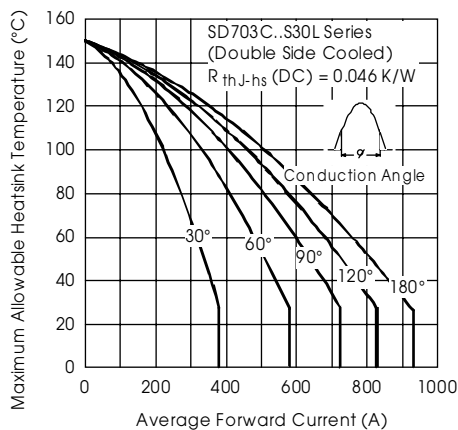

Fig. 7 - Current Ratings Characteristics

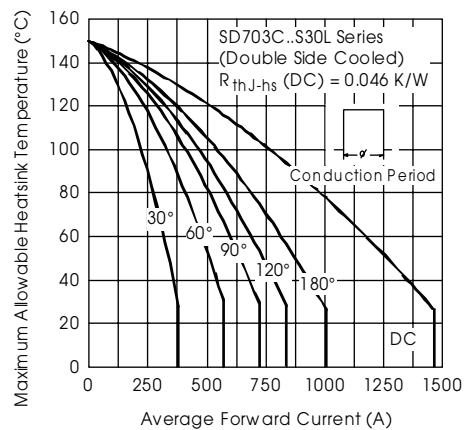

Fig. 8 - Current Ratings Characteristics

SD703C..L Series

Bulletin I2075 rev. D 04/00

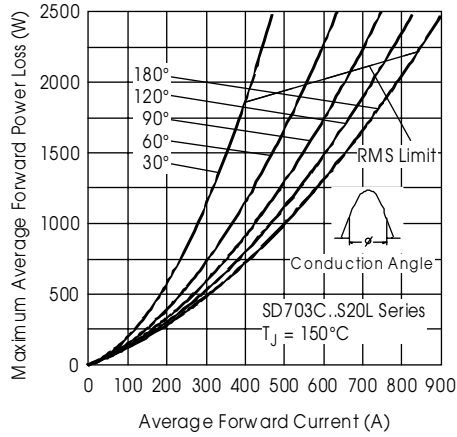

Fig. 9 - Forward Power Loss Characteristics

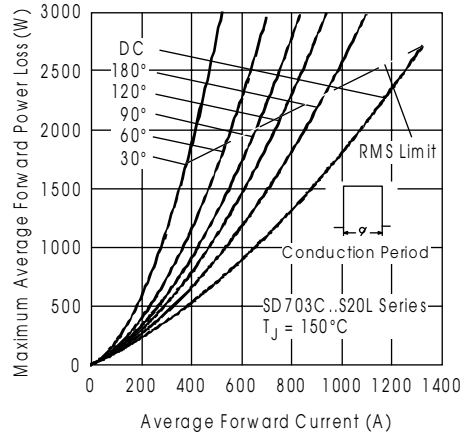

Fig. 10 - Forward Power Loss Characteristics

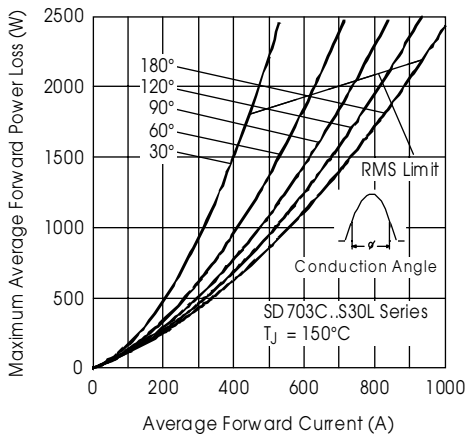

Fig. 11 - Forward Power Loss Characteristics

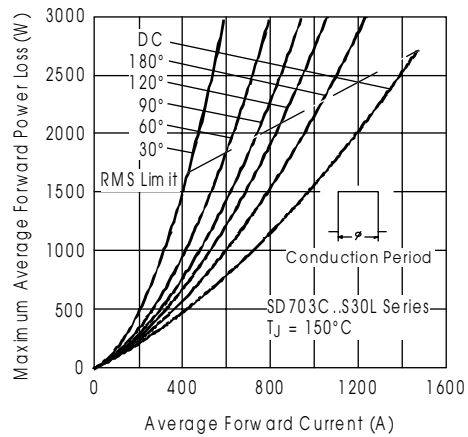

Fig. 12 - Forward Power Loss Characteristics

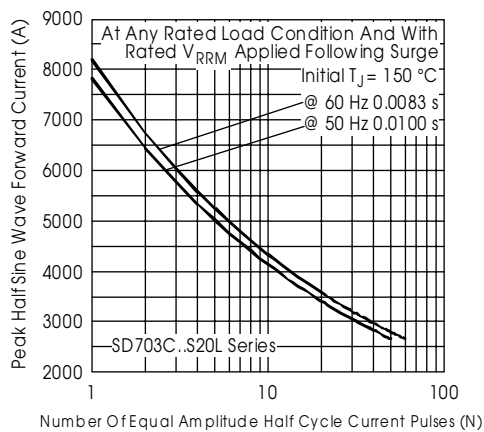

Fig. 13 - Maximum Non-repetitive Surge Current Single and Double Side Cooled

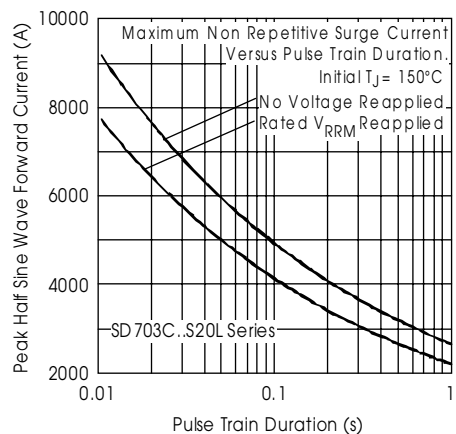

Fig. 14 - Maximum Non-repetitive Surge Current Single and Double Side Cooled

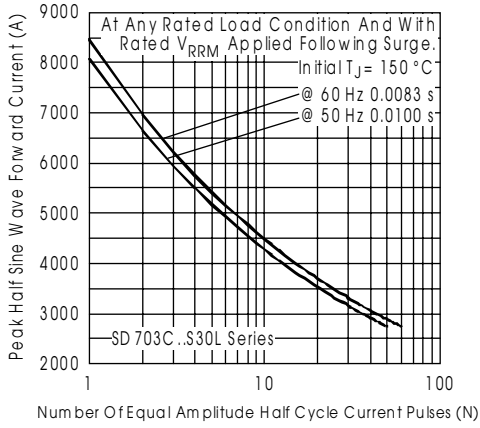

Fig. 15 - Maximum Non-repetitive Surge Current Single and Double Side Cooled

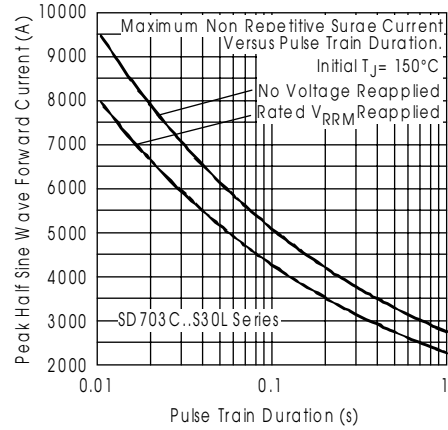

Fig. 16 - Maximum Non-repetitive Surge Current Single and Double Side Cooled

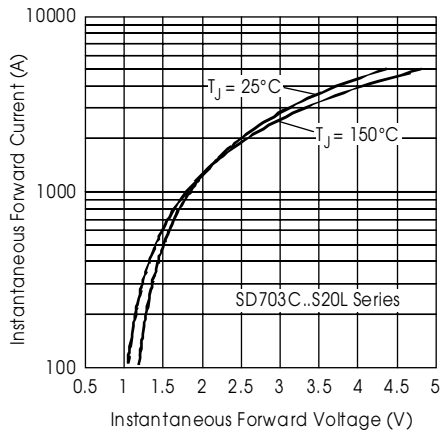

Fig. 17 - Forward Voltage Drop Characteristics

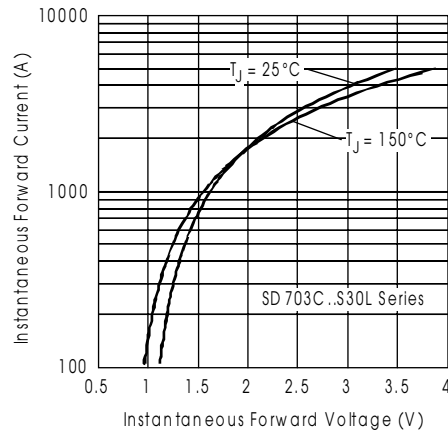

Fig. 18 - Forward Voltage Drop Characteristics

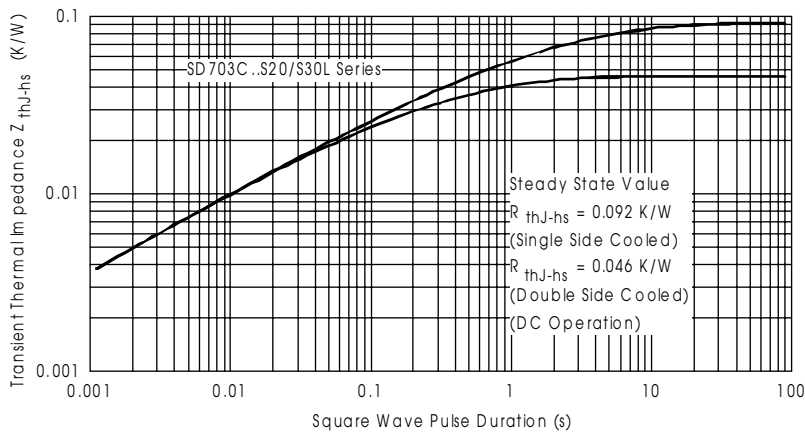

Fig. 19 - Thermal Impedance Z_{thJ-hs} Characteristic

SD703C..L Series

Bulletin I2075 rev. D 04/00

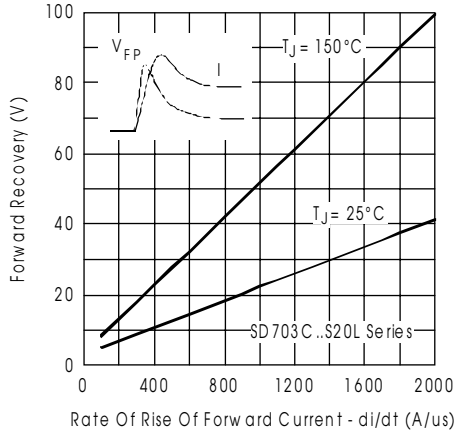

Fig. 20 - Typical Forward Recovery Characteristics

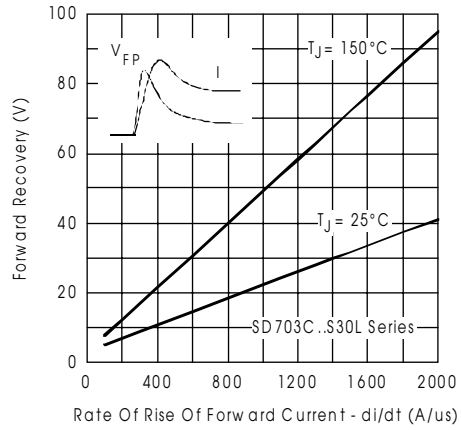

Fig. 21 - Typical Forward Recovery Characteristics

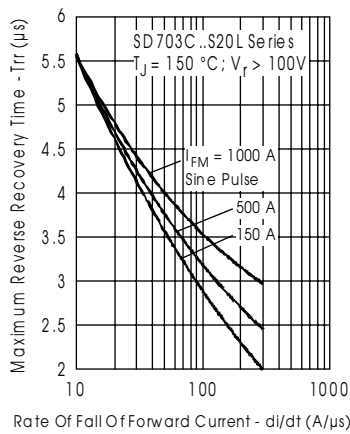

Fig. 22 - Recovery Time Characteristics

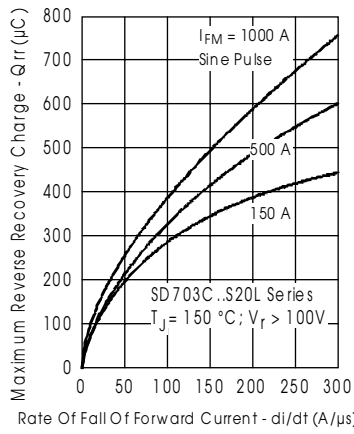

Fig. 23 - Recovery Charge Characteristics

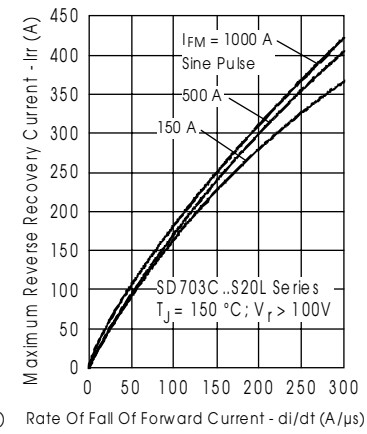

Fig. 24 - Recovery Current Characteristics

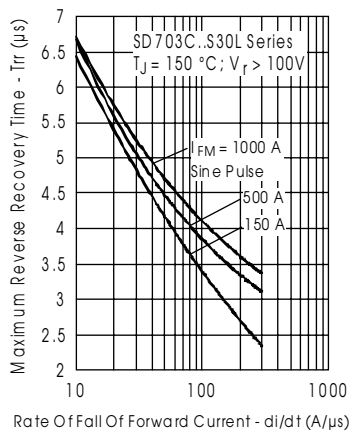

Fig. 25 - Recovery Time Characteristics

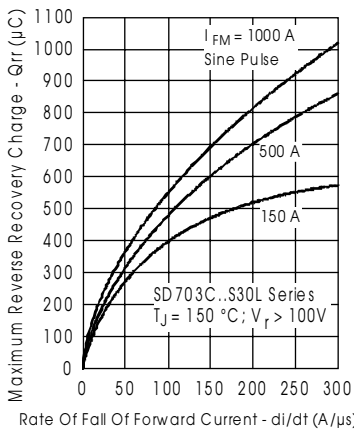

Fig. 26 - Recovery Charge Characteristics

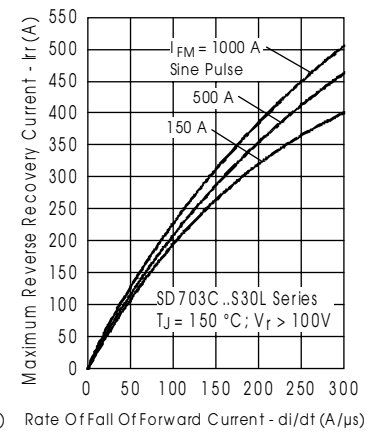

Fig. 27 - Recovery Current Characteristics

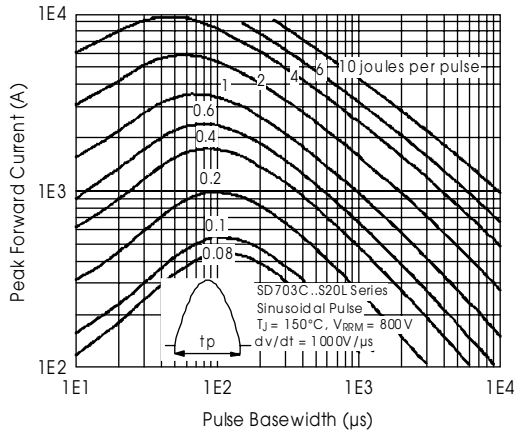

Fig. 28 - Maximum Total Energy Loss Per Pulse Characteristics

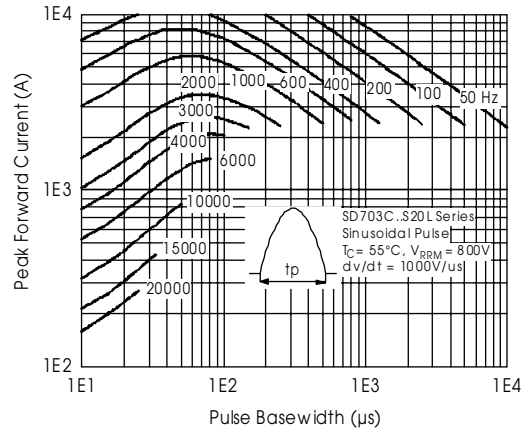

Fig. 29 - Frequency Characteristics

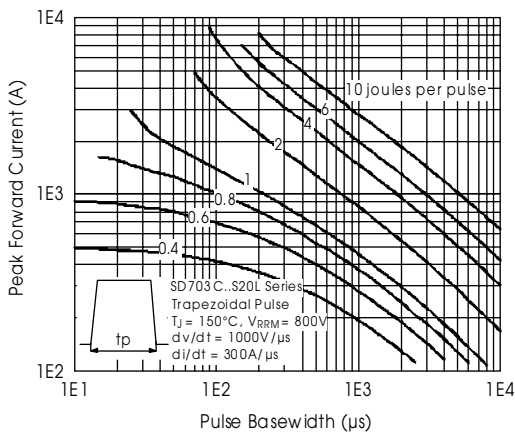

Fig. 30 - Maximum Total Energy Loss Per Pulse Characteristics

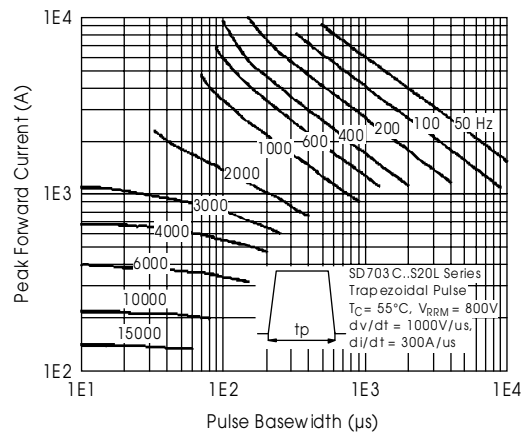

Fig. 31 - Frequency Characteristics

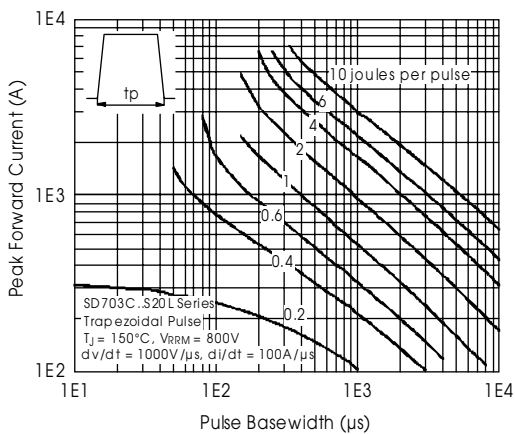

Fig. 32 - Maximum Total Energy Loss Per Pulse Characteristics

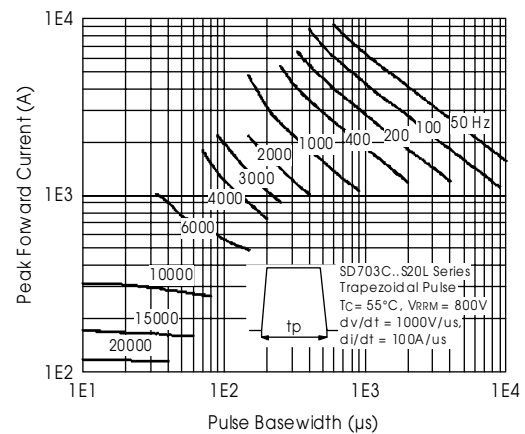

Fig. 33 - Frequency Characteristics

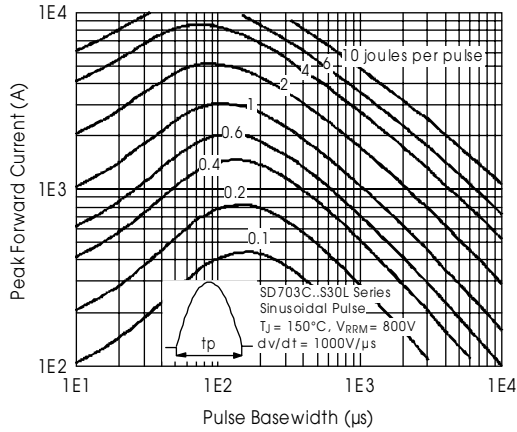

Fig. 34 - Maximum Total Energy Loss Per Pulse Characteristics

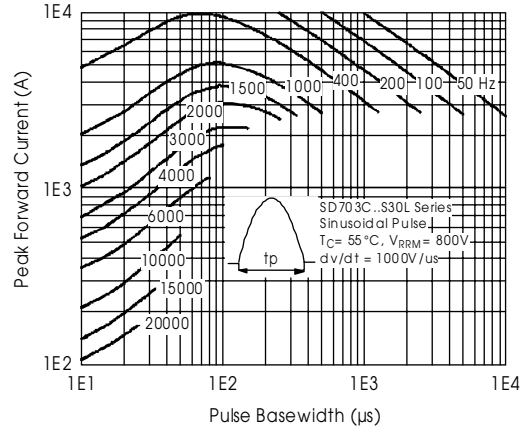

Fig. 35 - Frequency Characteristics

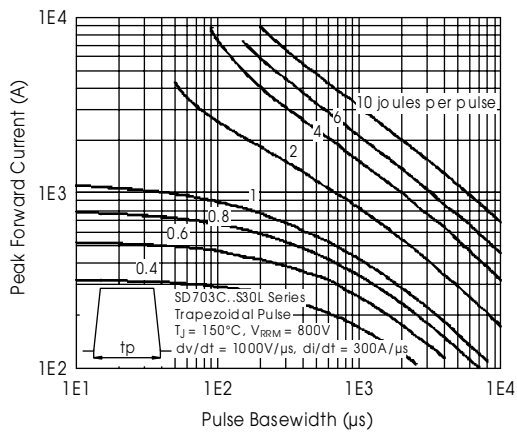

Fig. 36 - Maximum Total Energy Loss Per Pulse Characteristics

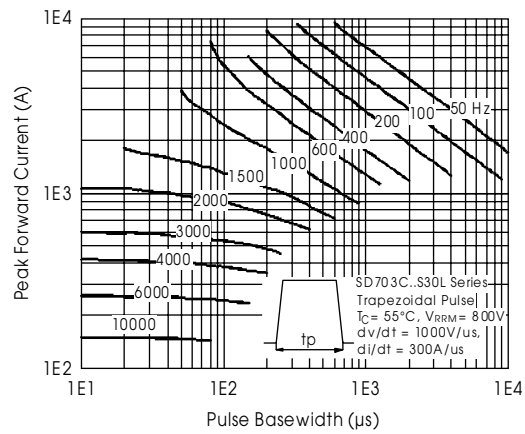

Fig. 37 - Frequency Characteristics

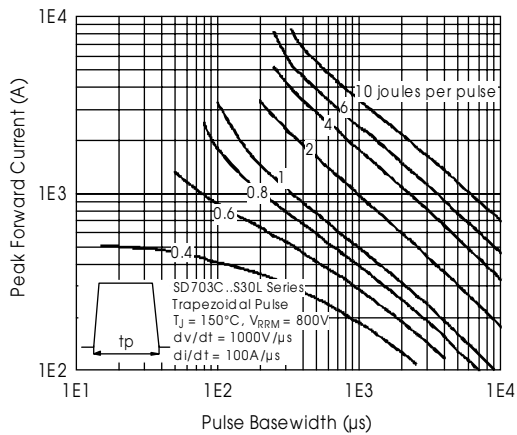

Fig. 38 - Maximum Total Energy Loss Per Pulse Characteristics

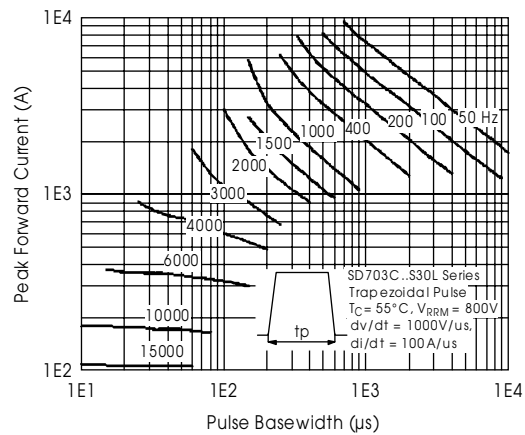

Fig. 39 - Frequency Characteristics