

ULTRA FAST RECOVERY RECTIFIER DIODES

FEATURES

- SUITED FOR SMPS
- LOW LOSSES
- LOW FORWARD AND REVERSE RECOVERY TIME
- HIGH SURGE CURRENT CAPABILITY
- HIGH AVALANCHE ENERGY CAPABILITY

DESCRIPTION

Low cost dual center tap rectifier suited for switch-mode power supply and high frequency DC to DC converters.

Packaged in TO220AB and ISOWATT220AB, this device is intended for use in low voltage, high frequency inverters, free wheeling and polarity protection applications.

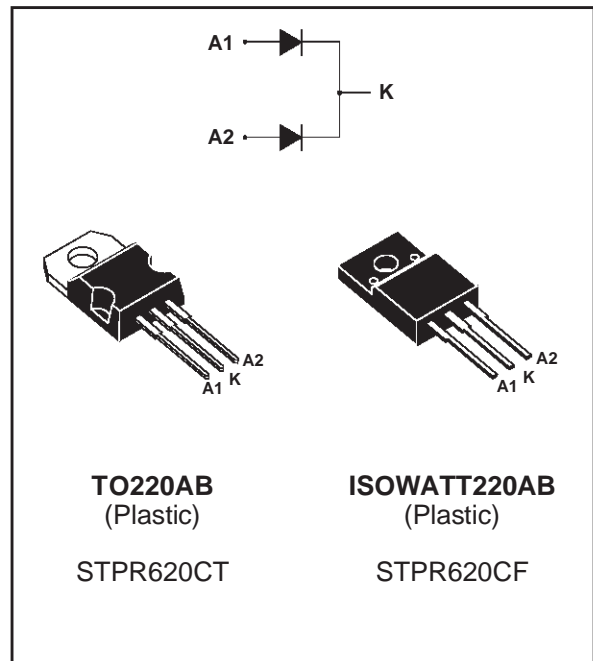

ABSOLUTE MAXIMUM (limiting values)

Symbol	Parameter			Value	Unit	
V_{RRM}	Repetitive peak reverse voltage			200	V	
$I_{F(RMS)}$	RMS forward current		Per diode	10	A	
$I_{F(AV)}$	Average forward current $\delta = 0.5$	TO220AB	$T_c = 125^\circ\text{C}$	Per diode	3	A
		ISOWATT220AB	$T_c = 120^\circ\text{C}$	Per device	6	
I_{FSM}	Surge non repetitive forward current		$t_p = 10\text{ms}$ sinusoidal	Per diode	30	A
T_{stg} T_j	Storage temperature range Maximum junction temperature			- 65 to + 150 - 65 to + 150	$^\circ\text{C}$ $^\circ\text{C}$	

STPR620CT/STPR620CF

THERMAL RESISTANCES

Symbol	Parameter		Value	Unit	
R _{th(j-c)}	Junction to case	TO220AB	Per diode	6.5	°C/W
		ISOWATT220AB	Per diode	8.5	

When the diodes 1 and 2 are used simultaneously :

$$\Delta T_j(\text{diode 1}) = P(\text{diode 1}) \times R_{th(j-c)} (\text{Per diode}) + P(\text{diode 2}) \times R_{th(c)}$$

ELECTRICAL CHARACTERISTICS

STATIC CHARACTERISTICS

Symbol	Test Conditions		Min.	Typ.	Max.	Unit
I _R *	T _j = 25°C	V _R = V _{RRM}			50	μA
	T _j = 100°C				0.6	mA
V _F **	T _j = 125°C	I _F = 3 A			0.99	V
	T _j = 125°C	I _F = 6 A			1.20	
	T _j = 25°C	I _F = 6 A			1.25	

Pulse test :

* t_p = 5 ms, δ < 2 %

** t_p = 380 μs, δ < 2 %

RECOVERY CHARACTERISTICS

Symbol	Test Conditions		Min.	Typ.	Max.	Unit
t _{rr}	T _j = 25°C	I _F = 0.5A I _R = 1A			30	ns
t _{fr}	T _j = 25°C	I _F = 1A V _{FR} = 1.1 x V _F		20		ns
V _{FP}	T _j = 25°C	I _F = 1A		3		V

To evaluate the conduction losses use the following equation :

$$P = 0.78 \times I_{F(AV)} + 0.070 \times I_{F(RMS)}^2$$

Fig.1 : Average forward power dissipation versus average forward current (Per diode).

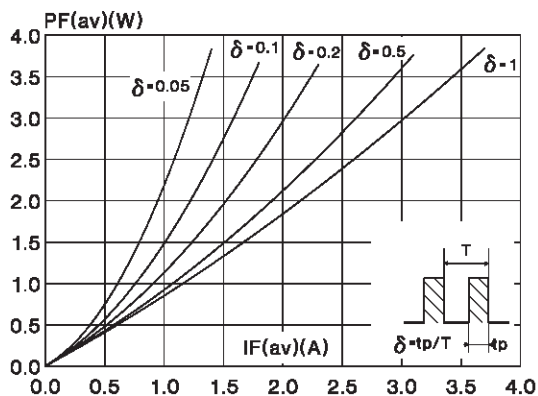

Fig.2 : Peak current versus form factor. (Per diode)

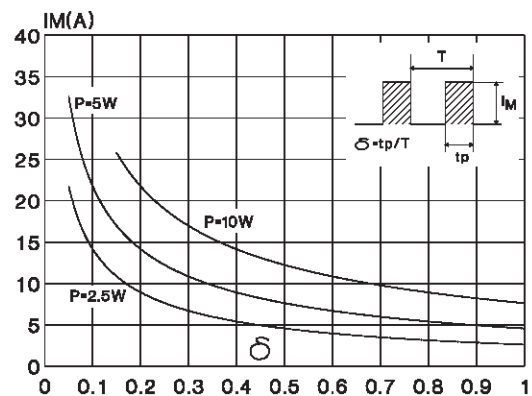

Fig.3 : Average current versus ambient temperature. (duty cycle : 0.5) (TO220AB)

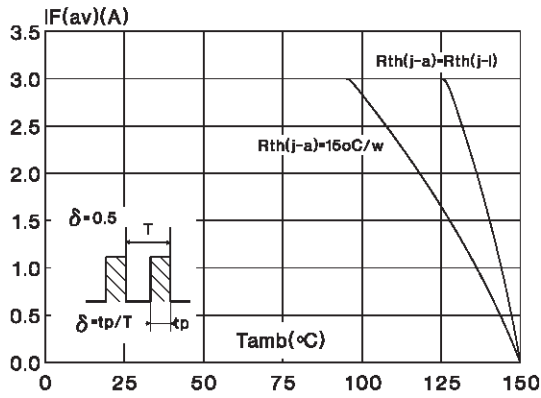

Fig.4 : Average current versus ambient temperature. (duty cycle : 0.5) (ISOWATT220AB)

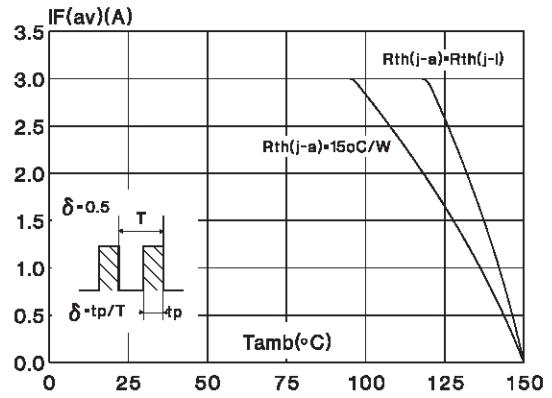

Fig.5 : Non repetitive surge peak forward current versus overload duration (Maximum values) (Per diode) (TO220AB).

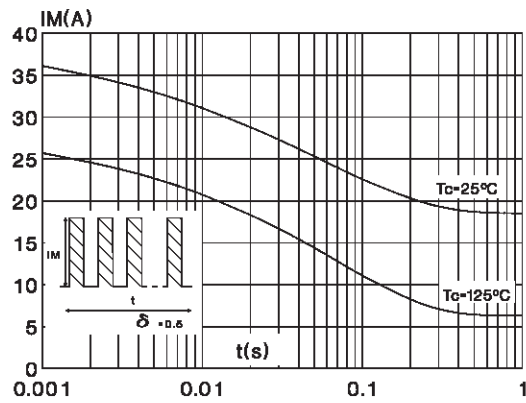

Fig.6 : Non repetitive surge peak forward current versus overload duration (Maximum values) (Per diode) (ISOWATT220AB).

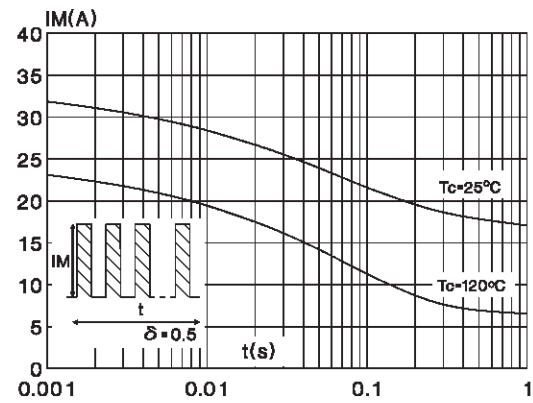

Fig.7 : Relative variation of thermal transient impedance junction to case versus pulse duration (Per diode) (TO220AB).

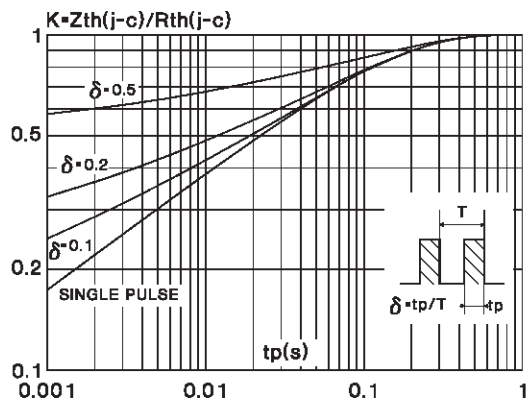
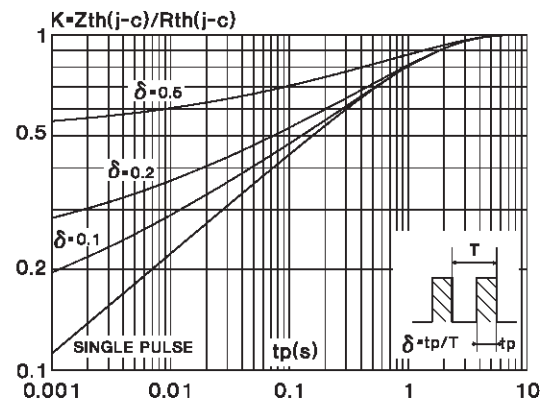

Fig.8 : Relative variation of thermal transient impedance junction to case versus pulse duration (Per diode) (ISOWATT220AB).



STPR620CT/STPR620CF

Fig.9 : Forward voltage drop versus forward current. (maximum values) (Per diode).

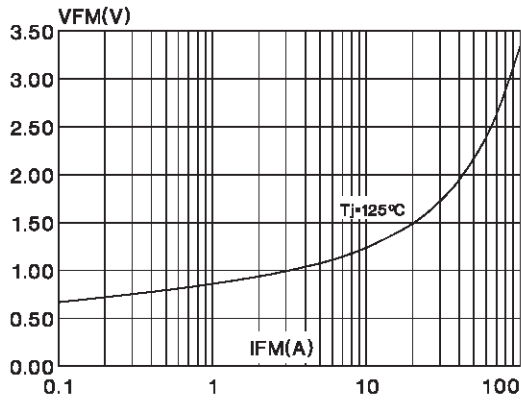

Fig.10 : Junction capacitance versus reverse voltage applied (Typical values) (Per diode).

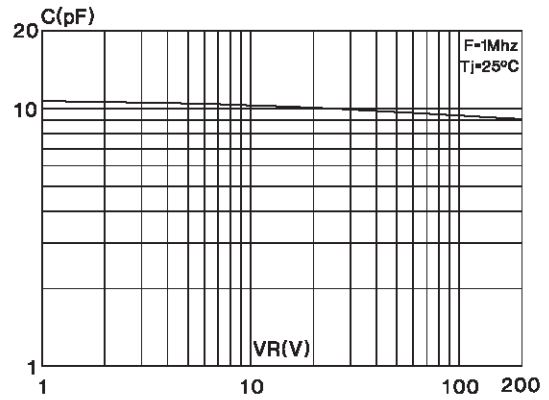

Fig. 11: Recovery charges versus dI_F/dt (Per diode).

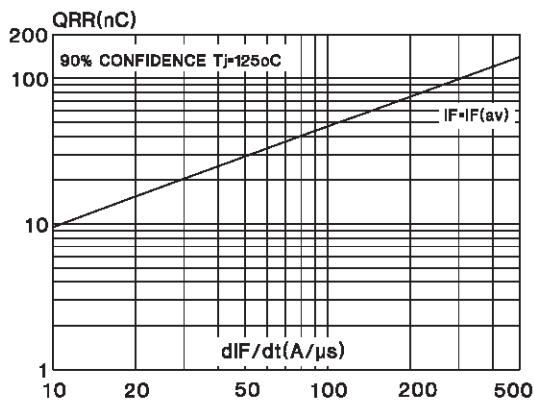

Fig.12 : Peak reverse current versus dI_F/dt (Per diode).

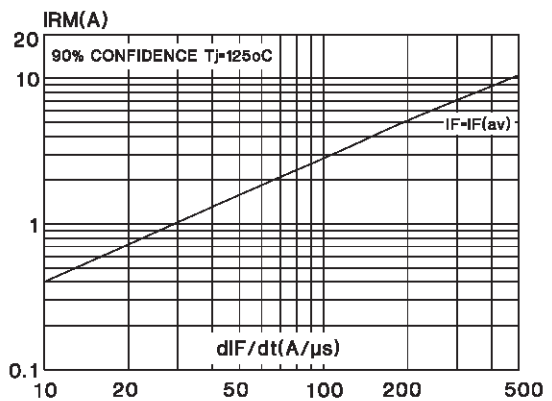
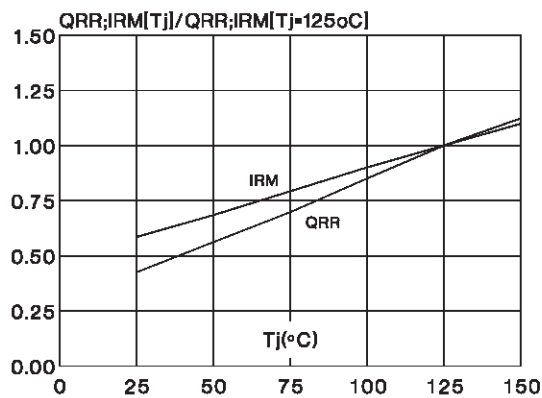
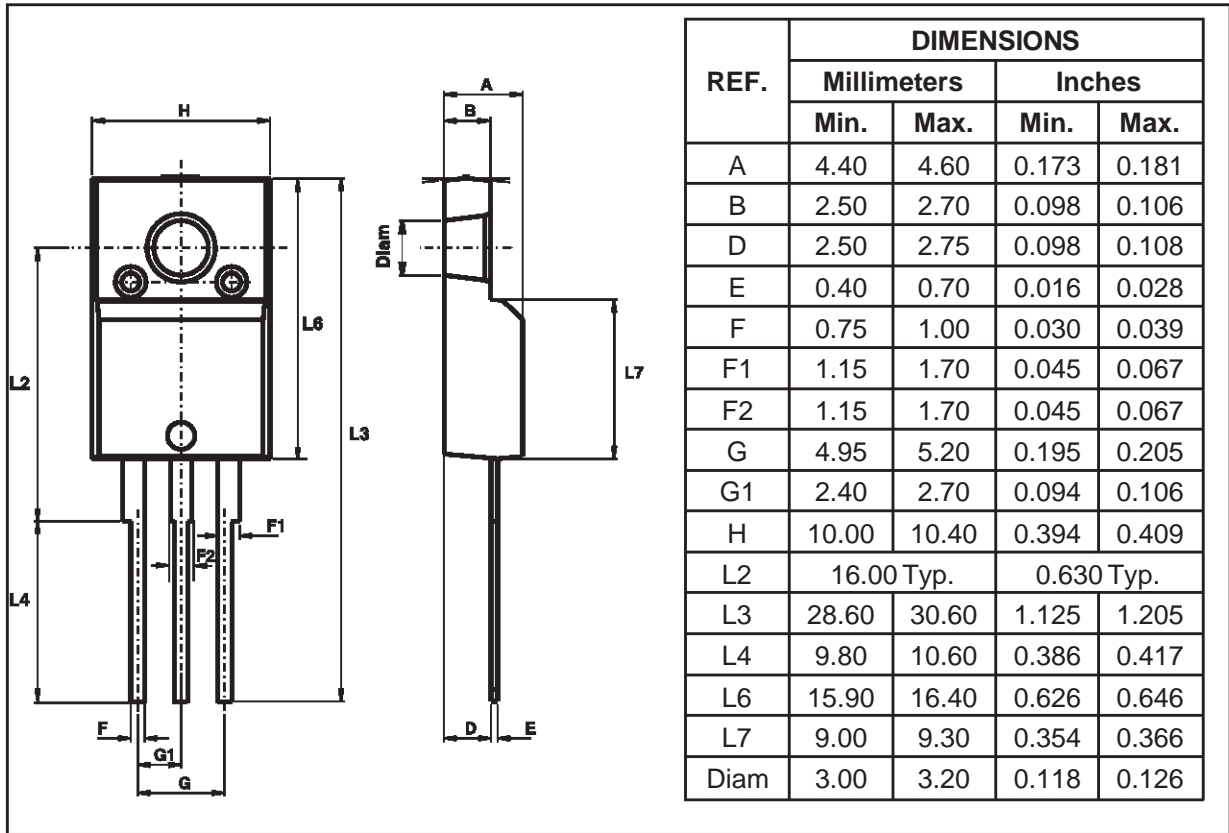

Fig.13 : Dynamic parameters versus junction temperature (Per diode).



PACKAGE MECHANICAL DATA
ISOWATT220AB (JEDEC outline)



Cooling method : C
Marking : Type number
Weight : 2.08 g

Recommended torque value : 0.55m.N
Maximum torque value : 0.70m.N

STPR620CT/STPR620CF

PACKAGE MECHANICAL DATA
TO220AB (JEDEC outline)

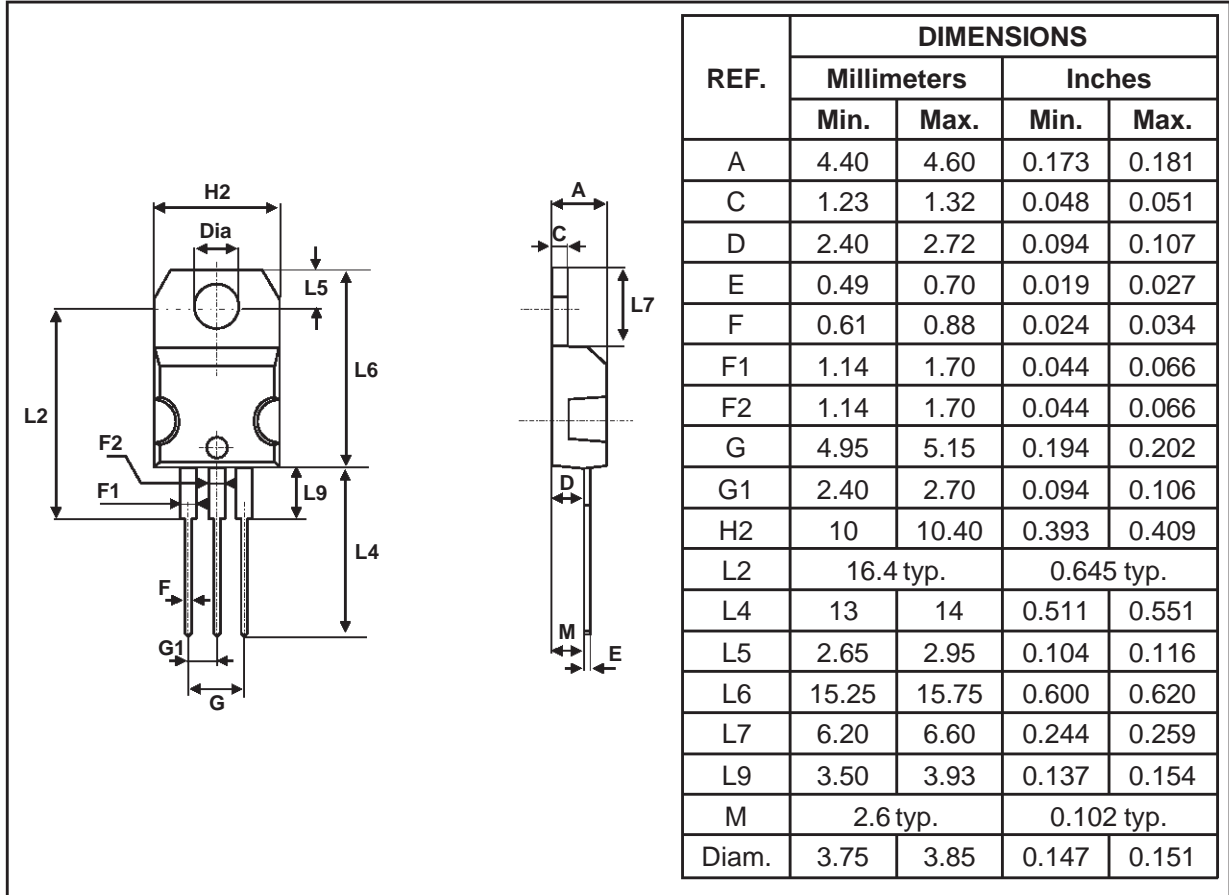

Cooling method : C
Marking : Type number
Weight : 2.23 g

Recommended torque value : 0.8m.N
Maximum torque value : 1.0m.N

Information furnished is believed to be accurate and reliable. However, STMicroelectronics assumes no responsibility for the consequences of use of such information nor for any infringement of patents or other rights of third parties which may result from its use. No license is granted by implication or otherwise under any patent or patent rights of STMicroelectronics. Specifications mentioned in this publication are subject to change without notice. This publication supersedes and replaces all information previously supplied. STMicroelectronics products are not authorized for use as critical components in life support devices or systems without express written approval of STMicroelectronics.

The ST logo is a registered trademark of STMicroelectronics

© 1998 STMicroelectronics - Printed in Italy - All rights reserved.

STMicroelectronics GROUP OF COMPANIES

Australia - Brazil - Canada - China - France - Germany - Italy - Japan - Korea - Malaysia - Malta - Mexico - Morocco - The Netherlands - Singapore - Spain - Sweden - Switzerland - Taiwan - Thailand - United Kingdom - U.S.A.