



STPS640CT/CF/CB

POWER SCHOTTKY RECTIFIER

MAIN PRODUCT CHARACTERISTICS

$I_{F(AV)}$	2 x 3 A
V_{RRM}	40 V
$T_j(\text{max})$	150 °C
$V_F(\text{max})$	0.57 V

FEATURES AND BENEFITS

- VERY SMALL CONDUCTION LOSSES
- NEGLIGIBLE SWITCHING LOSSES
- EXTREMELY FAST SWITCHING
- LOW FORWARD DROP VOLTAGE
- LOW CAPACITANCE
- LOW THERMAL RESISTANCE
- INSULATED PACKAGE:
Insulating voltage = 2000V DC
Capacitance = 12pF
- SMD PACKAGE (tape and reel option: -TR)

DESCRIPTION

Dual Schottky rectifier suited to Switch Mode Power Supplies and other Power Converters.

This device is intended for use in low and medium voltage operation, and particularly, in high frequency circuitries where low switching losses are required (free wheeling and polarity protection).

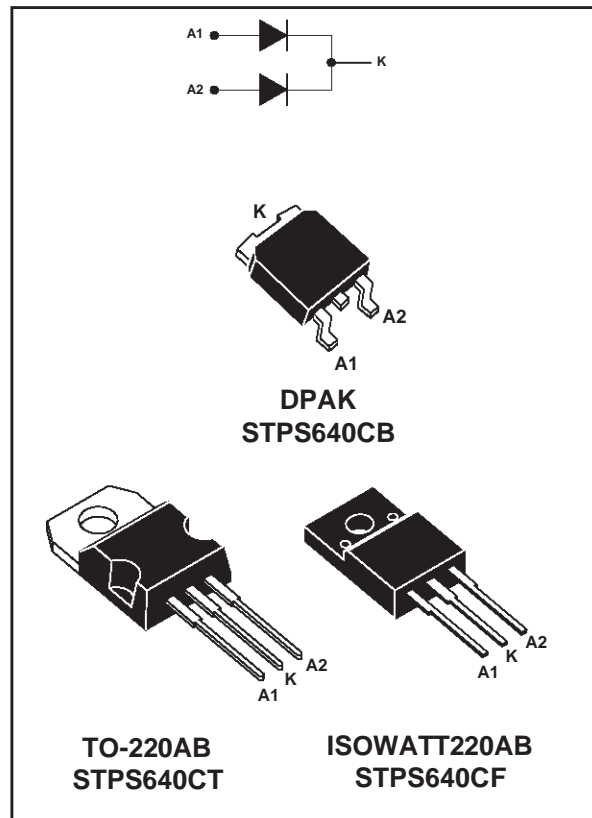

ABSOLUTE RATINGS (limiting values, per diode)

Symbol	Parameter		Value	Unit
V_{RRM}	Repetitive peak reverse voltage		40	V
$I_{F(RMS)}$	RMS forward current	TO-220AB / ISOWATT220AB	10	A
		DPAK	6	
$I_{F(AV)}$	Average forward current $\delta = 0.5$	TO-220AB	3	A
		ISOWATT220AB		
		DPAK	$T_c = 120^\circ\text{C}$	
I_{FSM}	Surge non repetitive forward current	tp = 10 ms Sinusoidal	75	A
I_{RRM}	Repetitive peak reverse current	tp = 2 μs F = 1kHz square	1	A
T_{stg}	Storage temperature range		- 65 to + 150	°C
T_j	Maximum operating junction temperature		150	°C
dV/dt	Critical rate of rise of reverse voltage		10000	V/ μs

STPS640CT/CF/CB

THERMAL RESISTANCES

Symbol	Parameter		Value	Unit	
$R_{th(j-c)}$	Junction to case	TO-220AB/DPAK	Per diode Total	5.5 3	°C/W
		ISOWATT220AB	Per diode Total		
$R_{th(c)}$	Coupling	TO-220AB		0.5	°C/W
		ISOWATT220AB		3	

When the diodes 1 and 2 are used simultaneously:

$$\Delta T_j(\text{diode 1}) = P(\text{diode 1}) \times R_{th(j-c)}(\text{Per diode}) + P(\text{diode 2}) \times R_{th(c)}$$

STATIC ELECTRICAL CHARACTERISTICS (per diode)

Symbol	Tests Conditions		Min.	Typ.	Max.	Unit	
I_R^*	Reverse leakage current	$T_j = 25^\circ\text{C}$	$V_R = V_{RRM}$		100	μA	
		$T_j = 125^\circ\text{C}$		2	10	mA	
V_F^*	Forward voltage drop	$T_j = 25^\circ\text{C}$	$I_F = 3\text{ A}$		0.63	V	
		$T_j = 25^\circ\text{C}$		$I_F = 6\text{ A}$			0.84
		$T_j = 125^\circ\text{C}$		$I_F = 3\text{ A}$	0.5		0.57
		$T_j = 125^\circ\text{C}$		$I_F = 6\text{ A}$	0.67		0.72

Pulse test : * $t_p = 380\ \mu\text{s}$, $\delta < 2\%$

To evaluate the maximum conduction losses use the following equation :

$$P = 0.42 \times I_{F(AV)} + 0.050 I_{F(RMS)}^2$$

Fig. 1: Average forward power dissipation versus average forward current (per diode).

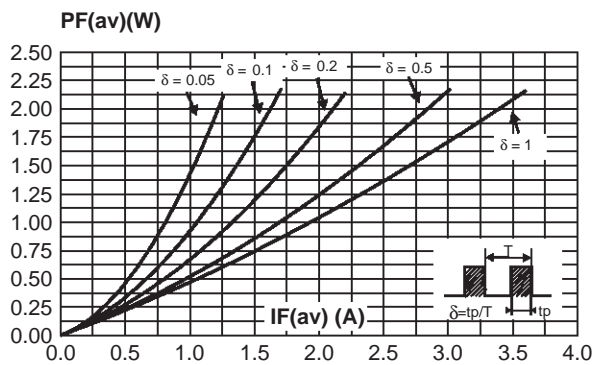

Fig. 2: Average current versus ambient temperature ($\delta = 0.5$, per diode).

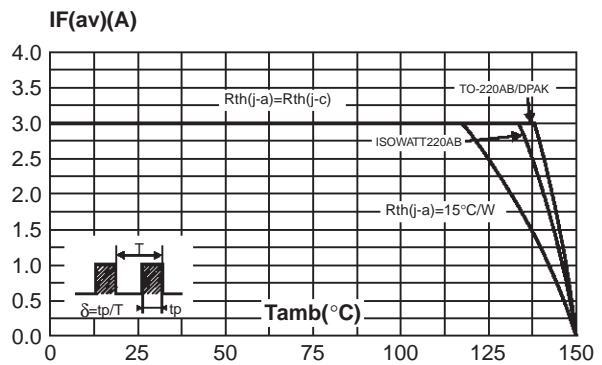

Fig. 3-1: Non repetitive surge peak forward current versus overload duration. (Maximum values, per diode) (TO-220AB/ DPAK).

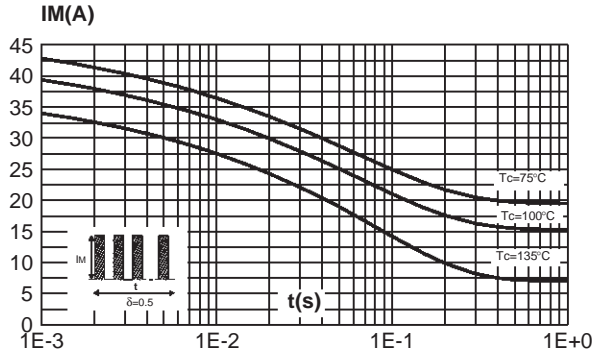

Fig. 3-2: Non repetitive surge peak forward current versus overload duration. (Maximum values, per diode) (ISOWATT220AB).

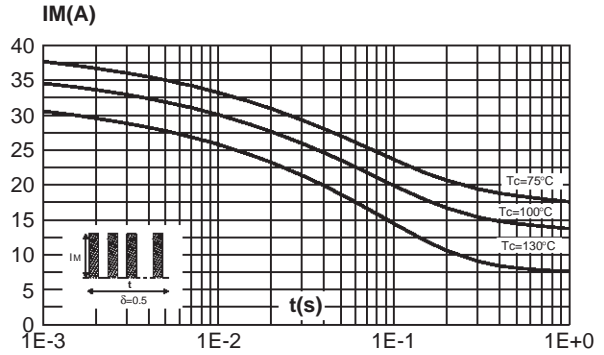

Fig. 4.1: Relative variation of thermal transient impedance junction to case versus pulse duration (TO-220AB/ DPAK).

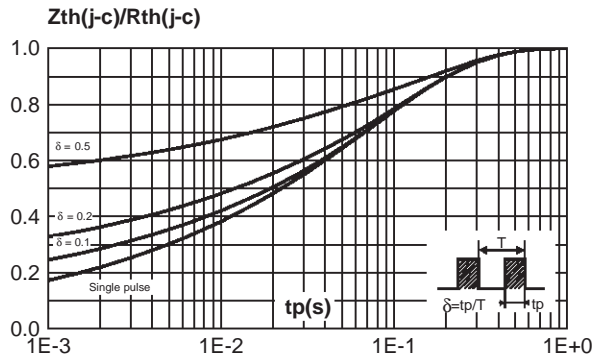

Fig. 4-2: Relative variation of thermal transient impedance junction to case versus pulse duration (ISOWATT220AB).

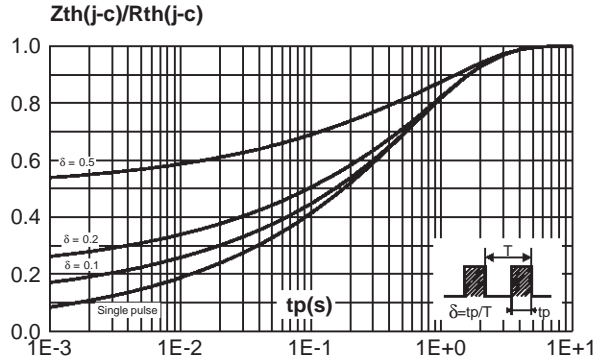

Fig. 5: Reverse leakage current versus reverse voltage applied (typical values, per diode).

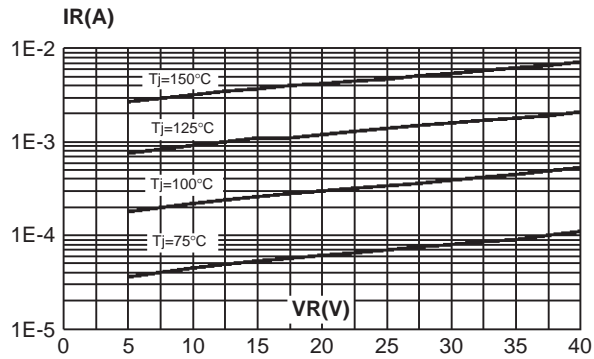
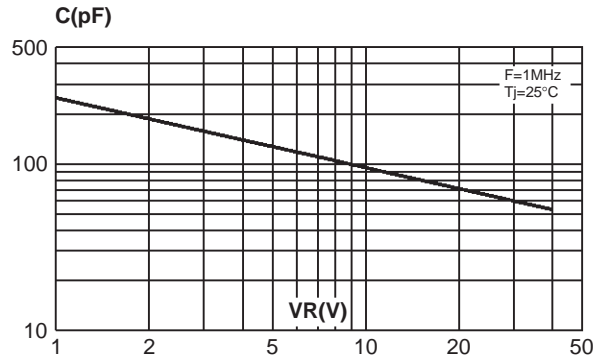

Fig. 6: Junction capacitance versus reverse voltage applied (typical values, per diode).



STPS640CT/CF/CB

Fig. 7: Forward voltage drop versus forward current (maximum values, per diode).

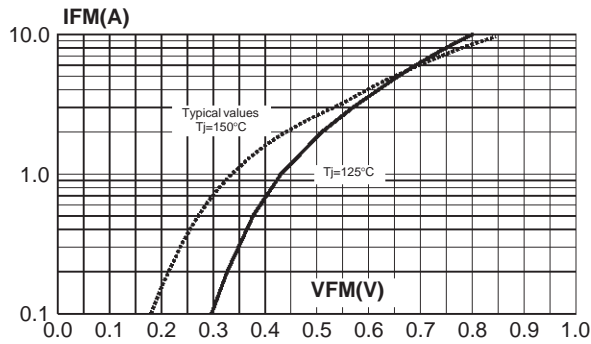
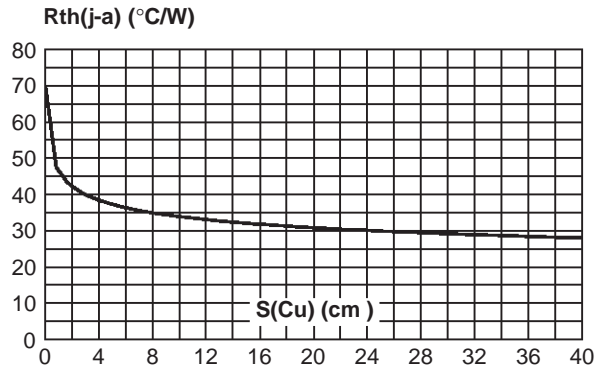
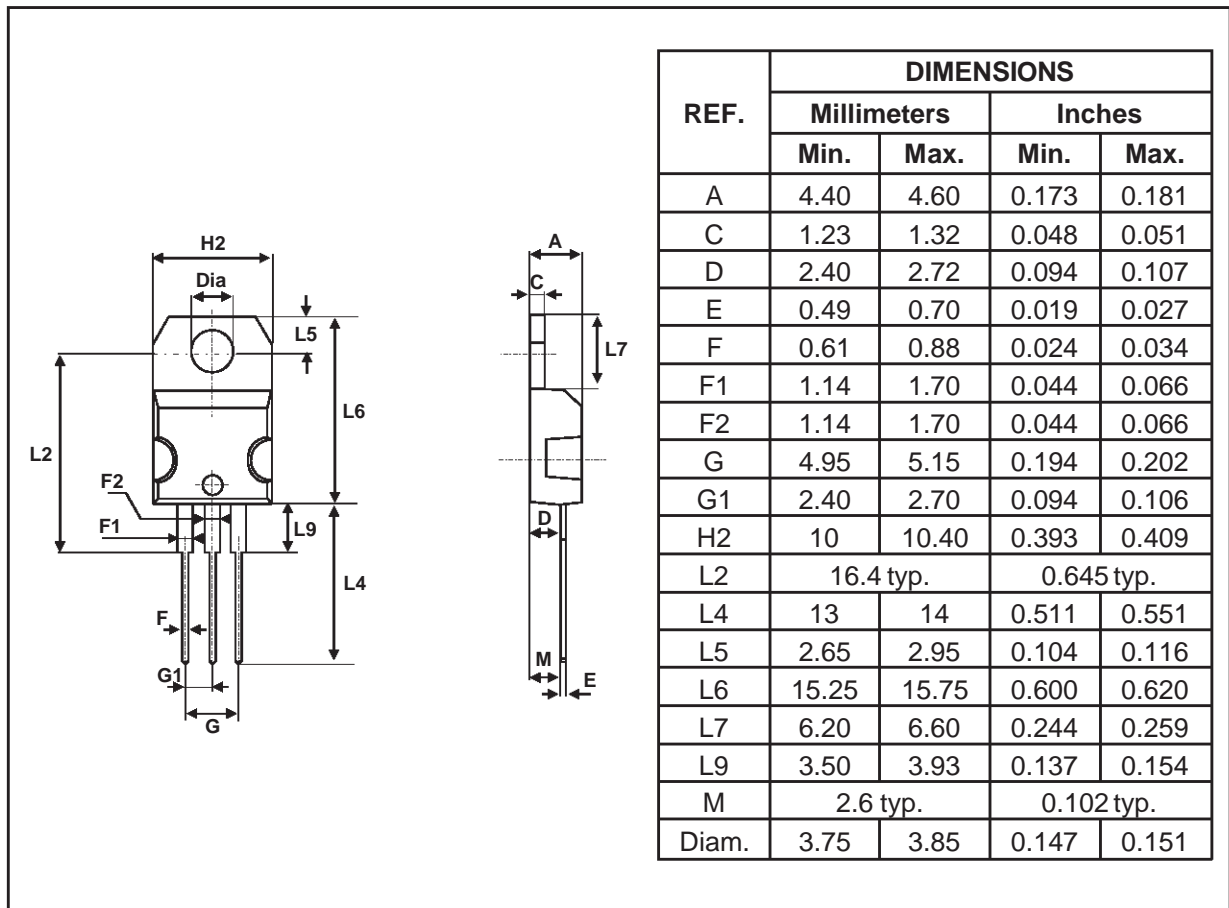

Fig. 8: Thermal resistance junction to ambient versus copper surface under tab (Epoxy printed circuit board FR4, copper thickness: 35µm).



PACKAGE MECHANICAL DATA TO-220AB



PACKAGE MECHANICAL DATA
DPAK

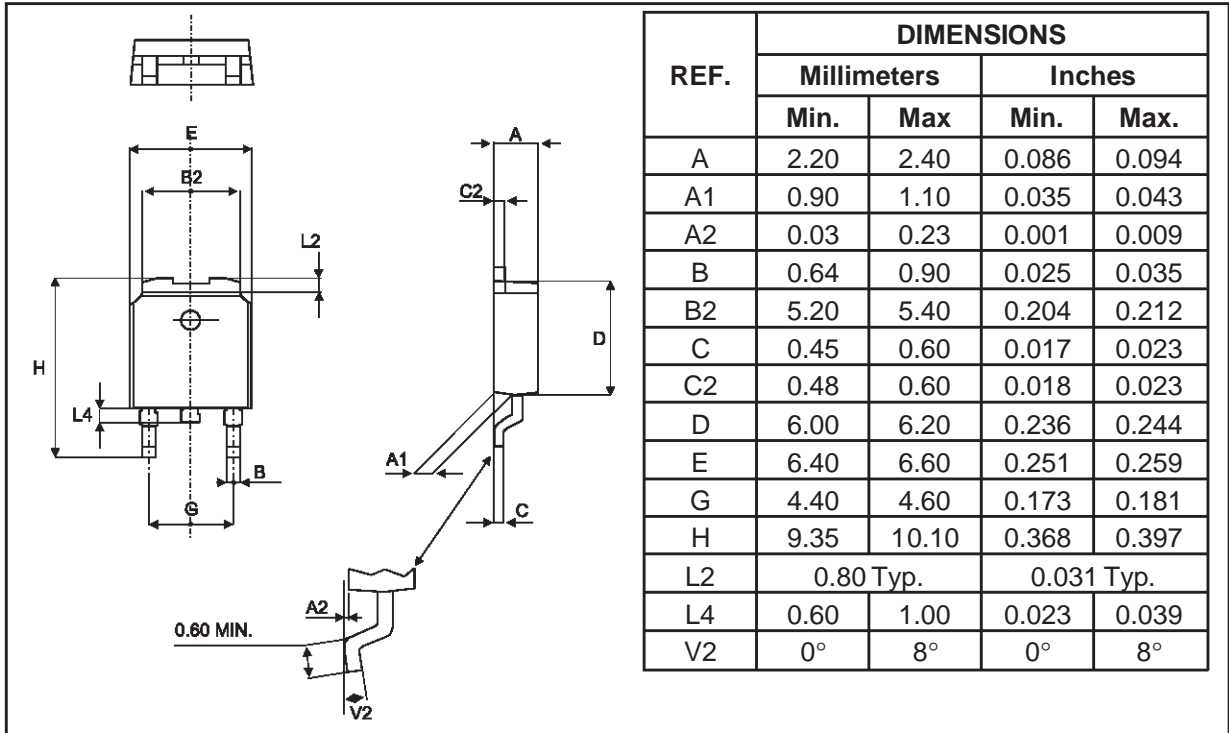

FOOTPRINT DIMENSIONS (in millimeters)

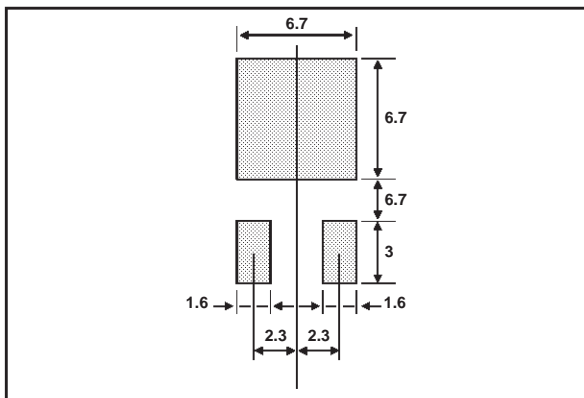

STPS640CT/CF/CB

PACKAGE MECHANICAL DATA ISOWATT220AB

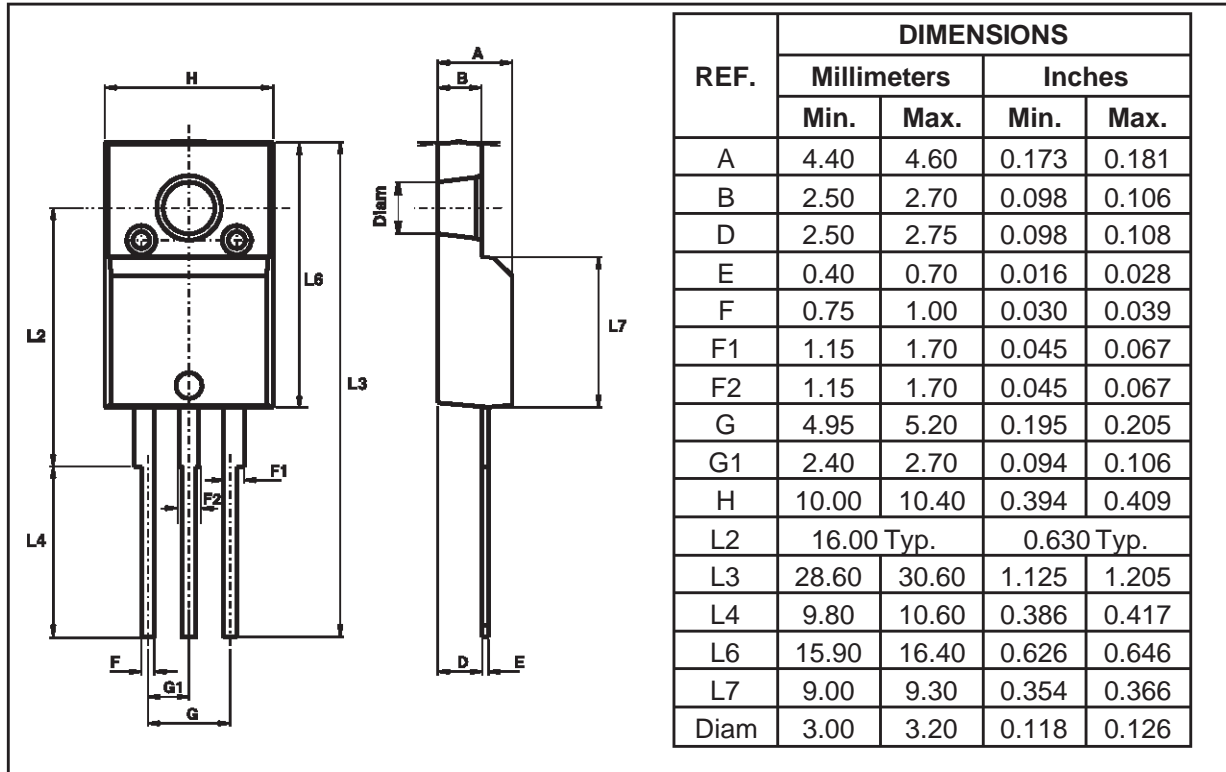

Ordering type	Marking	Package	Weight	Base qty	Delivery mode
STPS640CT	STPS640CT	TO-220AB	2.20g	50	Tube
STPS640CB	S640C	DPAK	0.30g	75	Tube
STPS640CB-TR	S640C	DPAK	0.30g	2500	Tape and reel
STPS640CF	STPS640CF	ISOWATT220AB	2.08g	50	Tube

■ Epoxy meets UL94,V0

Information furnished is believed to be accurate and reliable. However, STMicroelectronics assumes no responsibility for the consequences of use of such information nor for any infringement of patents or other rights of third parties which may result from its use. No license is granted by implication or otherwise under any patent or patent rights of STMicroelectronics. Specifications mentioned in this publication are subject to change without notice. This publication supersedes and replaces all information previously supplied. STMicroelectronics products are not authorized for use as critical components in life support devices or systems without express written approval of STMicroelectronics.

The ST logo is a registered trademark of STMicroelectronics

© 1998 STMicroelectronics - Printed in Italy - All rights reserved.

STMicroelectronics GROUP OF COMPANIES

Australia - Brazil - Canada - China - France - Germany - Italy - Japan - Korea - Malaysia - Malta - Mexico - Morocco - The Netherlands - Singapore - Spain - Sweden - Switzerland - Taiwan - Thailand - United Kingdom - U.S.A.

<http://www.st.com>