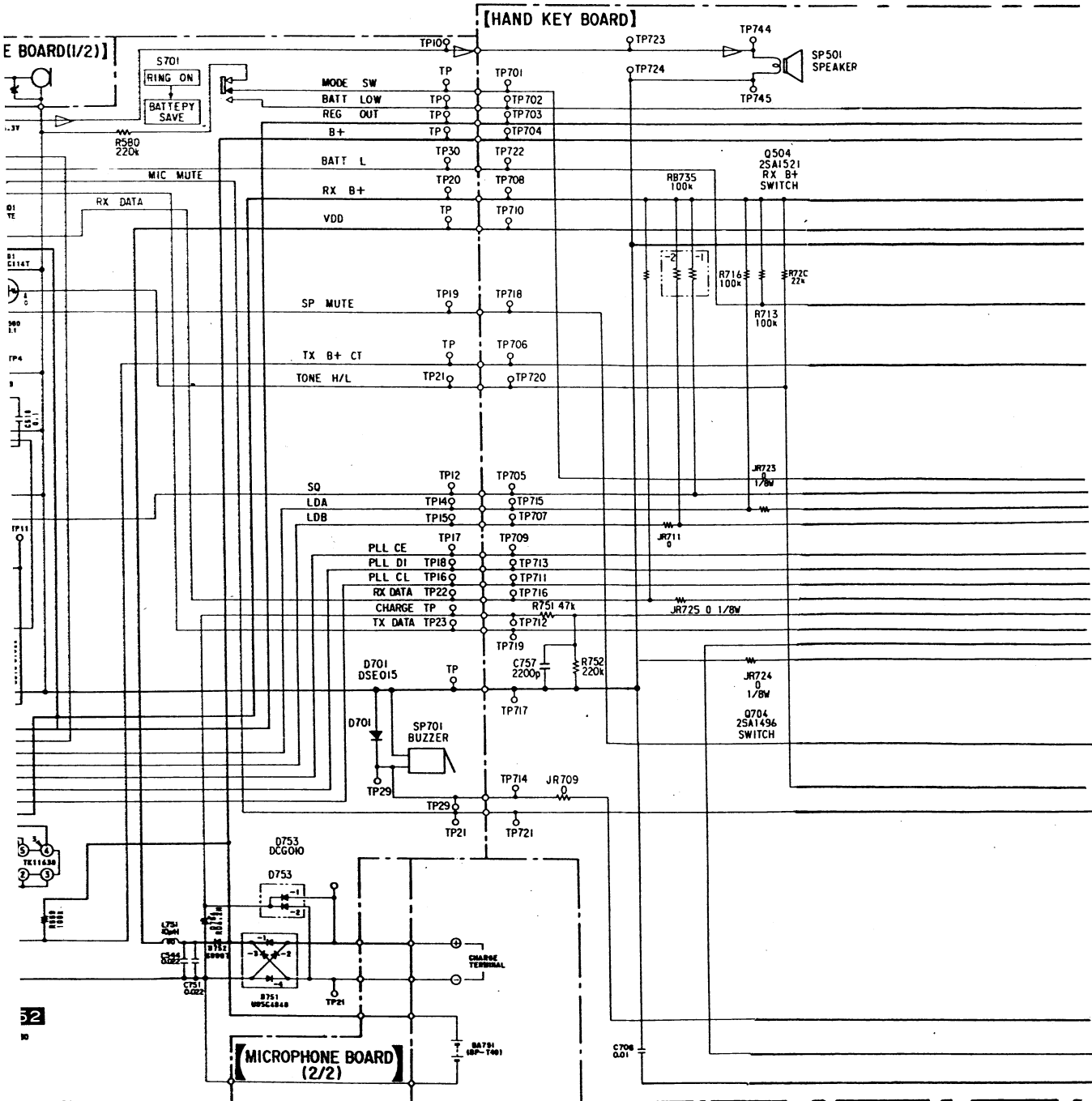

Table with 4 columns: Ref. NO., US, Canadian, E92 MODEL, E4 MODEL, and Taiwan MODEL. It lists component values for resistors R524, R603, R604, and R607.

Ref. NO.	US, Canadian, E92 MODEL	E4 MODEL	Taiwan MODEL
R524	1.5k	2.7k	2.7k
R603	4.7k	10k	10k
R604	1.0k	60k	47k
R607	2.2k	2.7k	2.7k

A  
B  
C  
D  
E  
F  
G  
H  
I

1 2 3 4 5 6 7 8



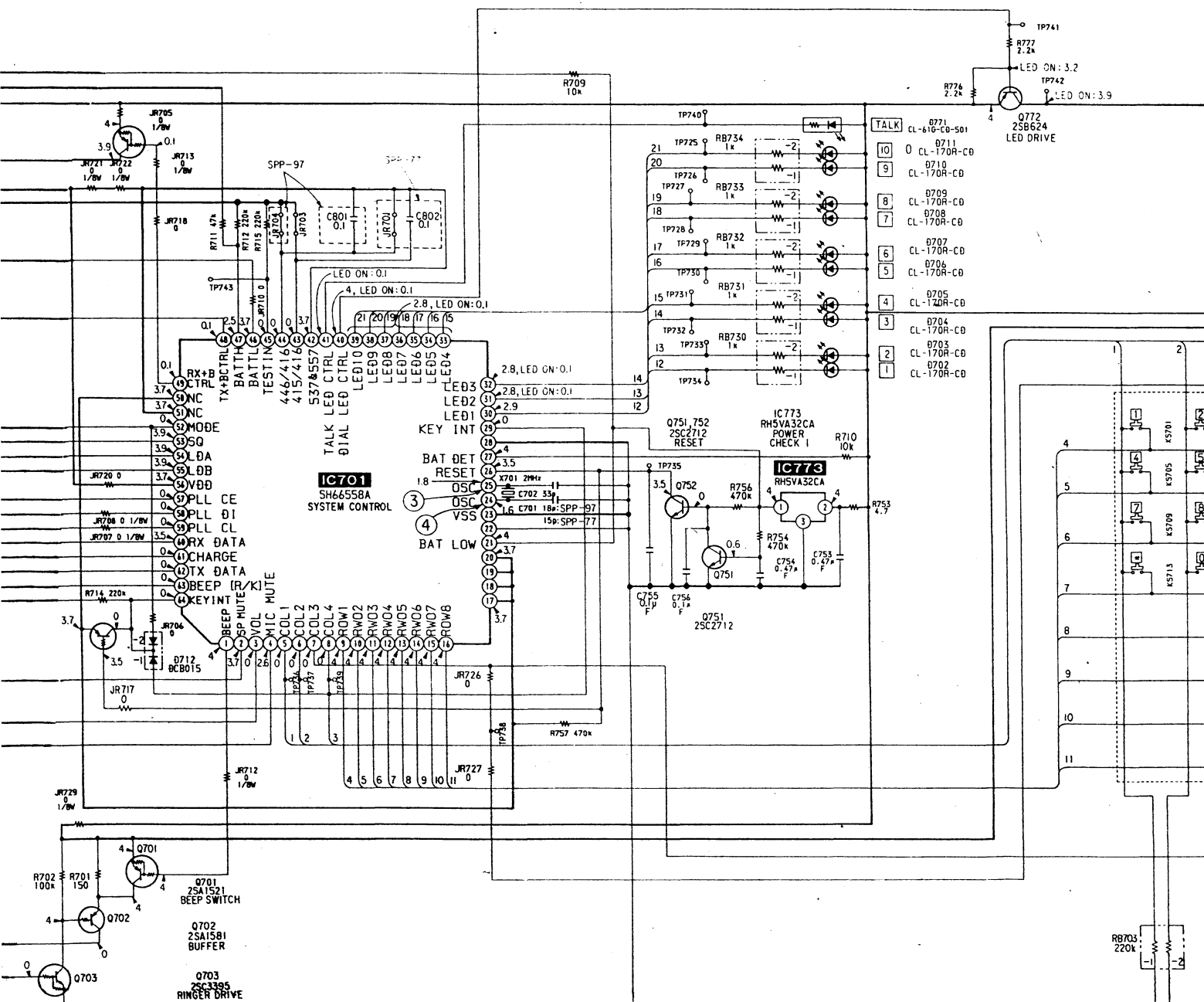

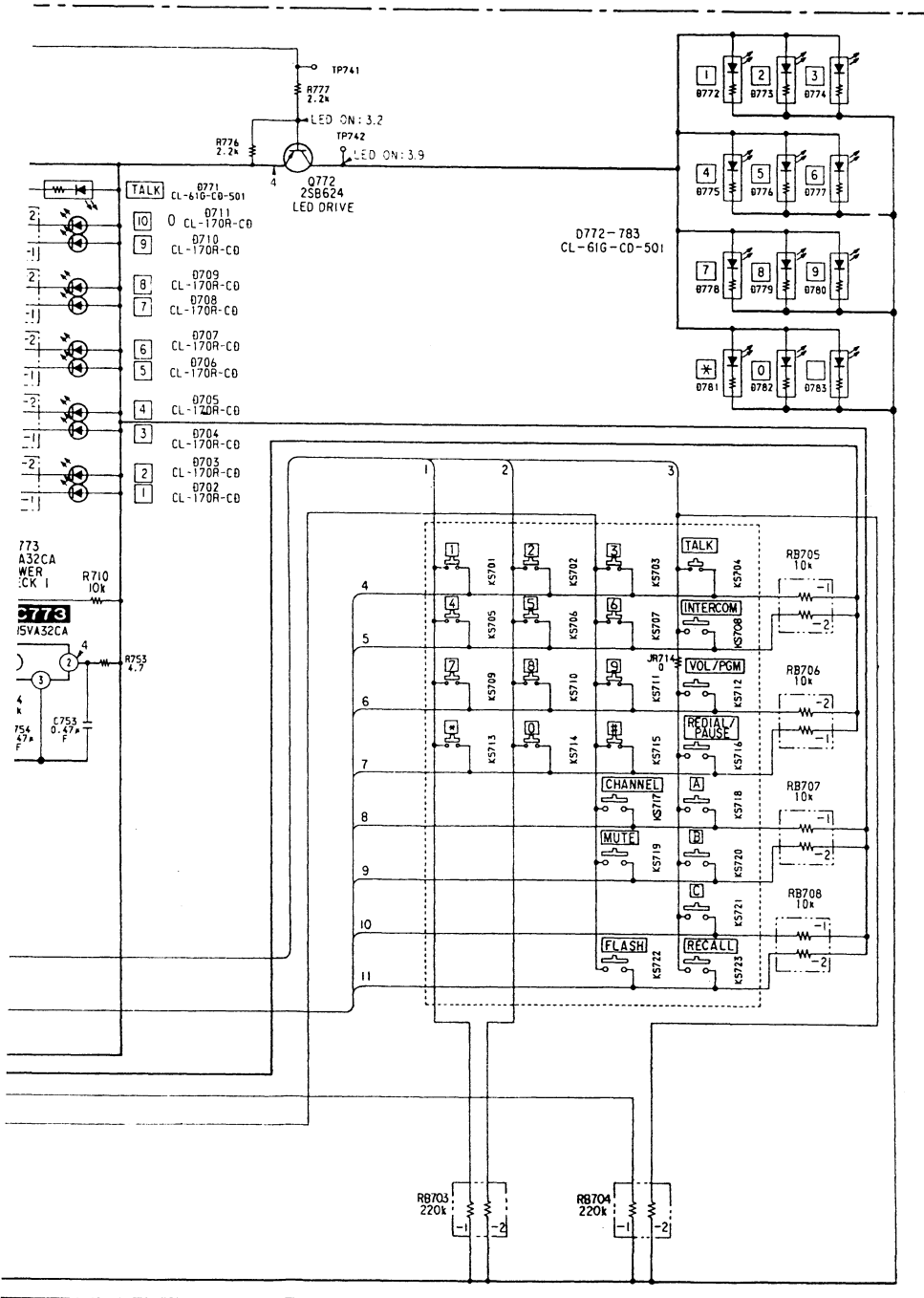

### • WAVEFORMS

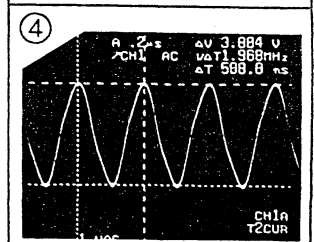
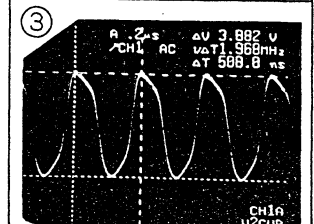
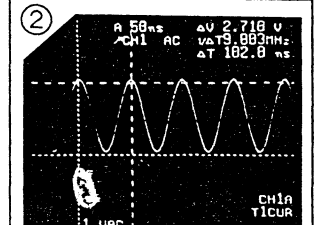
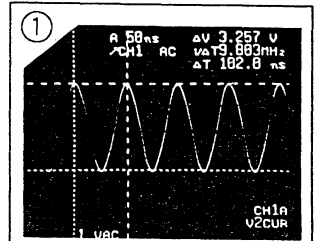

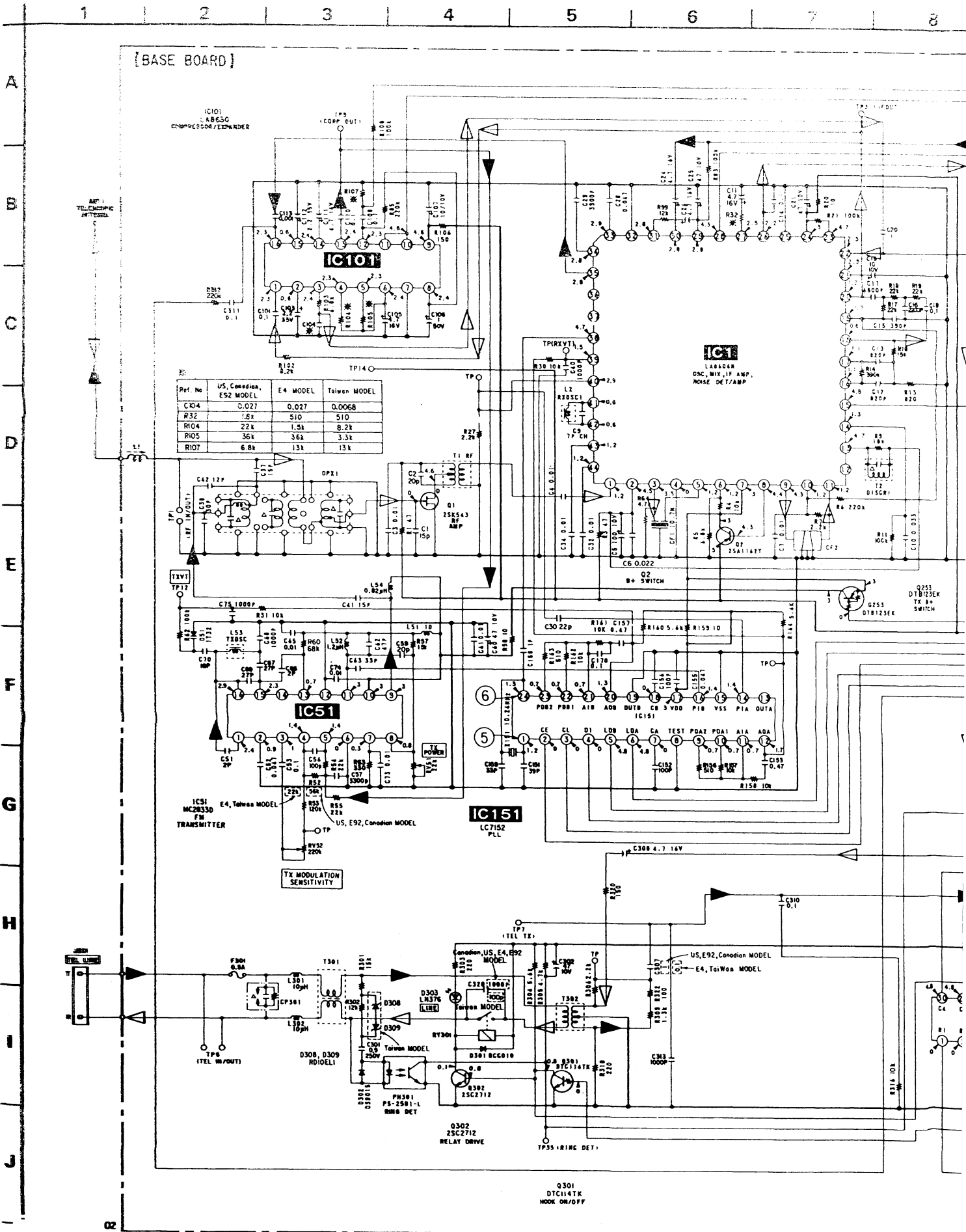

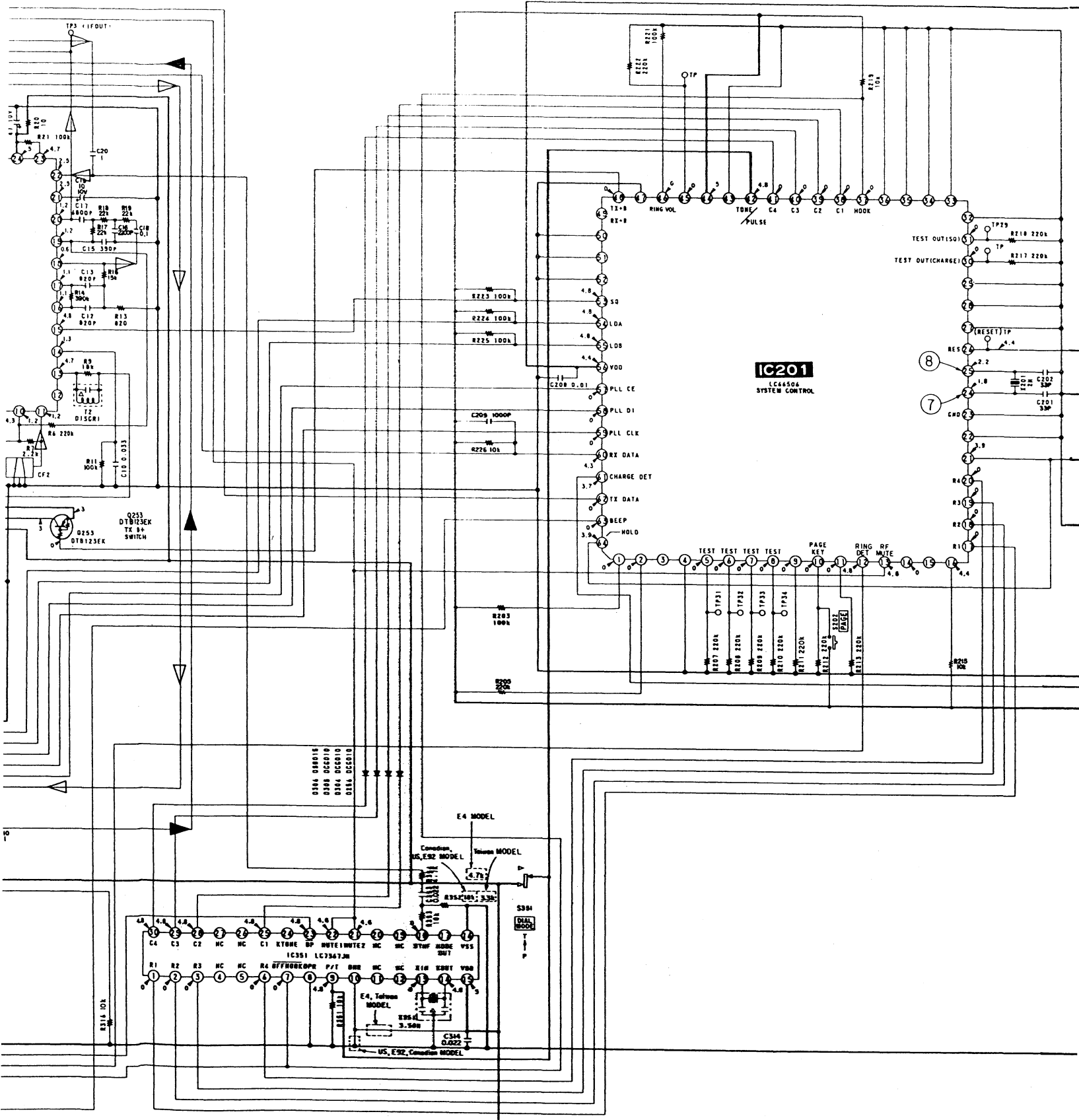

**IC351**  
DIALER

16 17 18 19

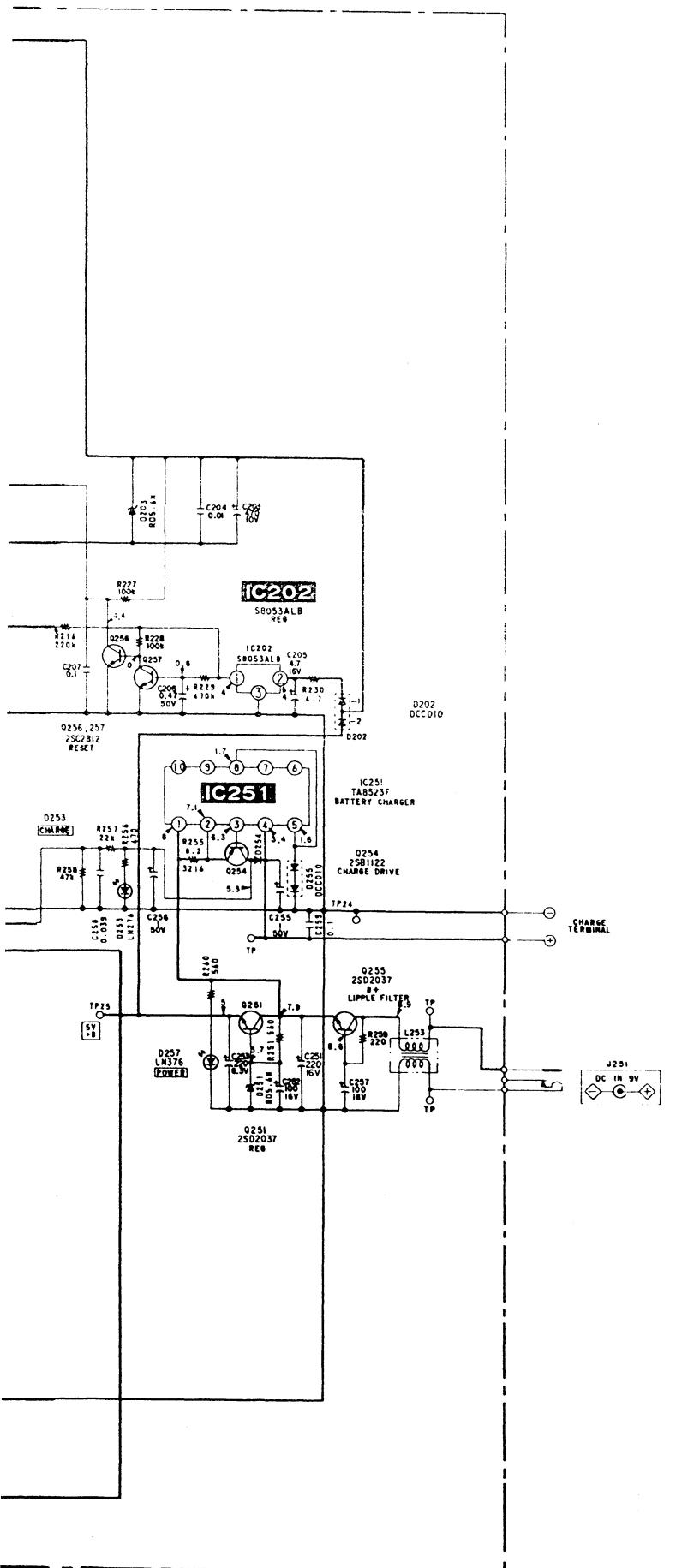

• WAVEFORMS

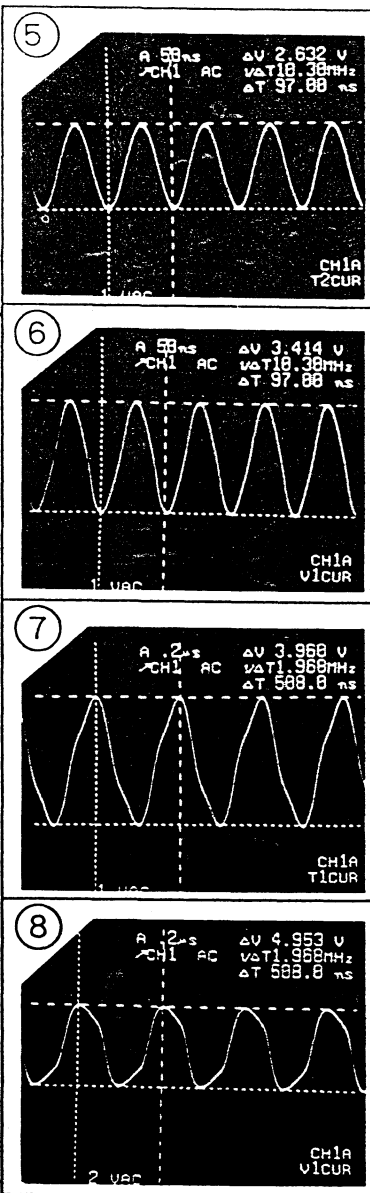

1 2

A  
B  
C  
D  
E  
F  
G  
H  
I  
J

[BASE BOARD]

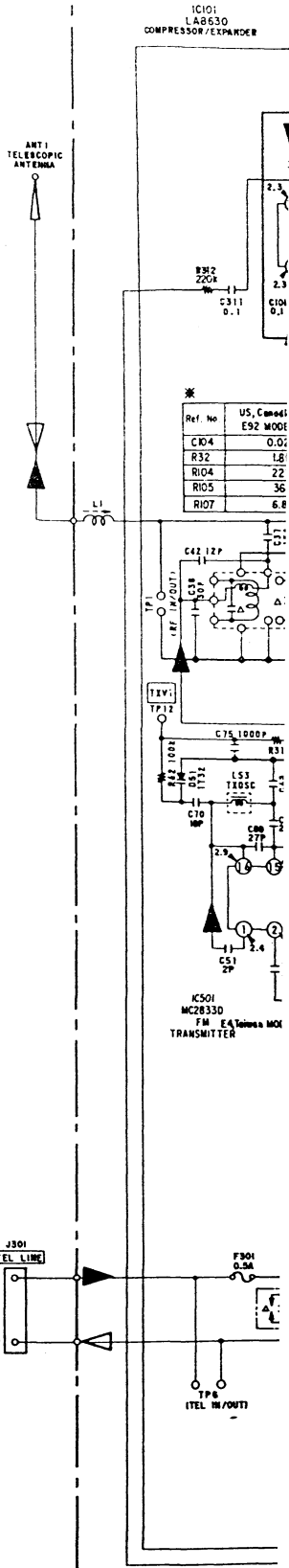

2

3

4

5

6

7

8

[BASE BOARD]

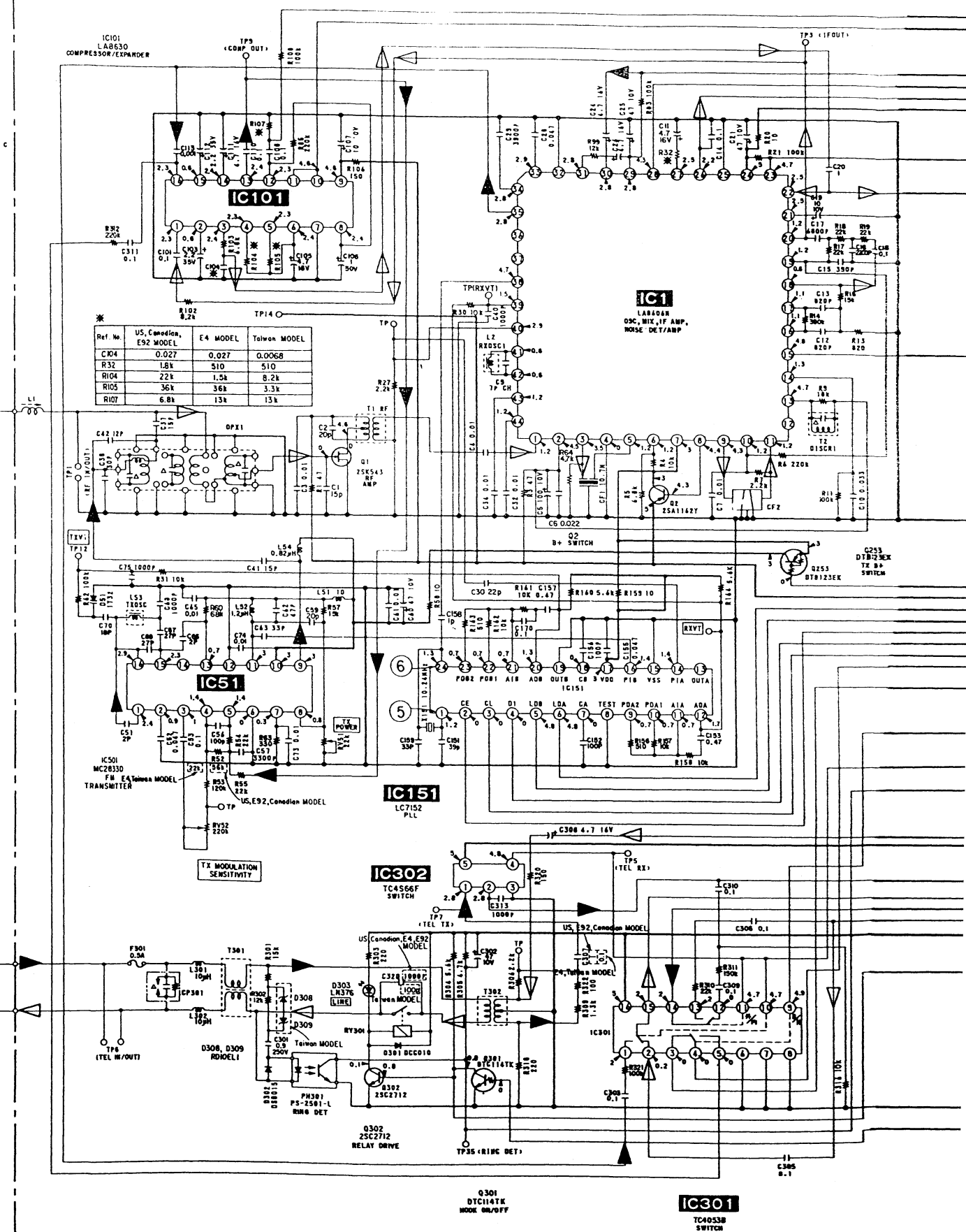

Ref. No.	US, Canadian, E92 MODEL	E4 MODEL	Taiwan MODEL
IC104	0.027	0.027	0.0068
R32	1.8k	510	510
R104	22k	1.5k	8.2k
R105	36k	36k	3.3k
R107	6.8k	13k	13k



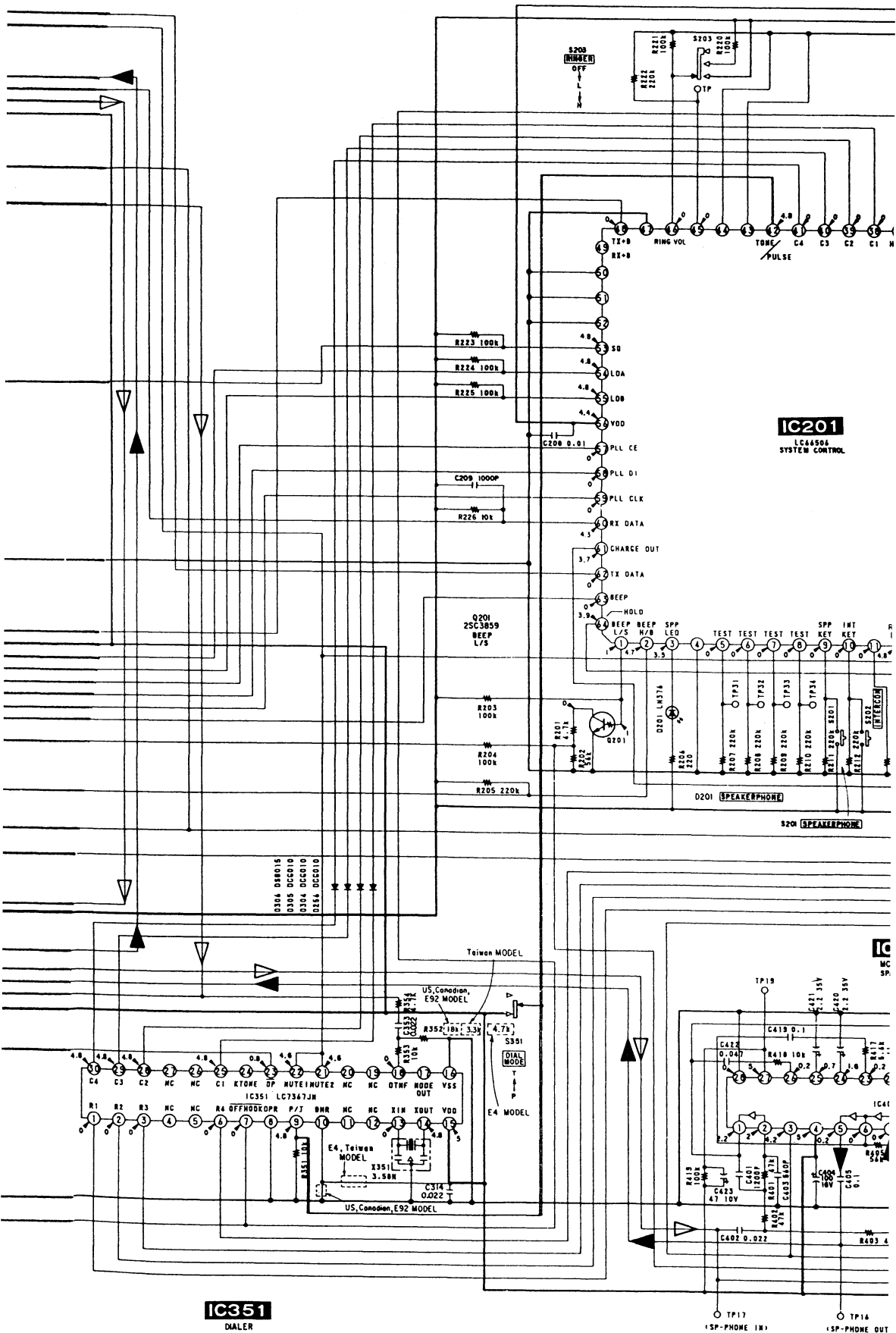

IC351 DIALER

IC201 LC44901 SYSTEM CONTROL

TP17 (SP-PHONE IN) TP14 (SP-PHONE OUT)

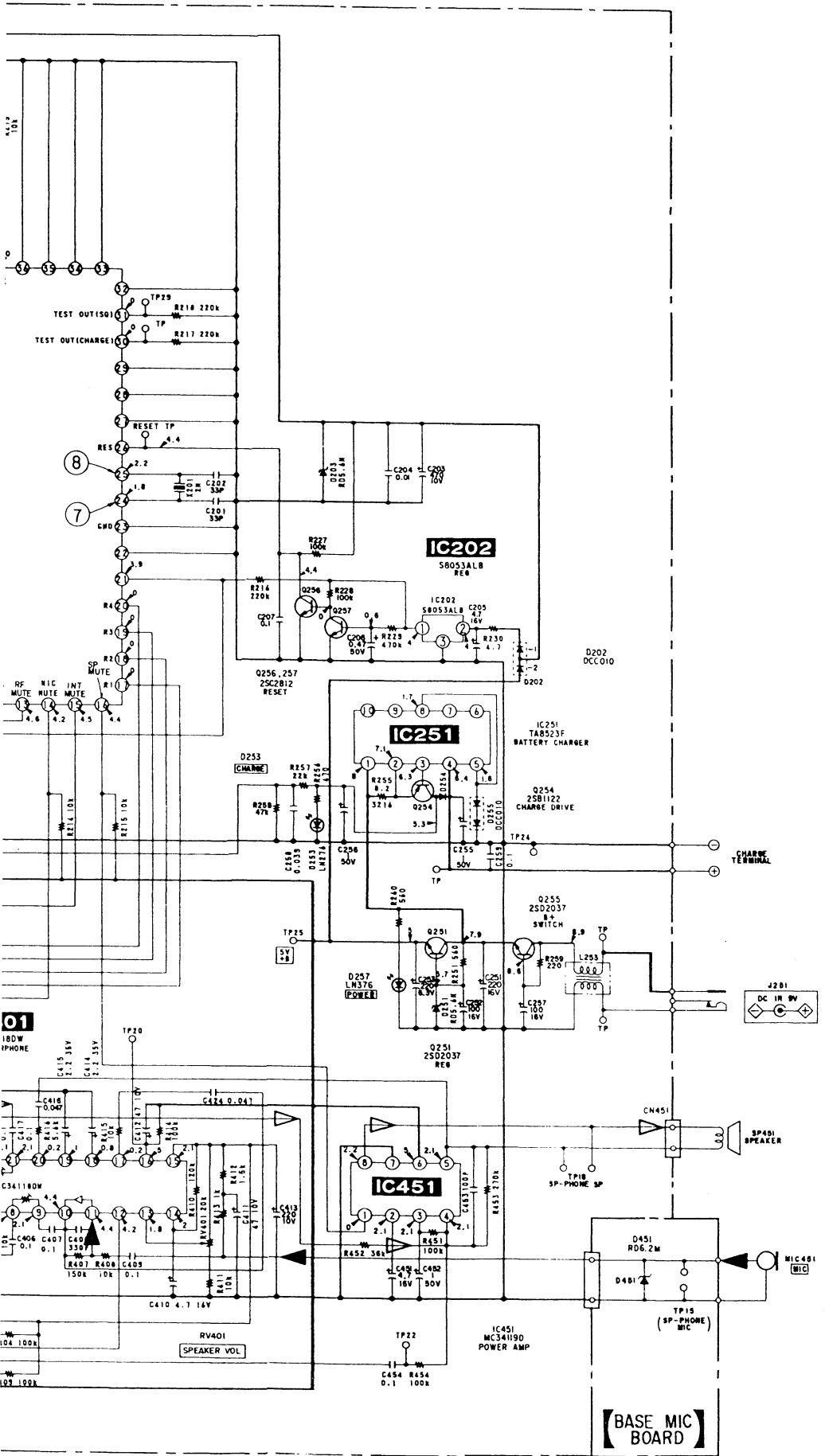

• WAVEFORMS

